

**EVGA**®

**GEFORCE**® **GTX**™  
**TITAN X / 1080 / 1070**  
**HYBRID**

Installation Guide



The following instructions and pictures are provided to assist you installation of the EVGA GTX™ TITAN X / 1080 /1070 Hybrid Cooling Kit to the NVIDIA® GeForce GTX™ TITAN X and EVGA GeForce GTX™ 1080/1070 graphics cards. Please be careful installing the hybrid, there are several very small fasteners used which can be stripped if you are not careful.

**Please be sure to keep your original thermal module and fasteners so it can be returned to how it was received in case you ever need to submit for warranty.**

All steps are that remove original thermal module, put on die-casting module, install Hybrid and then attach the shroud to finish. All suitable SKU for Hybrid installation are listed below. Please refer to the following table.

#	Graphics Cards	Part Number
A	GTX™ TITAN X	
B	GTX™ 1080	08G-P4-5180-KR
C	GTX™ 1080	08G-P4-5182-KR
D	GTX™ 1080	08G-P4-6180-KR
E	GTX™ 1080	08G-P4-6181-KR
F	GTX™ 1080	08G-P4-6183-KR
G	GTX™ 1070	08G-P4-6170-KR
H	GTX™ 1070	08G-P4-6171-KR
I	GTX™ 1070	08G-P4-6173-KR

**See the instructions below.**

1) If the model is #A, #D, #G or #E, #F, #H, #I remove the screws on the back side of the card to separate the backplate from the card. If not, please skip this step

**Founders Edition #A #D #G**



**ACX3.0 #E #F #H #I**

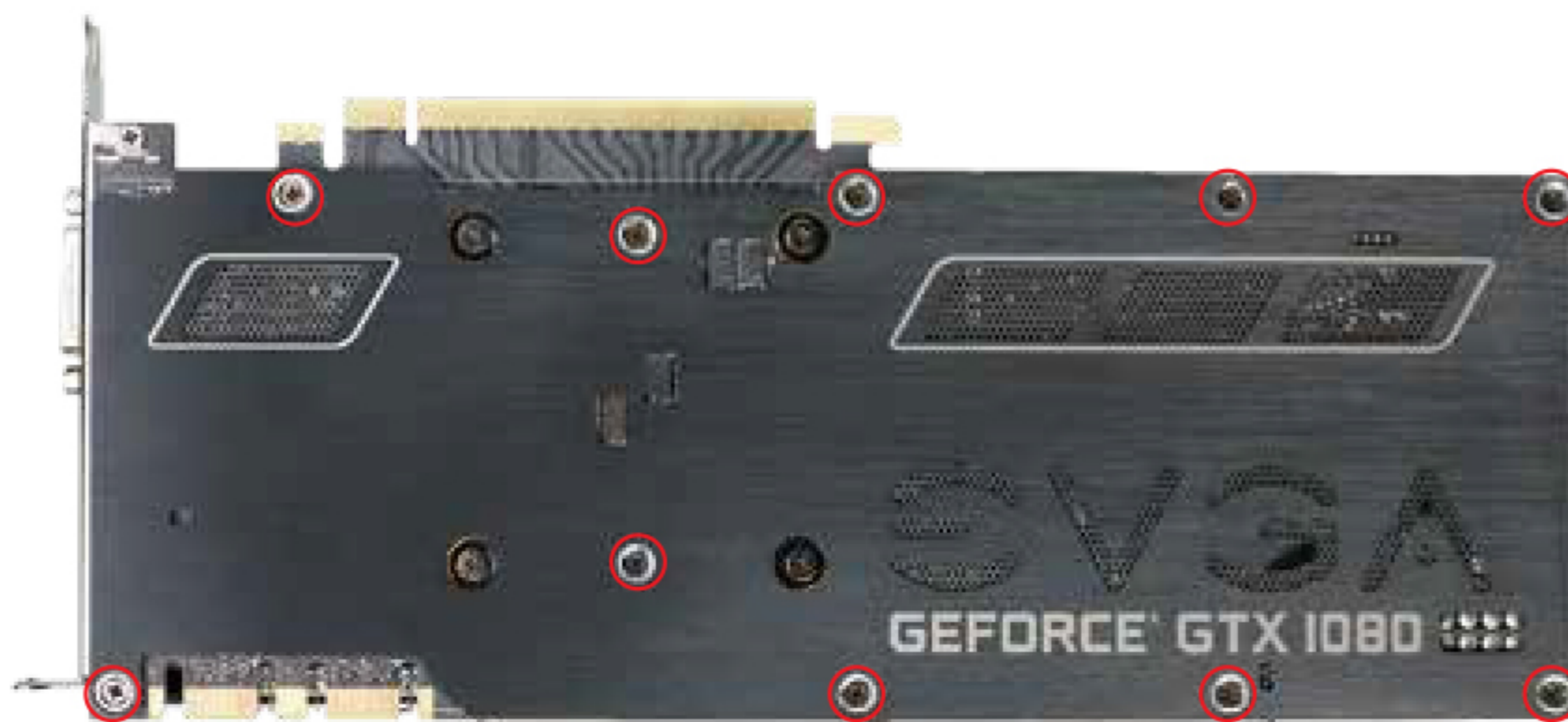

2) Remove the 4 spring screws on the back side of the card, this will allow the thermal module to be removed.

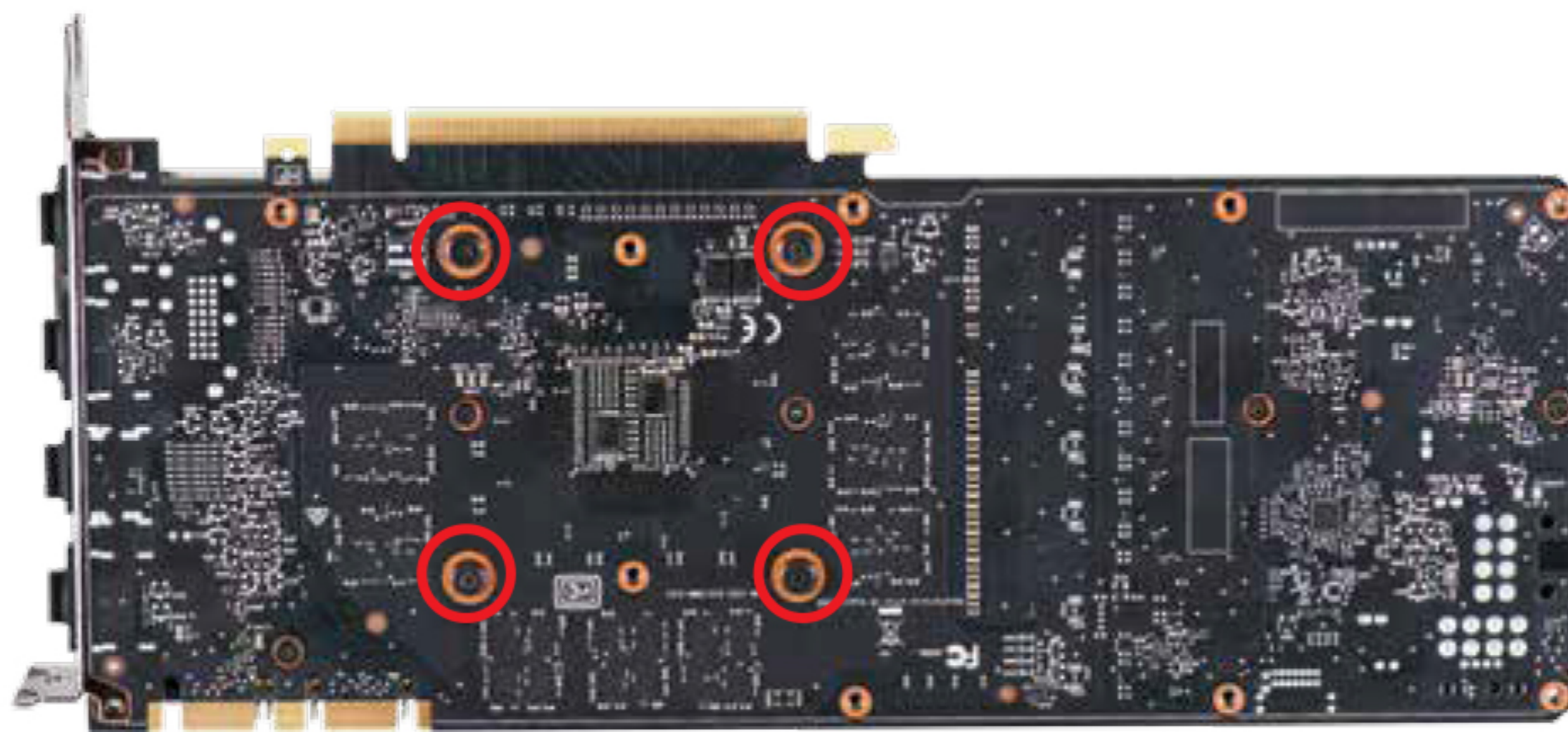
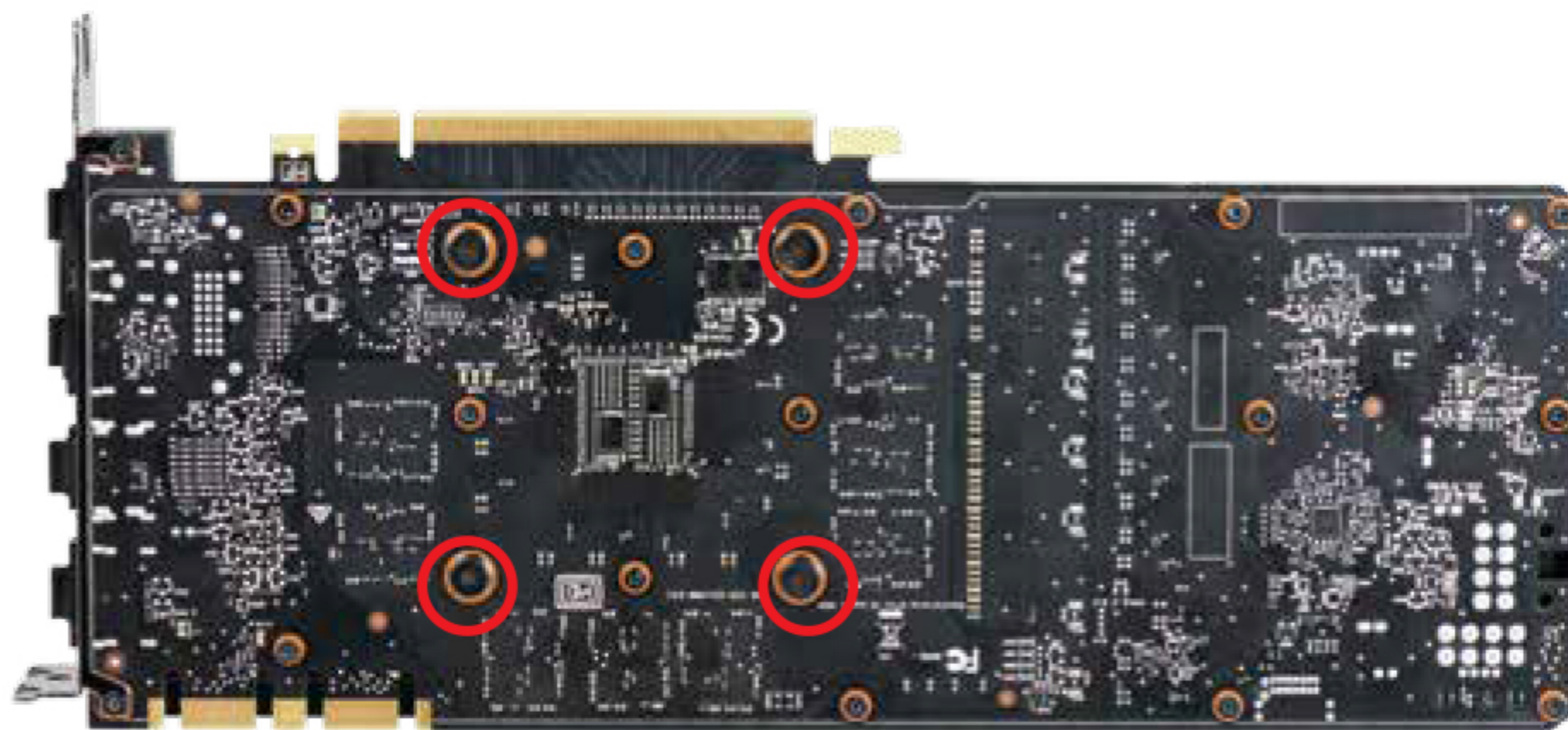

3) Remove the others screws on the back side of the card, this will allow the baseplate to be removed.

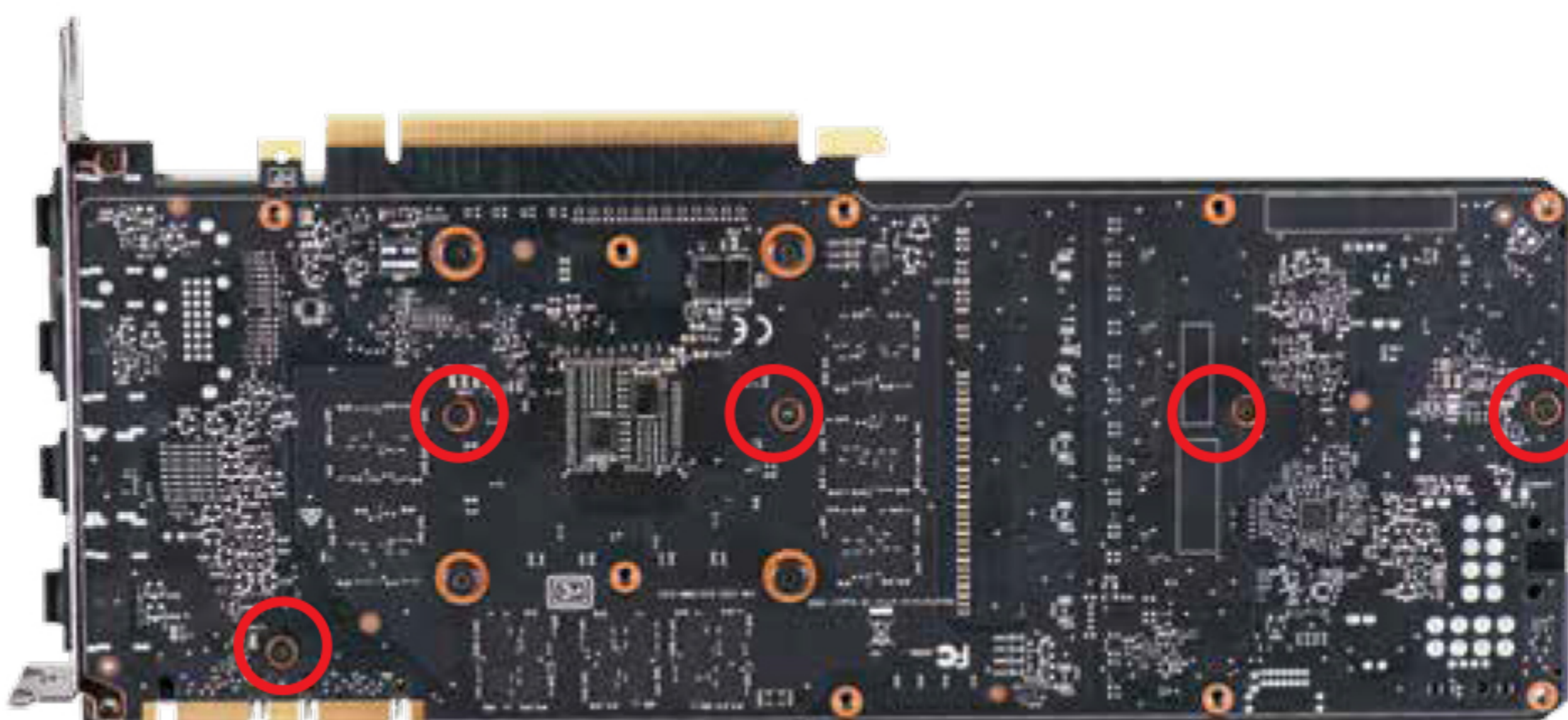
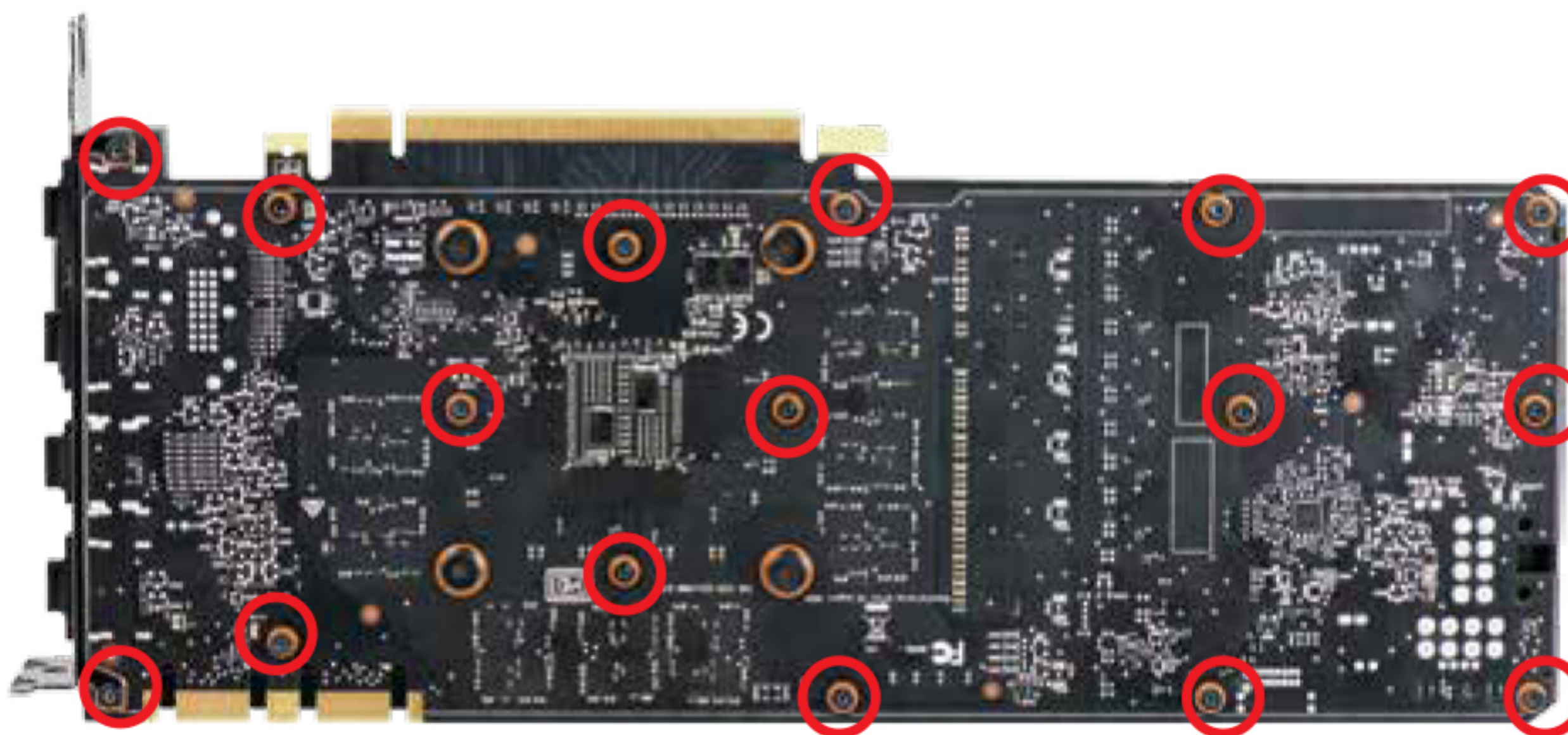

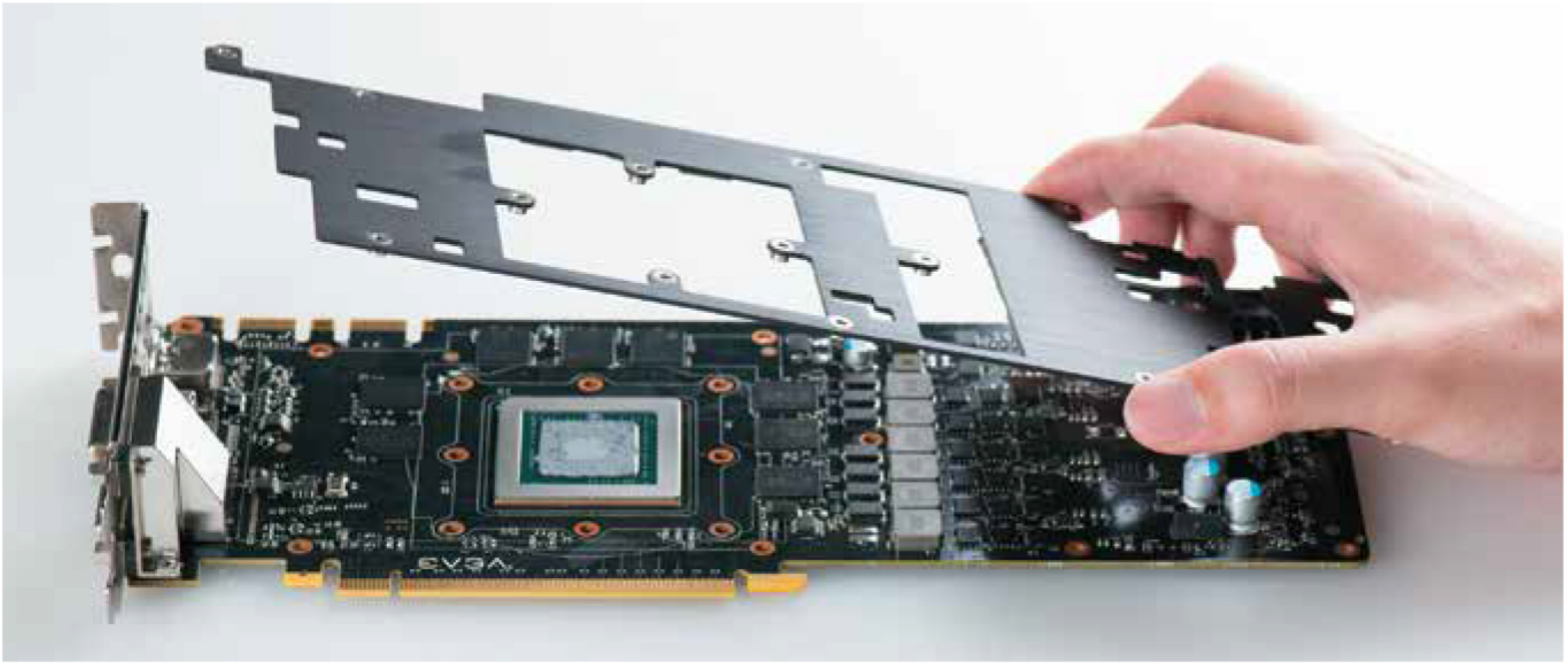

4) Be sure to clean the GPU (see pic) with alcohol (preferably 90%) removing all thermal compound.



5) Prepare HYBRID Water Cooler first, and then separate the shroud and die-casting.



6) Label the thermal pad on the PCB. The location is based on your model.

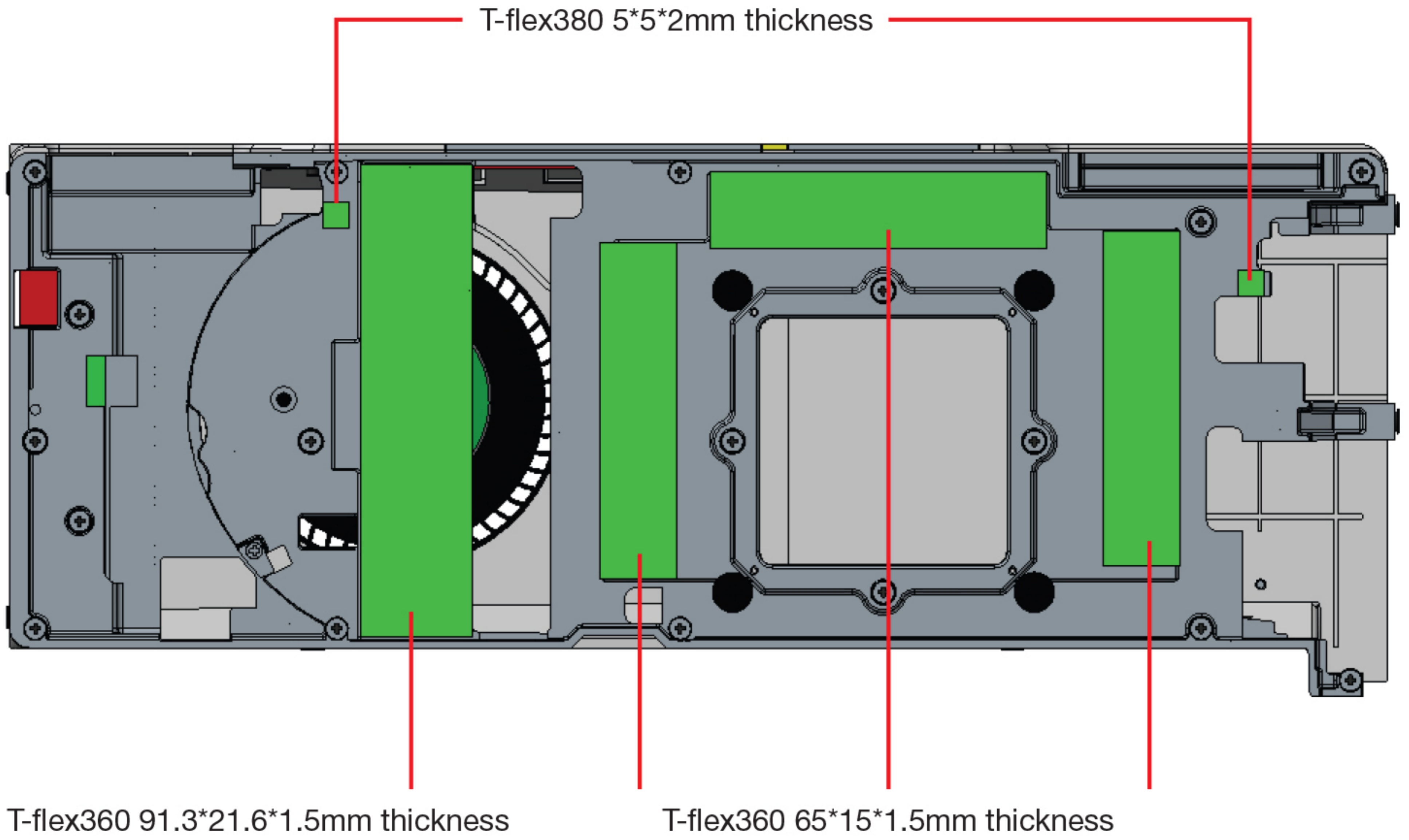

7) Put the die-casting module on the PCB.



8) Label the rubber on the sides, put the white ones on the top and black on the bottom.

Top



Bottom



- 9) The included rubber cap (see front and back picture below) is attached to the framing of the card and this is where the tubes will be held into place



- 10) Remove the plastic cap on water block, use the 4 spring screws previously removed to mount the block on the GPU (Thermal compound is pre-applied to the block).

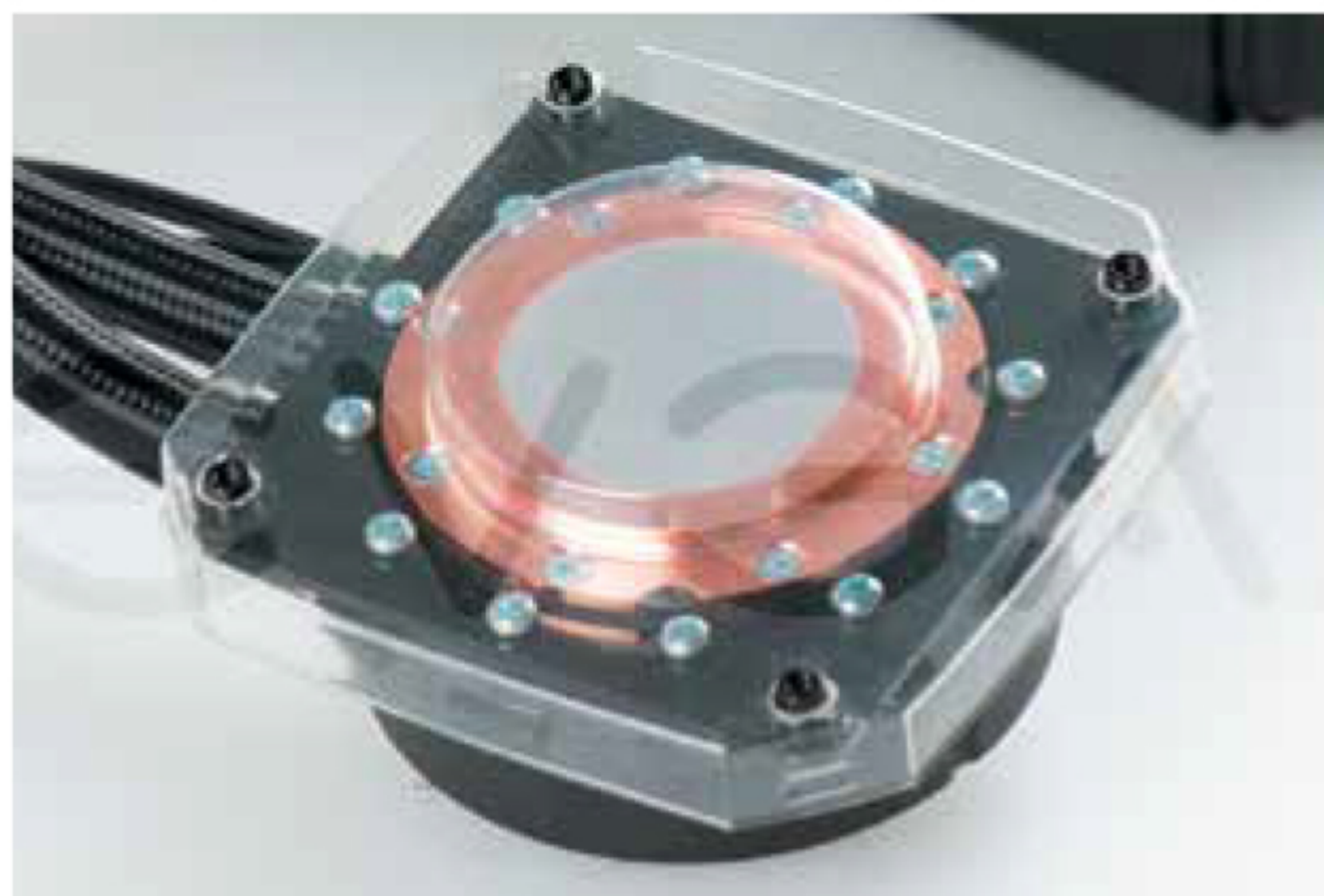

- 11) Unplug the power for the existing fan plug in the water block pass through power cable into the cards power header, then reattach the fan to the card via the pass through. Make sure the wires do not touch the fan; please use included strips of tape to attach the wires to the plastic around the perimeter of the fan.

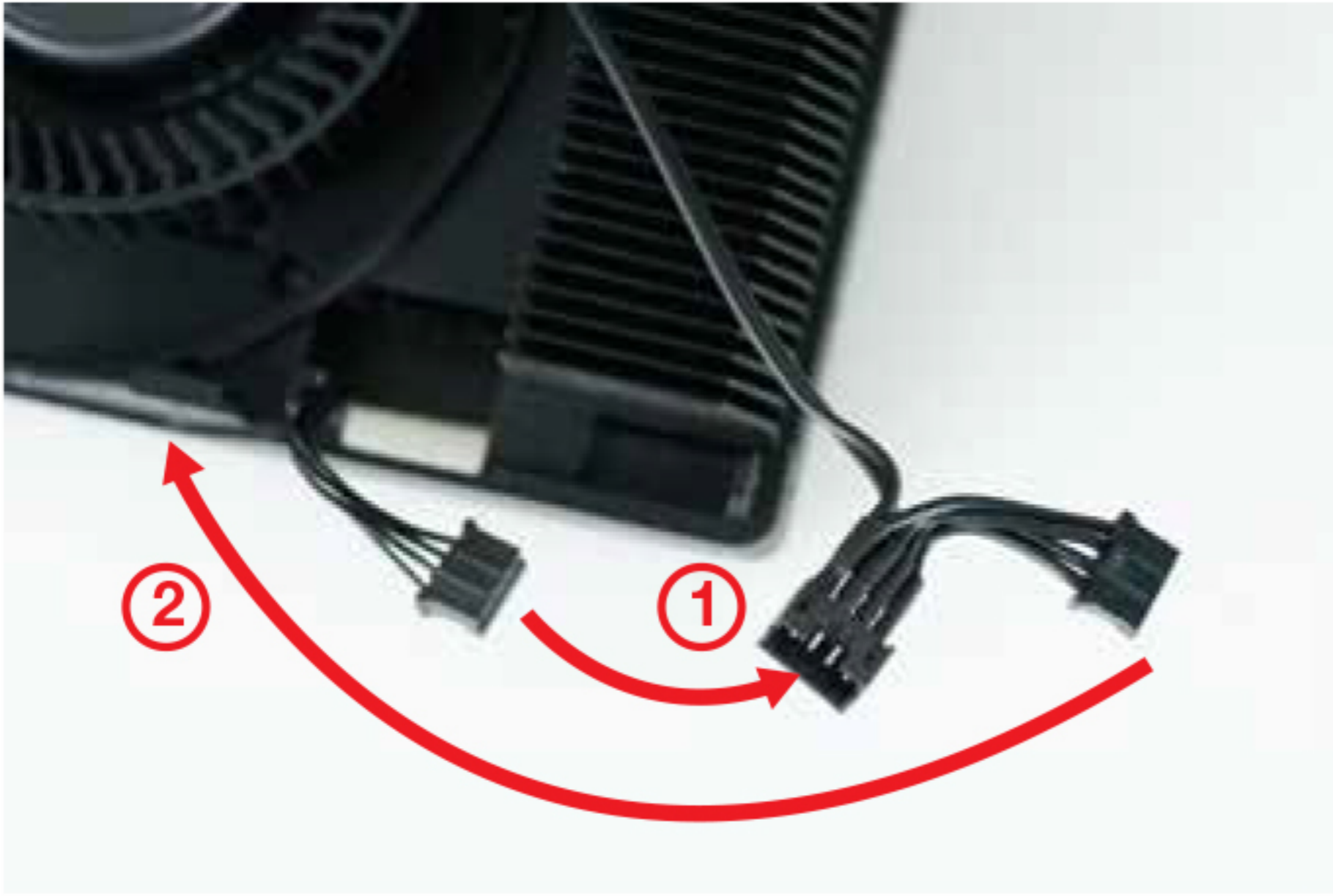



- 12) The secondary 3 pin cable from the water block powers the fan for the radiator. Attach it, and for ease of cable routing, you can use the included ties to attach the cable to the hose.



- 13) Plug LED power cable from the shroud into the card.



14) Attach the shroud to the card, you can use the hoses and the fan as alignment marks. It will use the 8 bolt holes the original shroud used. Please use the included screws for the new shroud. (#1 Philips bit)



(Bottom has 3 screws)



(Top has 3 screws)



(Side of the card has 2 screws)





