

User Guide

EVGA X79 DARK

Motherboard

Table of Contents

Before You Begin.....	4
Parts NOT in the Kit.....	5
Intentions of the Kit.....	5
Motherboard Specifications.....	6-7
Unpacking and Parts Descriptions.....	8
Equipment.....	8-9
Hardware Installation.....	10
Safety Instructions.....	10
Intel X79 Chipset Motherboard.....	11-13
Preparing the Motherboard.....	114
Installing the CPU.....	144
Installing the Cooling Device.....	155
Installing System Memory (DIMMs).....	166
Installing the Motherboard.....	17
Installing the I/O Shield.....	17
Securing the Motherboard into a System Case.....	18
Connecting Cables.....	18
24pin ATX Power (PW1).....	19
8pin ATX 12V Power.....	200
BIOS Select Switch (optional).....	20
Connecting Internal Headers.....	20
Front Panel Header.....	20
USB Headers.....	21
Audio.....	23

PCI-E x4 Slots.....	24
PCI-E x16/x8 Slots	24
Onboard Buttons	25
Clear CMOS Button.....	25
RESET and POWER Button	25
Post Port Debug LED and LED Status Indicators	26
Installing Drivers and Software	27
Windows 7/Vista/XP Driver Installation	27
POST Codes	28-32
EVGA Glossary of Terms	32-34
Compliance Information	34

Before You Begin...

The true next generation motherboards have arrived with the EVGA X79 motherboards! This product packs in the latest technologies to give you an uncompromised experience:

Uncompromised Performance – Unparalleled memory bandwidth with true quad channel DDR3 memory support, and Intel Turbo Boost Technology 2.0 gives you intelligent computing by optimizing performance on the fly! NVIDIA SLI® and PhysX give you the expansion you need to maximize your graphics performance.

Uncompromised Power – High performance PWM and POSCAP Capacitors deliver clean, optimal power to your system for maximum overclocking. Also, with built in EVGA EVBot support*, you can overclock on the fly from the palm of your hand.

Uncompromised Features – This board is loaded with the latest technologies like a full UEFI BIOS, USB 3.0 Ports, SATA III/6G support, PCI-E 3.0 ports, E-SATA, a true next generation board layout, and more!

*sold separately

Parts NOT in the Kit

This kit contains all the hardware necessary to install and connect your new EVGA X79 Dark Motherboard. However, it does not contain the following items that must be purchased separately to make the motherboard functional.

- ❑ **Intel -Socket 2011 Processor**
- ❑ **DDR3 System Memory**
- ❑ **CPU Cooling Device**
- ❑ **PCI Express Graphics Card**
- ❑ **Power Supply**

EVGA assumes you have purchased all the necessary parts needed to allow for proper system functionality. For a full list of supported CPUs on this motherboard, please visit www.evga.com/support/motherboard

Intentions of the Kit

This kit provides you with the motherboard and all connecting cables necessary to install the motherboard into a PC case.

When replacing a motherboard in a PC case, you will need to reinstall an operating system even though the current storage drive may already have one installed.

EVGA X79

Motherboard

Motherboard Specifications

- ❑ Size:
 - EATX form factor of 12 inches x 10.3 inches
- ❑ Microprocessor support:
 - Intel Socket 2011 Processor
- ❑ Operating systems:
 - Supports Windows 8 / 7 / Vista / XP
- ❑ Contains Intel X79 chipset:
- ❑ System Memory support:
 - Supports Quad channel DDR3-2400MHz+. Officially supports up to 64GB of DDR3 memory.
- ❑ USB 2.0 Ports:
 - 10x from Intel X79 PCH
 - Supports hot plug
 - Supports wake-up from S1 and S3 mode
 - Supports USB 2.0 protocol up to a 480 Mbps transmission rate
- ❑ USB 3.0 Ports:
 - 6 from Asmedia ASM1042
 - Backwards compatible USB 2.0 and USB 1.1 support
 - Supports transfer speeds up to 5Gbps

- SATA Ports:
 - Intel X79 PCH Controller
 - 4x SATA 2 Ports up to 3G (300 MB/s) data transfer rate
 - 2x SATA 3 Ports up to 6G (600 MB/s) data transfer rate
 - Support for RAID 0, RAID 1, RAID 0+1, RAID 5, AND RAID 10
 - *If 6G ports are used in the same array as 3G ports, the SATA 3 6G ports will adjust down to SATA 2 3G speeds.
 - Marvell 9230
 - 4x SATA 3 Ports up to 6G (600 MB/s) data transfer rate
 - Support for RAID 0, RAID 1, RAID 0+1, AND RAID 10
 - *Arrays **cannot** be created across Marvell and Intel controllers
 - Marvell 9172
 - 2x eSATA port on rear I/O panel
 - * Marvell controller drivers are not integrated into Windows 8 and older operating systems, and as such you will need to load drivers for this device during the Windows installation if you intend to boot off of this controller.

- Onboard LAN:
 - Intel 2x 82579/82574
 - Supports 10/100/1000 Mb/sec Ethernet
 - Supports teaming

- Onboard Audio:
 - Realtek ALC898 High-Definition audio
 - Supports 8-channel audio
 - Supports Jack-Sensing function
 - Supports Optical Output

- PCI-E Support:
 - PCI-E 2.0 Slots (PCI-E 3.0 Ready**)
 - Low power consumption and power management features

- Power Functions:
 - Supports ACPI (Advanced Configuration and Power Interface)
 - Supports S0 (normal), S1 (power on suspend), S3 (suspend to RAM), S4 (Suspend to disk - depends on OS), and S5 (soft - off)

- Expansion Slots:
 - PCI-E 16x/8x slots
 - PCI-E 4x slot
 - *Please see page 24 for a slot by slot breakdown

Unpacking and Parts Descriptions

Equipment

The following accessories are included with the EVGA X79 Dark Motherboard:



The EVGA X79 Dark Motherboard

This PCI-E motherboard contains the Intel X79 chipset and is SLI® -ready.



Visual Guide

Helps to quickly and visually guide you through the hardware installation of the motherboard.



I/O Shield

Installs in the system case to block radio frequency transmissions, protect internal components from dust, foreign objects, and aids in proper airflow within the chassis.



2-Port SATA Power Cables

Allows a Molex power connector to adapt to a SATA power connector.



4-Port USB 2.0 Bracket

Provides four additional USB ports to the back panel of the chassis.



2-Port USB 3.0 Bracket

Allows addition of 2 USB 3.0 ports by Connecting to the motherboard header.

SATA 3G/6G Data Cables



Used to support the SATA protocol and each one connects a single drive to the motherboard.

4-way SLI® Bridge



Bridges four graphics cards together which allows for 4-way SLI®.

3-way SLI® Bridge



Bridges three graphics cards together which allows for 3-way SLI®.

2-way SLI® Bridge



Bridges two graphics cards together which allows for 2-way SLI®.

Optional 1366 Backplate



Allows use of a socket 1366 cooler. This backplate is optional.

I/O Cover



This optional cover attaches to the PCB and covers the I/O area

Installation CD



Contains drivers and software needed to setup the motherboard.

User Manual



The user manual you are reading right now!

Hardware Installation

This section will guide you through the installation of the motherboard. The topics covered in this section are:

- Preparing the motherboard
- Installing the CPU
- Installing the Cooling Device
- Installing the memory
- Installing the motherboard
- Connecting cables

Safety Instructions

To reduce the risk of fire, electric shock and injury, always follow basic safety precautions.

Remember to remove power from your computer by disconnecting the AC main source before removing or installing any equipment from/to the computer chassis.

Intel X79 Chipset Motherboard

The EVGA X79 Dark Motherboard with the Intel X79 and PCH Chipset is a SLI-ready motherboard. Figure 1 shows the motherboard and Figure 2 shows the back panel connectors

FIGURE 1. X79 Dark Motherboard Layout

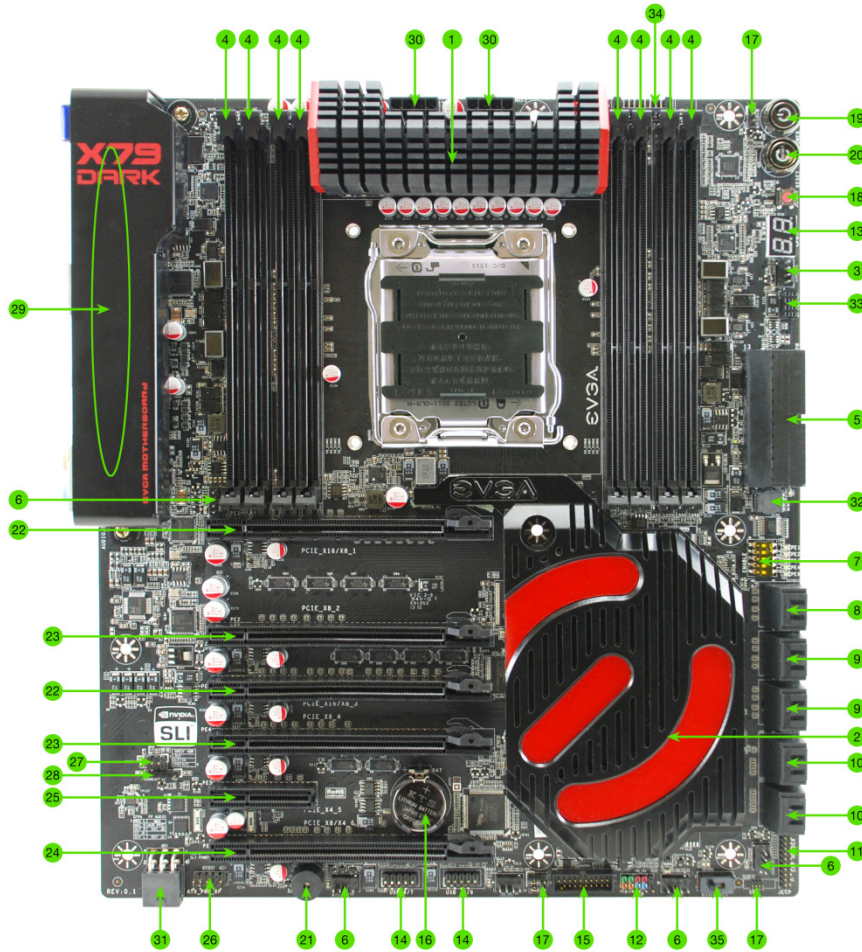

1. CPU Socket 2011	13. Debug LED	25. PCI-E Slot 4x
2. Intel X79 Southbridge	14. USB 2.0 Headers	26. Front Panel Audio Connector
3. CPU Fan Header	15. USB 3.0 Headers	27. S/PDIF Out
4. DDR3 Memory DIMM Slots 1-8	16. CMOS Battery	28. EVGauge
5. 24-pin ATX power connector	17. Unused	29. Back Panel Connectors (Figure 2)
6. Fan Headers	18. CMOS Reset Button	30. 8 pin EPS Connector
7. PCI-E Disable Dipswitches	19. Power Button	31. Supplemental PCI-E 6pin Power
8. Intel Sata 6G/3G Ports	20. Reset Button	32. Removable BIOS Chip
9. Intel Sata 3G Ports	21. PC Speaker	33. GPU Link
10. Marvell Sata 6G Ports	22. PCI-E Slot 16x/8x	34. Probe It Header
11. ECP Header	23. PCI-E Slot 8x	35. BIOS Selector Switch
12. Front Panel Connectors	24. PCI-E Slot 8x/4x	

Figure 2. Chassis Rear Panel Connectors

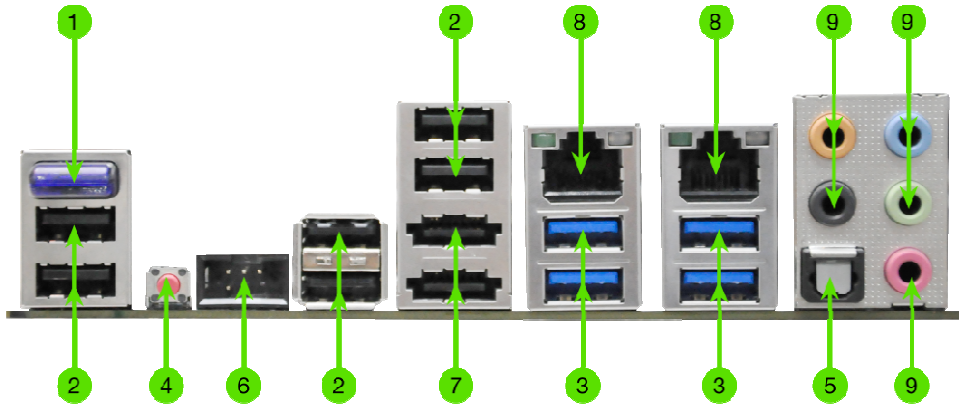

1. Bluetooth	4. CMOS Reset Switch	7. eSata Ports
2. USB 2.0	5. Optical S/DIF Out	8. NIC
3. USB 3.0	6. EVBot Connector	9. Analog Audio Output Jacks

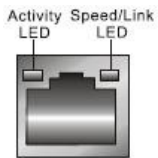

Activity LED Status	Description
Off	No data transmission
Blinking (Green)	Data transmission

Speed/Link LED Status	Description
Yellow	1000 Mbps data rate
Green	100 Mbps data rate
Off	10 Mbps data rate

Analog Audio Port Breakdown	2/2.1			
	Channel	4.0/4.1 Channel	5.1 (6 Channel)	7.1 (8 Channel)
Blue	Line in	Line In	Line in	* Side channel
Green	Line Out/ Speaker Out	Front Speaker/ Speaker+Sub Out	Front Speaker/ Speaker+Sub Out	Front Speaker/ Speaker+Sub Out
Pink	Mic In	Mic In	Mic In	Mic In
Black		Rear Speaker Out	Rear Speaker Out	Rear Speaker Out
Orange			Center/Voice channel	Center/Voice channel

* Only used in 7.1 and is changed via Realtek Software from within Windows.

Preparing the Motherboard

Installing the CPU

Be very careful when handling the CPU. Hold the processor only by the edges and do not touch the bottom of the processor.

Use the following procedure to install the CPU onto the motherboard:

- ❑ Unhook the left socket lever by pushing down and away from the socket.
- ❑ Unhook the right socket lever by pushing down and away from the socket.
- ❑ Gently press the left socket lever and the load plate will lift from the socket.
- ❑ Open the load plate and make sure not to damage any of the pins inside of the socket.

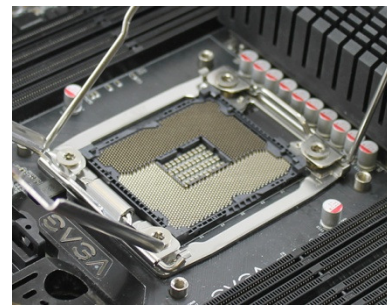
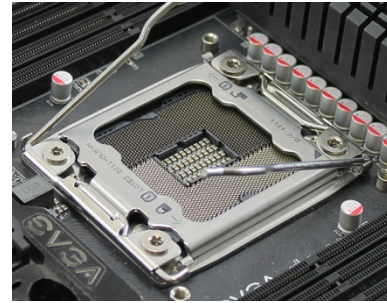

Note: After removing the CPU socket cover, it is recommended to store it in case you ever need to transport your motherboard. If you ever remove the CPU, it is highly recommended to reinstall the socket cover.

- ❑ Align the notches on the CPU to the notches in the socket.
- ❑ Lower the processor straight down into the socket.

Note: Make sure the CPU is fully seated and level in the socket.

- ❑ Lower the load plate so it is resting on the CPU.
- ❑ Press the right socket lever down to lock into place.
- ❑ Carefully lock the lever back into place.

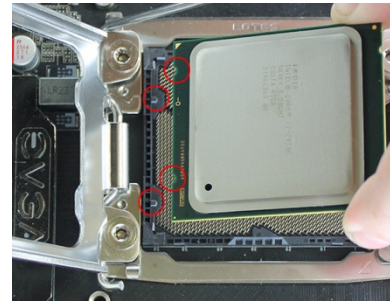

Installing the Cooling Device

There are many different cooling devices that can be used with this motherboard. Follow the instructions that come with your cooling assembly.

Installing System Memory (DIMMs)

Your new motherboard has eight 240-pin slots for DDR3 memory. These slots support 2GB, 4GB and 8GB DDR3 DIMMs. There must be at least one memory slot populated to ensure normal operation.

The Intel X79 chipset supports quad channel memory; it is required to populate slots 1,3,5,7 first. Board will not boot if slots 2,4,6,8 populated without 1,3,5,7.



Use the following procedure to install DIMMs.

Note that there is only one gap near the center of the DIMM slots. This slot matches the slot on the DIMM to ensure the component is installed properly.

- ❑ Unlock a DIMM slot by pressing the module clip outward.
- ❑ Align the memory module to the DIMM slot, and insert the module vertically into the DIMM slot. The plastic clips at top side of the DIMM slot automatically lock the DIMM into the connector.

Installing the Motherboard

The sequence of installing the motherboard into a system case depends on the chassis you are using and if you are replacing an existing motherboard or working with an empty system case. Determine if it would be easier to make all the connections prior to this step or to secure the motherboard and then make all the connections. It is normally easier to secure the motherboard first.

Use the following procedure to install the I/O shield and secure the motherboard into the chassis.

Note: Be sure that the CPU fan assembly has enough clearance for the system case covers to lock into place and for the expansion cards. Also make sure the CPU Fan assembly is aligned with the vents on the covers. This will depend on the system case being used.

Installing the I/O Shield/Cover

The motherboard kit comes with an I/O shield that is used to block internal components from dust and foreign objects, and promotes correct airflow within the chassis.

Before installing the motherboard, install the I/O shield from the inside of the chassis. Press the I/O shield into place and make sure it fits securely.

Also included is an I/O cover. This I/O cover adds a unique appearance to the I/O area of the motherboard and is completely optional. If you wish to use the cover, please place it over the I/O area, and install the chassis screws. The chassis screws are intended to hold the I/O cover down.

Securing the Motherboard into a System Case

Most system cases have a base with mounting holes you thread standoffs onto to allow the motherboard to be secured to the chassis and help to prevent short circuits. If there are studs that do not align with a mounting hole on the motherboard, it is recommended that you remove that standoff to prevent the possibility of a short circuit.

- ❑ Carefully place the motherboard onto the stand offs located inside the chassis.
- ❑ Align the mounting holes with the stand offs.
- ❑ Align the connectors to the I/O shield and/or I/O cover.
- ❑ Ensure that the fan assembly is aligned with the chassis vents according to the fan assembly instruction.
- ❑ Secure the motherboard with a recommended minimum of nine (9) screws.

Connecting Cables

This section takes you through all the necessary connections on the motherboard. This will include:

- ❑ Power Connections
 - 24pin ATX power (**PW1**)
 - 8pin ATX 12V power
- ❑ Internal Headers
 - Front Panel Header
 - USB Headers
 - Audio Header
- ❑ SATA II
- ❑ SATA III
- ❑ USB 3.0/2.0

24pin ATX Power (PW1)

PW1 is the main power supply connector located along the right edge of the board. Make sure that the power supply cable and pins are properly aligned with the connector on the motherboard. Firmly plug the power supply cable into the connector and make sure it is secure.

The 24pin Power Connector may be standard or right angled depending on your motherboard model.



Right Angled 24pin Power Connector

Connector	Pin	Signal	Pin	Signal
	1	+3.3V	13	+3.3V
	2	+3.3V	14	-12V
	3	GND	15	GND
	4	+5V	16	PS_ON
	5	GND	17	GND
	6	+5V	18	GND
	7	GND	19	GND
	8	PWROK	20	RSVD
	9	+5V_AUX	21	+5V
	10	+12V	22	+5V
	11	+12V	23	+5V
	12	+3.3V	24	GND

8-pin ATX 12V Power (PW12-1 & PW12-2)

PW12-1 & PW12-2, the 8-pin ATX 12V power connections, are used to provide power to the CPU. Align the pins to the connector and press firmly until seated. The secondary is optional for improved overclocking.

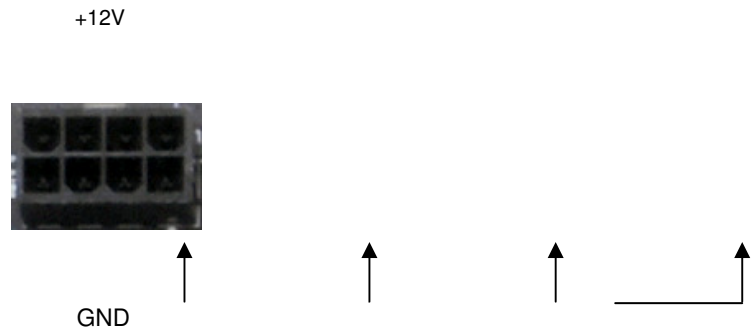

BIOS Select Switch

The BIOS Select Switch is located directly on the bottom edge of the motherboard. This jumper controls which of physical BIOS chips are to be used when the system is powered on.

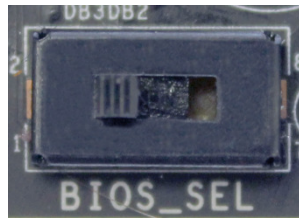

Connecting Internal Headers

Front Panel Header

The front panel header on this motherboard is used to connect the following four cables.

■ **PWRLED**

Attach the front panel power LED cable to these two pins of the connector. The Power

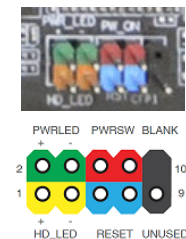

LED indicates the system's status. When the system is powered on, the LED will be on.

Note: Some system cases may not have all four cables. Be sure to match the name on the connectors to the corresponding pins.

- ❑ **PWRSW**
 Attach the power button cable from the case to these two pins. Pressing the power button on the front panel turns the system on and off rather than using the onboard button.
- ❑ **HD_LED**
 Attach the hard disk drive indicator LED cable to these two pins. The HDD indicator LED indicates the activity status of the hard disks.
- ❑ **RESET**
 Attach the Reset switch cable from the front panel of the case to these two pins.

	Pin	Signal
HD_LED	1	HD_PWR
	3	HD Active
PWRLED	2	PWR LED
	4	STBY LED
RESET	5	Ground
	7	RST BTN
PWRSW	6	PWR BTN
	8	Ground
No Connect	9	+5V
Empty	10	Empty

USB Headers

This motherboard contains USB 3.0 and 2.0 ports that are exposed on the rear panel of the chassis. The motherboard also contains 10-pin internal header connectors onboard that can be used to connect an optional external bracket containing up to four (4) USB 2.0 ports. It may also have an internal header connector for USB 3.0.

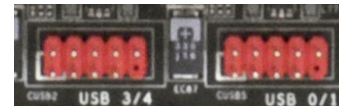

- ❑ Secure the bracket to either the front or rear panel of your chassis (not all chassis are equipped with the front panel option).
- ❑ Connect the two ends of the cables to the USB 2.0 or 3.0 headers on the motherboard.

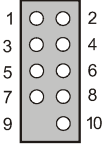
Connector	Pin	Signal	
USB 2.0 Header Connector 	1	5V_DUAL	
	3	D-	
	5	D+	
	7	GND	
	9	Empty	
	Pin	Signal	
	2	5V_DUAL	
	4	D-	
	6	D+	
	8	GND	
10	No Connect		

Audio

The audio connector supports HD audio standard and provides two kinds of audio output choices: the Front Audio and the Rear Audio.

Connector	Pin	Signal
Front Audio Connector	1	PORT1_L
	2	AUD_GND
	10 9	○ ○
	8 7	○ ○
	6 5	○ ○
	4 3	○ ○
	2 1	○ ○
	7	SENSE_SEND
	8	Empty
	9	PORT2_L
10	SENSE2_RETURN	

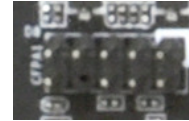

PCI-E x4 Slot

There are PCI-E x4 slots that are designed to accommodate less bandwidth-intensive cards, such as a sound or network card.

PCI-E x16/x8 Slots

These PCI-E slots are reserved for Graphics Cards and PCI-E x1, x4, x8 and x16 devices. The design of this motherboard supports multiple Graphics Card technologies such as SLI® or CrossFire.

When installing a PCI-E Graphics Card, be sure the retention clip snaps and locks the card into place. If the card is not seated properly, it could cause a short across the pins. Secure the card's metal bracket to the chassis back panel with the screw used to hold the blank cover.

PCI-E Lane Distribution

- ❑ PE1 – x16 (x8 if PE2 used)
- ❑ PE2 – x8
- ❑ PE3 – x16 (x8 if PE4 used)
- ❑ PE4 – x8
- ❑ PE5 – x4
- ❑ PE6 – x8 (x4 if PE5 used)

Onboard Buttons

These onboard buttons include RESET, POWER and Clear CMOS. These functions allow you to easily reset the system, turn on/off the system, or clear the CMOS.

Clear CMOS Button

The motherboard uses the CMOS RAM to store all the set parameters. The CMOS can be cleared by pressing the Clear CMOS button either onboard or on the external I/O Panel.

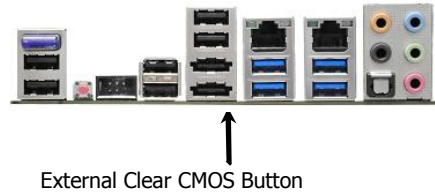

RESET and POWER Button

These onboard buttons allow you to easily turn on/off the system. These buttons allow for easy debugging and testing of the system during troubleshooting situations.

The POWER button with an integrated LED indicates the system's status. When the system is powered on, the LED remains a solid red.

The RESET button with an integrated LED indicates the activity status of the hard disk drives and will flicker accordingly.



Clear
CMOS
Button

Reset
Button

Power
Button

Post Debug LED and LED Status Indicators

Post Port Debug LED

Provides two-digit POST codes to show why the system may be failing to boot. It is useful during troubleshooting situations. This Debug LED will also display current CPU socket temperatures after the system has fully booted into the Operating System.



Debug LED with CPU
Temperature Monitor

LED Status Indicators

These LEDs indicate the system's status and are located near the 24pin connector.

❑ **POWER LED:**

When the System is powered on: This LED is on.

❑ **DIMM LED:**

When the Memory slot is functional: This LED is on.

❑ **STANDBY LED:**

When the System is in Standby Mode: This LED is on. This LED will remain on as long as the motherboard is receiving constant power.

Installing Drivers and Software

Note: It is important to remember that before installing the driver CD that is shipped in the kit, you need to load your operating system. The motherboard supports 32bit and 64bit versions of Windows 8, 7, Vista and XP.

The kit comes with a CD that contains utilities, drivers, and additional software.

The CD that has been shipped with the EVGA X79 Motherboard contains the following software and drivers:

- ❑ Chipset Drivers
- ❑ Audio Drivers
- ❑ RAID Drivers
- ❑ LAN Drivers
- ❑ USB 3.0 Drivers
- ❑ EVGA E-LEET
- ❑ User's Manual

Windows 8/7/Vista/XP Driver Installation

1. Insert the EVGA X79 installation CD for the motherboard included in the kit.
2. The CD will autorun. Install the drivers and utilities listed on the install screen. If the CD does not run, go to My Computer and click on the CD to open.

POST Codes

This section provides the AMI POST Codes for the EVGA X79 Dark Motherboard during system boot up.

The POST Codes are displayed on the Debug LED readout located directly onboard the motherboard.

This Debug LED will also display current CPU temperatures after the system has fully booted into the Operating System.



Debug LED with CPU Temperature Monitor

AMI POST Codes

01	Power on. Reset type detection (soft/hard).
02	AP initialization before microcode loading
03	North Bridge initialization before microcode loading
04	South Bridge initialization before microcode loading
05	OEM initialization before microcode loading
06	Microcode loading
07	AP initialization after microcode loading
08	North Bridge initialization after microcode loading
09	South Bridge initialization after microcode loading
0A	OEM initialization after microcode loading
0B	Cache initialization
0C-0D	Reserved for future AMI SEC error codes
0E	Microcode not found
0F	Microcode not loaded
10	PEI Core is started
11-14	Pre-memory CPU initialization is started
15-18	Pre-memory North Bridge initialization is started
19-1C	Pre-memory South Bridge initialization is started
1D-2A	OEM pre-memory initialization codes
2B	Memory initialization. Serial Presence Detect (SPD) data reading
2C	Memory initialization. Memory presence detection

2D	Memory initialization. Programming memory timing information
2E	Memory initialization. Configuring memory
2F	Memory initialization (other).
30	Reserved for ASL (see ASL Status Codes section below)
31	Memory Installed
32	CPU post-memory initialization is started
33	CPU post-memory initialization. Cache initialization
34	CPU post-memory initialization. Application Processor(s) (AP) initialization
35	CPU post-memory initialization. Boot Strap Processor (BSP) selection
36	CPU post-memory initialization. System Management Mode (SMM) initialization
37-3A	Post-Memory North Bridge initialization is started
3B-3E	Post-Memory South Bridge initialization is started
3F-4E	OEM post memory initialization codes
4F	DXE IPL is started
50	Memory initialization error. Invalid memory type or incompatible memory speed
51	Memory initialization error. SPD reading has failed
52	Memory initialization error. Invalid memory size or memory modules do not match.
53	Memory initialization error. No usable memory detected
54	Unspecified memory initialization error.
55	Memory not installed
56	Invalid CPU type or Speed
57	CPU mismatch
58	CPU self test failed or possible CPU cache error
59	CPU micro-code is not found or micro-code update is failed
5A	Internal CPU error
5B	reset PPI is not available
5C-5F	Reserved for future AMI error codes
E0	S3 Resume is started (S3 Resume PPI is called by the DXE IPL)
E1	S3 Boot Script execution
E2	Video repost
E3	OS S3 wake vector call
E4-E7	Reserved for future AMI progress codes
E8-EB	S3 Resume Failed

EC-EF	Reserved for future AMI error codes
F0	Recovery condition triggered by firmware (Auto recovery)
F1	Recovery condition triggered by user (Forced recovery)
F2	Recovery process started
F3	Recovery firmware image is found
F4	Recovery firmware image is loaded
F5-F7	Reserved for future AMI progress codes
F8	Recovery PPI is not available
F9	Recovery capsule is not found
FA	Invalid recovery capsule
FB–FF	Reserved for future AMI error codes
60	DXE Core is started
61	NVRAM initialization
62	Installation of the South Bridge Runtime Services
63-67	CPU DXE initialization is started
68	PCI host bridge initialization
69	North Bridge DXE initialization is started
6A	North Bridge DXE SMM initialization is started
6B-6F	North Bridge DXE initialization (North Bridge module specific)
70	South Bridge DXE initialization is started
71	South Bridge DXE SMM initialization is started
72	South Bridge devices initialization
73-77	South Bridge DXE Initialization (South Bridge module specific)
78	ACPI module initialization
79	CSM initialization
7A–7F	Reserved for future AMI DXE codes
80–8F	OEM DXE initialization codes
90	Boot Device Selection (BDS) phase is started
91	Driver connecting is started
92	PCI Bus initialization is started
93	PCI Bus Hot Plug Controller Initialization
94	PCI Bus Enumeration
95	PCI Bus Request Resources
96	PCI Bus Assign Resources
97	Console Output devices connect
98	Console input devices connect
99	Super IO Initialization
9A	USB initialization is started

9B	USB Reset
9C	USB Detect
9D	USB Enable
9E–9F	Reserved for future AML codes
A0	IDE initialization is started
A1	IDE Reset
A2	IDE Detect
A3	IDE Enable
A4	SCSI initialization is started
A5	SCSI Reset
A6	SCSI Detect
A7	SCSI Enable
A8	Setup Verifying Password
A9	Start of Setup
AA	Reserved for ASL (see ASL Status Codes section below)
AB	Setup Input Wait
AC	Reserved for ASL (see ASL Status Codes section below)
AD	Ready To Boot event
AE	Legacy Boot event
AF	Exit Boot Services event
B0	CPU Memory controller configuration
B1	Runtime Set Virtual Address MAP End
B2	iMC init
B3	Memory training
B4	Memory training
B5	Memory training / timing training
B6	Memory training
B7	Memory training
B8-BF	Memory training / DRAM final configuration
C0–CF	OEM BDS initialization codes
D0	CPU initialization error
D1	North Bridge initialization error
D2	South Bridge initialization error
D3	Some of the Architectural Protocols are not available
D4	PCI resource allocation error. Out of Resources
D5	No Space for Legacy Option ROM
D6	No Console Output Devices are found
D7	No Console Input Devices are found
D8	Invalid password

D9	Error loading Boot Option (LoadImage returned error)
DA	Boot Option is failed (StartImage returned error)

EVGA Glossary of Terms

AC – Alternating Current

ACPI - Advanced Configuration and Power Interface

AFR – Alternate Frame Rendering

APIC - Advanced Programmable Interrupt Controller

ACPI – Advanced Configuration and Power Interface

BCLK – Base Clock (or operating frequency of base system bus)

BIOS - Basic Input Output System

CMOS - Complementary Metal-Oxide Semiconductor

CPU – Central Processing Unit

DDR - Double Data Rate

DIMM - Dual In-line Memory Module

DMI – Direct Memory Interface

DRAM - Dynamic random access memory

DVI – Digital Video Interface

GHz – Gigahertz

GPU – Graphics Processing Unit

HDD - Hard Disk Drive

HDMI - High-Definition Multimedia Interface
HDR – High Dynamic Range Lighting
HPET - High Precision Event Timer
HT – Hyper-Threading
HSF - Heat Sink Fan
I/O - Input/ Output
IEEE - Institute of Electrical and Electronics Engineers
IGP - Integrated Graphics Processors
IMC – Integrated memory controller
IRQ - Interrupt Request
JBOD - Just a Bunch of Disks
JEDEC - Joint Electron Device Engineering Council
LAN - Local Area Network
LCD - Liquid Crystal Display
LGA – Land Grid Array
LN2 – Liquid Nitrogen Cooling
MAC - Media Access Control
MCP - Media and Communications Processor
Intel ME – Intel Management Engine
MHz – Megahertz
MMIO – Memory Mapped I/O
NB - Northbridge
NCQ - Native Command Queuing
NIC - Network Interface Card
NTFS - New Technology File System
OEM - Original Equipment Manufacturer
PATA - Parallel Advanced Technology Attachment
PCB - Printed Circuit Board
PCH – Platform Controller Hub
PCI - Peripheral Component Interconnect
PCI-E - Peripheral Component Interconnect Express

PLL – Phase Locked Loop
POST – Power on Self Test
PWM – Pulse Width Modulation
QDR - Quad Data Rate
QPI – Quick Path Interconnect
RAID - Redundant Array of Inexpensive Disks
RAM – Random Access Memory
ROM – Read Only Memory
RGB - Red Green Blue
SATA - Serial Advanced Technology Attachment
SAS – Serial Attached SCSI
SB - Southbridge
SCSI - Small Computer System Interface
SFR – Split Frame Rendering
SLI - Scalable Link Interface
SPD - Serial Presence Detect
S/PDIF - Sony/Philips Digital Interconnect Format
SPP - System Platform Processors
SSD – Solid State Drive
TCP/IP - Transmission Control Protocol/Internet Protocol
USB - Universal Serial Bus
VDroop - VCore Voltage Drop
VGA - Video Graphics Array
VREG – Voltage Regulator

Compliance Information

FCC Compliance Information

This device complies with FCC Rules Part 15. Operation is subject to the following two conditions: (1) This device may not cause harmful interference, and (2) this device must accept any interference received, including interference that may cause undesired operation. This equipment has been tested and found to comply with the limits for a Class B digital device, pursuant to Part 15 of the FCC Rules. These limits are designed to provide reasonable protection against harmful interference in a residential installation. This equipment generates, uses and can radiate radio frequency energy and, if not installed and used in accordance with the manufacturer's instructions, may cause harmful interference to radio communications. However, there is no guarantee that interference will not occur in a particular installation. If this equipment does cause harmful interference to radio or television reception, which can be determined by turning the equipment off and on, the user is encouraged to try to correct the interference by one or more of the following measures: (1) Increase the separation between the equipment and signal source, or (2) connect the equipment to an outlet on a circuit different from that to which the signal source is connected. Consult the dealer or an experienced computer technician for help. The use of shielded cables for connection of peripheral devices to the PC systems is required to ensure compliance with FCC regulations. Changes or modifications to this unit not expressly approved by the party responsible for compliance could void the user's authority to operate the equipment.

CE Compliance Information

Generic Radiation Interference Standard for Information Technology Equipment. (EN 55022: 2006, Class B), (EN 61000-3-2: 2006), (EN 61000-3-3: 1995 + A1: 2001 + A2: 2005). Warning: This is a Class B product. In a domestic environment this product may cause radio interference in which case the user may be required to take adequate measure. Generic Immunity Standard for Information Technology Equipment. (EN 55024: 1998 + A1: 2001 + A2: 2003).

Trademark & Copyright Information

2001-2013 EVGA Corp. EVGA, the EVGA logo and combinations thereof are trademarks of EVGA Corp. All brand names, company names, service marks, logos, and trademarks of the company, or its affiliates or licensors are trademarks or registered trademarks of the company or its subsidiaries, affiliates or licensors in the US and other countries. Other company, products and service names may be trademarks or service marks of others. EVGA reserves the right to terminate this license if there is a violation of its terms or default by the Original Purchaser. Upon termination, for any reason, all copies of Software and materials must be immediately returned to EVGA and the Original Purchaser shall be liable to EVGA.com CORP for any and all damages suffered as a result of the violation or default.

Legal Information

All material including but not limited to, text, data, design specifications, diagnostics, graphics, logos, reference boards, files, images, drawings, and software including this document and the software itself (together and separately) is owned, controlled by, licensed to, or used with permission by Company and is protected by copyright, trademark, and other intellectual property rights. All is being provided "as is", EVGA Corporation makes no warranties, whether express or implied, statutory or otherwise with respect to the materials and expressly disclaims all implied warranties of non-infringement, merchantability, and fitness for a particular purpose. In no event shall the liability of EVGA Corporation for claims arising from the use of the materials by anyone exceed the original purchase price of the materials (or replacement of the materials at EVGA Corporation's option). All information furnished is believed to be accurate and reliable. However, EVGA Corporation assumes no responsibility for the consequences of use of such information or for any infringement of patents or other rights of third parties that may result from its use, or use of the Software. No license is granted by implication or otherwise under any patent or patent rights of EVGA Corporation except as expressly provided herein. All specifications mentioned in this publication are subject to change without notice.

Ver. 2