

User Guide

EVGA Z490 FTW

Specs and Initial Installation

Table of Contents

| | |
|---|--------|
| User Guide | - 1 - |
| Before You Begin... | - 4 - |
| Parts NOT in the Kit..... | - 5 - |
| Intentions of the Kit..... | - 5 - |
| Motherboard..... | - 6 - |
| Motherboard Specifications..... | - 6 - |
| Unpacking and Parts Descriptions | - 8 - |
| Intel® Z490 FTW Motherboard LED reference..... | - 9 - |
| Intel® Z490 FTW Motherboard Component Legend..... | - 11 - |
| PCIe Slot Breakdown | - 23 - |
| M.2 Slot Breakdown..... | - 23 - |
| Installing the CPU | - 24 - |
| Installing the CPU Cooling Device | - 25 - |
| Installing System Memory (DIMMs) | - 26 - |
| Installing the I/O Shield..... | - 27 - |
| Installing the Motherboard..... | - 27 - |
| Securing the Motherboard into a System Case | - 28 - |
| Installing M.2 devices | - 30 - |
| Installing M.2 Key-M Socket 3 Devices | - 30 - |
| Tested CPU..... | - 33 - |
| Tested Memory..... | - 33 - |
| Tested M.2 Key-M | - 34 - |
| Tested M.2 Key-E..... | - 35 - |
| Connecting Cables..... | - 36 - |
| Onboard Buttons..... | - 49 - |
| First Boot..... | - 50 - |

M.2 SSD, PCIe SSD, and NVMe SSD Installation steps - 52 -

Internal RAID Controller - 54 -

Fan Header and PWM Setup - 90 -

Setting Up SLI and PhysX..... - 94 -

Realtek HD Audio Manager - 99 -

EVGA NU Audio - 117 -

The NU Audio Control Panel - 120 -

NU Audio Custom Settings: - 128 -

Installing Drivers and Software - 139 -

Windows 10 Driver Installation..... - 139 -

Warranty and Overclocking..... - 141 -

Troubleshooting - 142 -

Flashing the BIOS - 142 -

Flashing the BIOS Without a CPU - 145 -

SSD / HDD is not detected - 146 -

System does not POST, and POST code indicator reads “C” - 148 -

System does not POST, and POST code indicator reads “55” - 149 -

System does not POST, and POST code indicator reads “d7” - 149 -

Have a question not covered above, or want some online resources? - 150 -

Multifunction LED Indicator - 151 -

POST Beep codes - 153 -

POST Port Debug LED - 154 -

POST Codes - 155 -

EVGA Glossary of Terms - 160 -

Compliance Information - 163 -

Before You Begin...

The EVGA Z490 FTW is ready for the latest 10th Gen Intel® Core™ i9 processors. The 10th Gen Intel® Core™ desktop processor platform provides an optimal balance of frequency, cores and threads, advanced tuning support, and blazing connectivity to supercharge desktops for a competitive edge. Featuring a variety of high-speed data and storage options, display output options, 7.1 Channel Audio, and Intel® wired/wireless network options, the Z490 FTW has everything you need. This board earns its FTW with a highly-efficient Digital VRM connected to a 14 Phase power design, metal-reinforced PCIe slots, and EVGA's latest GUI BIOS featuring OC Robot and an in-BIOS stress test. The EVGA Z490 FTW is the core of everything you do next.

Furthermore, this board is designed not only for overclockers, but also for gamers by being NVIDIA® SLI® Ready and featuring blazing-fast networking, Dual M.2 Key-M slots and much more!

Lastly, a motherboard is only as good as its BIOS, and the EVGA Z490 FTW features EVGA's newest UEFI/BIOS GUI with a focus on overclocking and functionality in a lean, straightforward package. You won't need to be an expert to configure your motherboard, but if you are, you'll find features unavailable anywhere else.

Combining the best of current technology with the latest innovations, EVGA is further refining motherboard performance!

Parts NOT in the Kit

This kit contains all the hardware necessary to install and connect your new EVGA Z490 FTW Motherboard. However, it does NOT contain the following items, which must be purchased separately in order to make the system fully-functional and install an Operating System:

- ❑ **Intel® Socket 1200 Processor**
- ❑ **DDR4 System Memory**
- ❑ **CPU Cooling Device**
- ❑ **PCI-Express Graphics Card**
- ❑ **Power Supply**
- ❑ **Hard Drive or SSD**
- ❑ **Keyboard / Mouse**
- ❑ **Monitor**
- ❑ **(Optional) Optical Drive**

EVGA assumes you have purchased all the necessary parts needed to allow for proper system functionality. For a full list of supported CPUs on this motherboard, please visit <https://www.evga.com/support/motherboard>.

Intentions of the Kit

When replacing a different model motherboard in a PC case, you may need to reinstall your operating system, even though the current HDD/SSD may already have one installed. Keep in mind, however, you may sometimes also need to reinstall your OS after a RMA even if your motherboard remains the same due to issues that occurred prior to replacing the motherboard.

Motherboard

Motherboard Specifications

- ❑ **Size:**
ATX form-factor of 12 inches x 9.6 inches (305x243.8mm)
- ❑ **Microprocessor support:**
Intel® Socket 1200 Processor
- ❑ **Operating Systems:**
Supports Windows 10 64-Bit
- ❑ **Contains Intel® Z490 chipset**
- ❑ **System Memory support:**
Supports up to 128GB Dual channel DDR4 up to 4400MHz+ (OC).
- ❑ **USB 2.0 Ports:**
4x internal from 2 FP headers via Intel® Z490 USB HUB
1x from Update Port for flashing the BIOS without CPU
Supports hot plug/wake-up from S3 mode
- ❑ **USB 3.2 Gen.1 Ports:**
4x from Intel® Z490 PCH – 2x external (Type-A), 2x internal via 1 FP header
Supports transfer speeds up to 5Gbps
Backwards-compatible USB 2.0 and USB 1.1 support
- ❑ **USB 3.2 Gen.2 Ports:**
5x from Intel® Z490 PCH – 4x external (Type-A), 1x internal header
Supports transfer speeds up to 10Gbps
Backwards-compatible USB 3.2 Gen.1, USB 2.0 and USB 1.1 support
- ❑ **USB 3.2 Gen.2x2 Port:**
1x from ASMedia ASM3242 – 1x external (Type-C)
Supports transfer speeds up to 20Gbps
Backwards-compatible USB 3.2 Gen2/1, USB 2.0 and USB 1.1 support

❑ **Display Outputs:**

Display Port 1.2 / HDMI 1.4

❑ **SATA Ports:**

4x SATA 6Gbps data transfer rate / Intel® Z490 PCH Controller

- Support for RAID0, RAID1, RAID5, AND RAID10

- Supports hot plug

2x SATA 6Gbps data transfer rate / ASMedia ASM1061 Controller

❑ **Onboard LAN:**

Intel® i219V Gigabit NIC

Intel® Dual-Band WiFi / BT

❑ **Onboard Audio:**

Realtek ALC1220 High Definition Audio + EVGA NU Audio

Supports 7.1 Channel HD Audio + Optical Out

❑ **Power Functions:**

Supports ACPI (Advanced Configuration and Power Interface)

Supports S0 (normal), S3 (suspend to RAM), S4 (Suspend to disk - depends on OS), and S5 (soft - off)

❑ **PCI-Express Expansion Slots:**

1x PCIe x16/8 slot, 1x PCIe x8

1x PCIe x1 slot

❑ **PCIe 3.0 Support:**

Low power consumption and power management features

❑ **SLI and Crossfire Support:**

NVIDIA® SLI® Ready, 2-Way Crossfire

❑ **Additional Expansion Slots:**

2x M.2 Key-M 110mm slot / 1x M.2 Key-E slot

❑ **Fan Headers:**

2x 4-pin PWM controlled headers / 5x 4-pin PWM/DC controlled headers

**ALL FAN HEADERS HAVE A MAXIMUM POWER
LIMIT OF 2 AMP @ 12 VOLTS (24 WATTS)
EXCEEDING THIS LIMIT WILL CAUSE
IRREPARABLE DAMAGE TO THE BOARD.**

Unpacking and Parts Descriptions

The following accessories are included with the EVGA Z490 FTW Motherboard:



The EVGA Z490 FTW Motherboard

This motherboard contains the Intel® Z490 chipset.



I/O Shield

Installs in the system case to block radio frequency transmissions, protect internal components from dust, foreign objects, and aids in proper airflow within the chassis.



2x SATA 3G/6G Data Cables

Used to support the SATA protocol and each one connects a single drive to the motherboard.



2x Thermal Pad for M.2

Thermal Pad for attaching an M.2 Key-M SSD.



Case Badge

EVGA enthusiast case badge*.



USB Flash Drive

Contains motherboard drivers and user manual.



WiFi/BT Antenna

Connects to the pre-installed WiFi/BT module on the EVGA Z490 FTW.



Visual Installation Guide

Contains helpful steps to get your system up and running!

*Included decals, labels and case badges may vary over time, and the images used are merely reflective of the decal/label/badge designs typically included. EVGA reserves the right to change, modify, or remove decals, labels, and case badges at its discretion, at any time.

Intel® Z490 FTW Motherboard LED reference

The EVGA Z490 FTW Motherboard has an LED to indicating power, connectivity, and activity. Below is the location of the LED and its function.

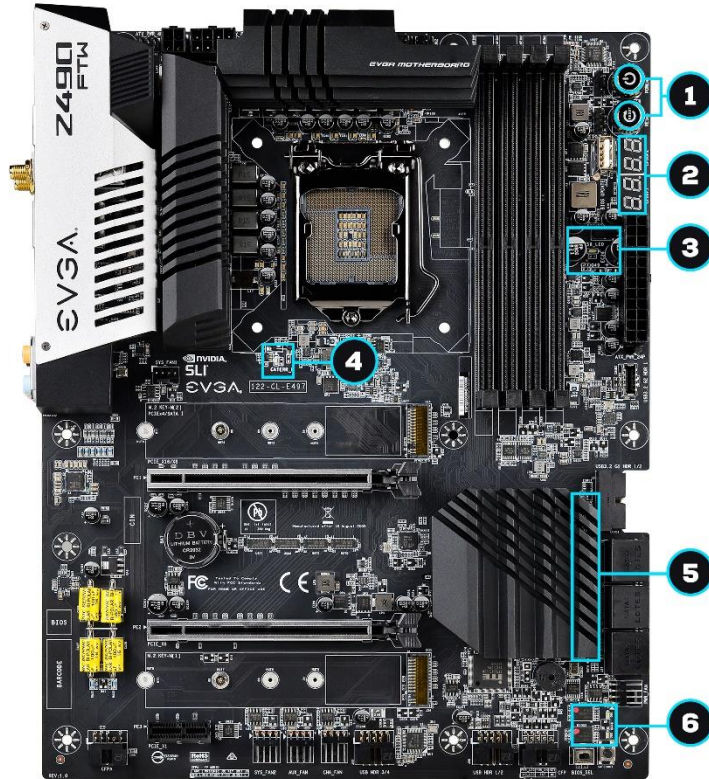

| LED Component Legend | | |
|--------------------------------|---------------|---------------------|
| 1. Power /Reset Buttons | 3. +5VSB | 5. Onboard ARGB LED |
| 2. POST LED Indicator /Monitor | 4. CATERR_LED | 6. Active BIOS LED |

1. Power / Reset Buttons
 - a. Power Button
 - i. RED: Motherboard is turned on and running
 - b. Reset Button
 - i. White: Reset button will typically flash in conjunction with HDD/SSD LED. Depending on load, the button may flash or appear solid white at times.
 - ii. NVMe SSDs cannot be read for the purposes of the Reset LED.
2. Multifunction POST Indicator
 - a. During boot it will cycle many different hexadecimal post codes with a range of 00-FF and this indicates what aspect of the Power On Self Test (POST) is currently running.
 - i. For a list of POST Codes, please see Page 155.
 - ii. This indicator can be configured in BIOS to display hardware monitoring information, such as voltage or temperature. After boot, these LEDs will show either temperature or voltage, depending on user configuration in the BIOS.
3. +5VSB
 - a. White: Voltage present (Does not mean PSU is outputting in-spec, only that this specific voltage is detected)
4. CATERR_LED - Catastrophic Error on the processor
 - a. RED: Processor error has occurred.
 - b. OFF: No error state detected in the CPU.
5. Active BIOS LED
 - a. BIOS 1
 - i. WHITE: BIOS 1 chip is active
 - ii. OFF: BIOS 2 chip is active
 - b. BIOS 2
 - i. WHITE: BIOS 2 chip is active
 - ii. OFF: BIOS 1 chip is active
6. Onboard ARGB LED
 - a. Located around the PCH heatsink, the LEDs can be directly controlled via EVGA ELEET X1. Choose the LED colors and patterns, or turn off in the software.

Intel® Z490 FTW Motherboard Component Legend

The EVGA Z490 FTW Motherboard with the Intel® Z490 and PCH Chipset. Figure 1 shows the motherboard and Figure 2 shows the back panel connectors.

FIGURE 1. Z490 FTW Motherboard Layout

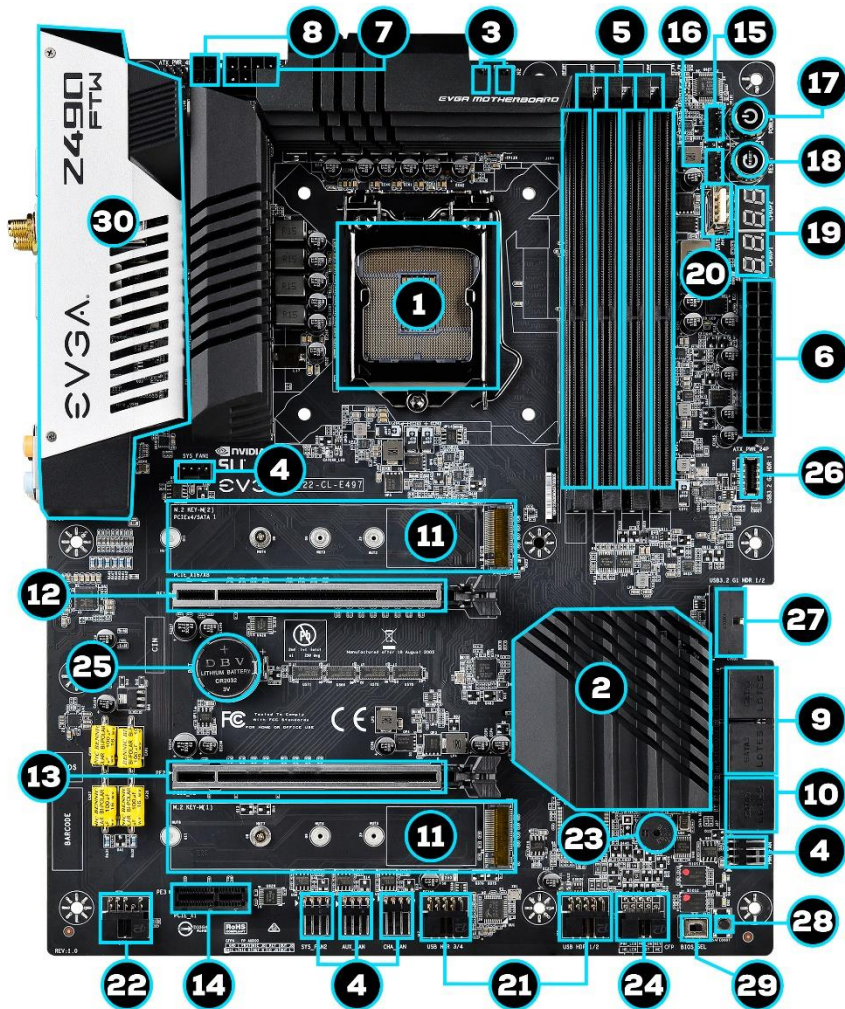

**For a FULL description of the above legend, please see Page 14.

| Component Legend | | |
|-------------------------------------|---------------------------------|--------------------------------------|
| 1. CPU Socket 1200 | 11. M.2 Socket 3 Key-M 110mm | 21. USB 2.0 Headers |
| 2. Intel Z490 PCH | 12. PCIe Slot x16/x8 | 22. Front Panel Audio Connector |
| 3. PWM Fan Headers (1 amp) | 13. PCIe Slot x8 | 23. PC Speaker |
| 4. DC / PWM Fan Headers | 14. PCIe Slot x1 | 24. Front Panel Connectors |
| 5. DDR4 Memory DIMM Slots | 15. ARGB LED Controller Header | 25. CMOS Battery |
| 6. 24-pin ATX power connector | 16. RGB LED Controller Header | 26. USB 3.2 Gen2 Header (Type-C) |
| 7. 8-pin EPS Connector | 17. Power Button | 27. USB 3.2 Gen1 Header |
| 8. 4-pin Supplemental ATX Connector | 18. Reset Button | 28. BIOS SafeBoot Button |
| 9. Intel® SATA 6G Ports | 19. POST Indicator / HW Monitor | 29. BIOS Selector Switch |
| 10. ASMedia SATA 6G Ports | 20. USB to SPI for BIOS Flash | 30. Rear Panel Connectors (Figure 2) |

Figure 2. Chassis Rear Panel Connectors

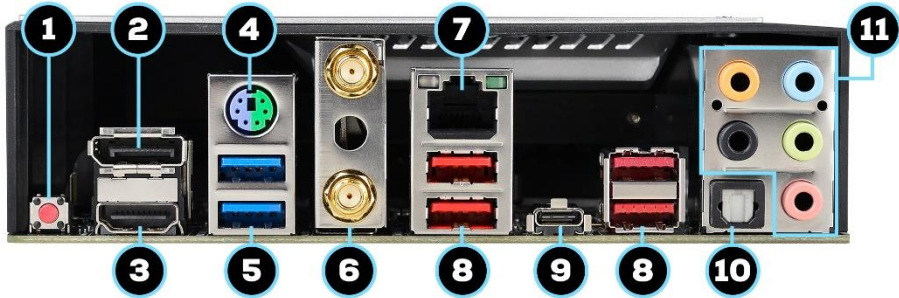

| I/O Hub Legend | | |
|---------------------|---------------------------|------------------------|
| 1. BIOS /CMOS Reset | 5. USB 3.2 Gen1 Ports | 9. USB 3.2 Gen2x2 Port |
| 2. Display Port 1.2 | 6. Integrated WiFi Module | 10. Optical Out |
| 3. HDMI 1.4 | 7. Intel i219V NIC | 11. Analog Audio Jacks |
| 4. PS/2 Port | 8. USB 3.2 Gen2 Ports | |



| SpeedLink LED Status | Description |
|----------------------|---------------------|
| Orange | 1000 Mbps data rate |
| Green | 100 Mbps data rate |
| Off | 10 Mbps data rate |

| Activity LED Status | Description |
|---------------------|----------------------|
| Off | No data transmission |
| Blinking (Green) | Data transmission |

| 3.5mm Audio Jack Legend | | | | |
|---|---|---|--------------------|--------------------|
| Analog Audio Port Breakdown | 2/2.1 Channel | 4.0/4.1 Channel | 5.1 Channel | 7.1 Channel |
| Blue | Line In | *Rear Speakers Out | Line In | *Rear Speakers Out |
| Green | Front Speakers Out / Front Speakers +Sub | Front Speakers Out / Front Speakers +Sub | Front Speakers Out | Front Speakers Out |
| Pink | Mic In | Mic In | Mic In | Mic In |
| Black | | | Side Speakers Out | Side Speakers Out |
| Orange | | | Center / Sub Out | Center / Sub Out |
| * Only used in 7.1 and is changed via Realtek Software from within Windows. | | | | |

Component Legend Descriptions

1. CPU Socket 1200

This is the interface for the Central Processing Unit (CPU), and supports Core i5, Core i7, and Core i9 models compatible with the Intel® 1200 Socket and Comet Lake-S architecture.

2. Intel® Z490 PCH (Southbridge)

The Platform Controller Hub (PCH) handles the role that was previously held by the South Bridge. The PCH has 4 PCIe Gen 3 lanes and allocates bandwidth to smaller PCIe slots, M.2, USB, audio, etc. In simplified terms, the PCH works as a hub for peripherals that are less bandwidth-intensive.

3. PWM Fan Headers (CPU1 and CPU2)

4-pin fan headers that control the fan speed based on a configurable curve or static percentage. PWM (Pulse-Width Modulation) works by pulsing power to the fan at a constant rate and sending the RPM signal to the fan's controller via a Sense cable, rather than adjusting fan speed by increasing and decreasing voltage. This method is preferable because it eliminates voltage-based fan stall points. Please see Page 90 for a more in-depth PWM breakdown and PWM controls within BIOS/UEFI.

These headers also support 12v. DC fans. However, DC fan speed is based on decreasing voltage to the fan, starting at a default of 100%/12V. When using a 12v. fan, the minimum speed will vary depending on the motor because most fan motors require a set amount of voltage before stalling.

4. PWM/DC Fan Headers

These ports may be used with both PWM and DC fans and may be controlled via Smart Fan or manually within the BIOS.

5. DDR4 Memory Slots

The memory slots support up to four 288-pin DDR4 DIMMs in Dual-Channel mode. Dual-Channel mode will be enabled only upon using two or four sticks of supported memory, according to the installation guide above. Using one or three sticks of memory will lower the board to Single-Channel mode, which may significantly lower performance. Memory kits marketed as "Quad-Channel" *MAY* work; however, the kit will continue to run in Dual-Channel mode due to the limitations of the CPU's memory controller. 128GB of RAM is supported in a 4x32GB configuration. At the time of this manual's release, this motherboard officially supports up to 4400MHz+ speeds. These speeds

cannot be guaranteed, however, because Intel® only certifies the speed of the memory controller up to 2933MHz for Comet Lake-S processors.

6. 24-pin ATX power connector

The main power for the motherboard is located on the right side of the board and perpendicular to the PCB; this is also described as a “Vertical” connector (See Page 37 for more specifics to the connector itself, and associated wiring/pinouts). The 24-pin connector IS directional and the connector needs the tab on the socket to line up with the release clip located on the 24-pin connector from the power supply. This connector pulls the bulk of the power for all components. Other connectors, such as EPS and ATX, have been added to reduce the load and increase longevity due to wiring and trace limitations.

7. 8-pin EPS Connector

The EPS is dedicated power for the CPU (See Page 38 for more specifics to the connector itself, and associated wiring/pinouts). Carefully choose the correct power cable by consulting with the installation manual for your power supply. This connector is designed to only work with an EPS or CPU cable. System builders sometimes make the mistake of plugging in a PCIe 8-pin or 6+2-pin connector, which will prevent the board from completing POST and possibly short or damage the board. Although PCIe and EPS cables appear similar, they are wired differently and attaching the wrong connector may cause damage to the motherboard.

Alternatively, if no power cable is connected or detected, the system will not POST and will hang at POST code “C.”

8. 4-pin Supplemental ATX Connector

The ATX power connector on the Z490 FTW provides additional power to the CPU. This connector requires the appropriate 4-pin ATX power that is provided by your power supply – often as part of a 4+4-pin CPU connector. (See Page 36 for more specifics to the connector itself, and associated wiring/pinouts). This connector is not essential to running the system, but may provide additional power to the CPU under a heavy load, overclocking, and/or benchmarking. The 4-pin power connector may be installed *in addition* to the 8-pin EPS connector; it may not be installed *in place* of the 8-pin EPS connector.

9. Intel® SATA 6G Ports

The Intel® Z490 PCH has a 4-port SATA 3/6G controller (See Page 48 for specifics on the connectors). This controller is backwards compatible with SATA and SATA 2 devices, and supports SSDs, HDDs and various types of optical devices (CDROM, DVDROM, BD-ROM, etc.). The controller also

supports NCQ, TRIM, hot swap capability (provided the proper HDD/SSD bays/racks are installed), and RAID levels 0/1/5/10.

10. ASMedia SATA 6G Ports

This is a secondary SATA controller, the ASM1061 is a 2-port SATA3/6 Gbit/s controller with legacy support for older operating systems. This is included largely for benchmarking and overclocking with very specific programs, such as Super Pi, 3DMark, PCMark, etc. This board is not guaranteed to fully support any OS prior to Windows 10 x64, as we offer no drivers for legacy OS (See Page 48 for specifics on the connectors).

11. M.2 Socket 3 Key-M 110mm

M.2 is an SSD standard, which uses up to four PCIe lanes and utilizes Gen3 speeds. Most popularly paired with NVMe SSDs, this standard offers substantially faster transfer speeds and seek time than SATA interface standards. All M.2 devices are designed to connect via a card-bus style connector, secured by bolting into place, and powered by the connector – rather than a dedicated data cable and power cable.

M.2 Key-M (1) supports PCIe devices, while M.2 Key-M (2) supports both PCIe and SATA devices.

This socket will support Key-M devices of 110mm, 80mm, 60mm, and 42mm length.

12. PCIe Slot x16/x8

PCIe x16/x8 slots are primarily for video cards. These full-length slots will provide 8 or 16 lanes of bandwidth to a full-size card, and are backwards-compatible with x8, x4, and x1-length cards.

Comet Lake-S Socket 1200 processors have 16 PCIe lanes available for routing. The 16 PCIe lanes are pulled from the CPU and shared with the x16 PCIe slot 2 (PE2). Lanes automatically switch from x16/x0 to x8/x8 when the motherboard detects a card in slot PE2.

13. PCIe Slot x8

PCIe x16/x8 slots are primarily for video cards. These full-length slots will provide up to 8 lanes of bandwidth to a full-size card, and are backwards compatible with x8, x4, and x1 length cards.

This slot is limited to a maximum of 8 lanes as it shares bandwidth with the primary PCIe x16 slot 2 (PE1). This slot is primarily recommended for secondary video cards, such as the 2nd card in a SLI configuration, or a PhysX card.

* Please see the description for Physical (length) vs Electrical (lanes) on Page 21.

14. PCIe Slot x1

PCIe x1 is the smallest form-factor PCIe card slot. They are all one lane and are used for low-bandwidth products.

15. ARGB LED Controller Header

The ARGB header is a 5V. 3 pin header with a current limit of 2A; anything above 2A will trigger overcurrent protection and lock at 2A. This header allows for far more flexible options to configure your RGB lighting via software-based control within Windows via EVGA ELEET X1, and supports up to 125 LEDs. Please see Page 42 for header specifics, and Page 137 for control options in ELEET X1.

16. RGB LED Controller Header

The RGB header is a 12V. 4 pin header with a current limit of 2A; anything above 2A will trigger overcurrent protection and lock at 2A. This header allows for software-based control within Windows for RGB devices via EVGA ELEET X1. Please see Page 43 for header specifics, and Page 137 for control options in ELEET X1.

17. Power Button

This is an onboard power button, and may be used in place of, or in conjunction with, a front panel power button wired to the board.

Benching systems, or test benches before final assembly, are best served by using the onboard power because it removes the need to wire a Power/Reset button or cross posts with a screwdriver, which is a semi-common practice. This button provides a safer and easier option than jumpering the Power posts.

18. Reset Button

This is an onboard system reset button, and may be used in place of, or in conjunction with, a front panel system reset button wired to the board.

Benching systems, or test benches before final assembly, are best served by using the onboard power because it removes the need to wire a Power/Reset button or cross posts with a screwdriver, which is a semi-common practice. This button provides a safer and easier option than jumpering the Power posts.

19. Debug POST Indicator / Hardware Monitor

This is a four-digit POST code reader, which displays in sets of 7-digit LED. The display can be configured to show data in regular decimal format, or hexadecimal, which means the characters available (when working as intended) are 0-9, A-F and has a cap of 255 characters.

During POST, the left set of LEDs will display the various POST codes as they cycle through the Power On Self-Test. The POST codes are listed in the troubleshooting section on Page 155.

After the system boots, these same set of LEDs can be set to display a hardware monitoring sensor, such as the CPU temperature in Celsius. This temperature is specifically for the CPU socket, which will typically read slightly higher than a given CPU core. To read this temp in Fahrenheit, take the value in Celsius, multiply by 9/5 (or 1.8) and add 32.

The display can be used to show additional temperatures, or can be configured in tandem with all 4 digits to provide live readings for voltages or temperatures. For example, the LEDs can be configured to read voltages, such as 1.258 or -55C for CPU temp for when you are using LN2 extreme cooling. Detailed configuration instructions for the Debug Indicator are provided on Page 151.

20. USB to SPI for BIOS Flash

This USB Update Port is designed to connect directly to the motherboard to allow the motherboard BIOS to be flashed, even if no CPU is installed. For more information on how to flash your BIOS using this method, please see Page 144.

21. USB 2.0 Headers

The USB2.0 header is used to connect additional USB interface plugs to the motherboard; these headers are most often used to connect the motherboard to the chassis to enable the USB2.0 ports on the chassis. These will function similarly to the USB2.0 ports found on the motherboard's hardwired I/O hub, but these can also be used for the chassis' front panel USB, auxiliary ports that mount in the card slots, and certain devices that directly connect to the header.

USB 2.0 standard is 500ma @ 5V per port (header total is 1000ma) for unpowered devices. If your USB device requires more power, it is recommended to attach a powered USB Hub.

22. Front Panel Audio Connector

This motherboard header is used to plug in the audio cable included with most PC chassis. This connector is required for audio recording and/or playback via the audio connectors on the chassis. This header has a connector that looks similar to the USB2.0 header and uses the standard “HD Audio” jack. Some chassis may provide two headers: one labeled HD Audio, and one labeled AC’97 – an AC’97 cable is **not** compatible with this header on the Z490 FTW.

23. PC Speaker

This is a small mono low-fidelity speaker, which is permanently attached to the motherboard. Its primary use is for debugging purposes. A POST beep may indicate a successful POST or various tones for USB initialization, while other beeps may indicate an issue during the POST process. Please see Page 153 for more details.

24. Front Panel Connectors

The Front Panel Connectors are the four main chassis connections. These include the Power Switch, Power LED, Reset Switch, and HDD LED. The Power and Reset switches are “Momentary Switches,” rather than “Latching Switches,” which means the connection between two posts only needs a brief moment to turn on the device, as opposed to requiring a constant connection. For example, the Power and Reset switches can be triggered instantly with a screwdriver by simultaneously touching the + and - posts.

The Power LED will power on with the system, indicating the system is on and can blink in conjunction with CPU activity.

HDD LED will blink during access to the SATA ports; this is not activated for M.2 SSDs.

25. CMOS Battery

The CMOS battery backup provides uninterruptable power to the BIOS/UEFI to store all its settings; otherwise, each power on would act as if the BIOS was just reset. These batteries typically last several years and rarely need to be replaced.

26. USB 3.2 Gen2 Header (Type-C)

The USB 3.2 Gen2 header is used to connect additional USB interface plugs to the motherboard; these headers are most often used to connect the motherboard to the chassis to enable the USB 3.2 Gen2 ports on the chassis. These will function similarly to the USB 3.2 Gen2 Type-C port sometimes

found on a motherboard's rear I/O hub, but can also be used for the chassis' front panel USB, auxiliary ports that mount in the card slots, and certain devices that directly connect to the header. The USB 3.2 Gen2 Header on the Z490 FTW is a shielded USB 3.2 Gen2 Header and supports up to 10Gb/s with USB 3.2 Gen2.

This USB 3.2 Gen2 Header has a power limit of 3000ma (3A) @ 5V.

27. USB 3.2 Gen1 Header

The USB 3.2 Gen1 header is used to connect additional USB interface plugs to the motherboard; these headers are most often used to connect the motherboard to the chassis to enable the USB 3.2 Gen1 ports on the chassis. These will function similarly to the USB 3.2 Gen1 ports found on the motherboard's rear I/O hub, but can also be used for the chassis' front panel USB, auxiliary ports that mount in the card slots, and certain devices that directly connect to the header.

USB 3.2 Gen1 standard is 900ma @ 5V for unpowered devices. If your USB device requires more power, it is recommended to attach a powered USB Hub.

USB 3.2 Gen2 Type-A (found on the I/O Hub) shares the power limit of USB 3.2 Gen1 at 900ma @ 5V.

Note: USB 3.2 Gen1 is more commonly referred to as USB 3.0.

28. BIOS SafeBoot Button

Pressing this button while the system is running will reboot the motherboard directly into the BIOS without clearing CMOS. This feature is very useful for situations where the motherboard is unable to complete boot due to a failed overclock and the user does not want to erase the previous settings used.

29. BIOS Selector Switch

This switch toggles between physical BIOS chips. This board has 2 BIOS chips as a permanent fixture. Each chip holds only the settings and profiles that have been saved to the BIOS chip while active. This allows you to swap between two physically different BIOS chips. This also makes it substantially easier to hotflash a BIOS if needed. If instructions are needed for hotflashing a BIOS, please contact EVGA Customer Service (Page 150 for contact info).

30. Rear Panel Connectors (Figure 2)

This is the section referred to as the I/O Hub. This panel contains the hardwired USB, Sound, and Ethernet connections. Please see Page 13 for a component level breakdown.

* There are two numeric references for PCI-Express: one is mechanical (the actual slot-length footprint across the motherboard), while the second is electrical (the number of PCIe lanes available to the slot from the CPU, PCH, or both).

PCI Express was designed with a universal architecture; you can install x1 cards, such as sound cards or USB controllers, into an x16 slot. Many types of cards can use various numbers of PCIe lanes; similarly, some applications might only use certain parts of a card (e.g. compute apps), requiring only a single PCIe lane to accomplish its task without affecting performance. This is why there are x16 mechanical slots with an x1 electrical PCIe lane. Using the entire length of a PCIe slot is unnecessary, nor does it cause an adverse effect to use a shorter form-factor bus card in a slot that physically can hold a larger form-factor bus card.

Card Slots

The Z490 FTW features two x16 PCIe slots, one x1 PCIe slots, two Socket 3 Key-M M.2 110mm, and one Socket 1 Key-E M.2.



PCIe Slot Breakdown

PCIe Lane Distribution (All Socket 1200 processors are 16 lanes.)

- ❑ PE1 – x16 (Gen3, x16 lanes from CPU, x8 shared with PE2)
- ❑ PE2 – x16 (Gen3, x8 lanes from CPU, shares 8 of PE1's 16 lanes)
- ❑ PE3 – x1 (Gen2, x1 lanes PCH)

M.2 Slot Breakdown

M.2 Lane Distribution

- ❑ M.2 Key-M (2) (110mm, Top) – x4
 - M.2 Enable/Disable is set within the BIOS
 - This slot supports both PCIe and SATA M.2 SSDs.
 - This slot supports Intel Optane.
- ❑ M.2 Key-M (1) (110mm, Bottom) – x4
 - M.2 Enable/Disable is set within the BIOS
 - This slot supports Intel Optane.
- ❑ M.2 Key-E (32mm) – x1
 - M.2 Enable/Disable is set within the BIOS

Installing the CPU

Note: EVGA strongly recommends that you completely disconnect AC power from your power supply prior to changing your CPU. This ensures the motherboard will use the correct startup procedure for all onboard devices. If AC power is not disconnected, the replacement is still supported, but may require additional reboots to boot successfully.

Be very careful when handling the CPU. Hold the processor only by the edges and do not touch the bottom of the processor.

Note: Use extreme caution when working with the CPU to avoid damaging the pins in the motherboard's CPU socket!

Do not remove the socket cover until you have installed the CPU. This installation guide was created without using a socket cover to better illustrate the CPU Socket area. However, users should remove the cover as the **last step**, not the first step.



Use the following procedure to install the CPU onto the motherboard.

1. Unhook the socket lever by pushing down and towards the socket.
2. Pull the socket levers back and gently lift the load plate to open the socket. Make sure to avoid touching or dropping items into the socket; otherwise, you may damage the board socket and/or CPU pins, which may void your warranty.

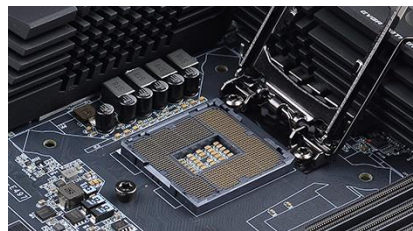
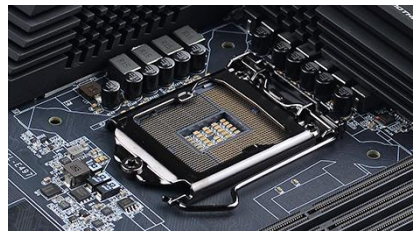

3. Align the notches on the CPU to the notches in the socket, and lower the processor straight down into the socket.

Note: The gold triangle key on the CPU should match the triangle key on the load plate.

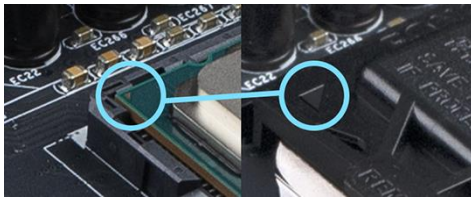

Note: Make sure the CPU is fully seated and level in the socket.

4. Lower the load plate so that it is resting on the CPU.
5. Carefully lock the lever back into place by lowering it down to the hook, then push the lever towards the socket and down under the hook.
6. Remove the plastic protective socket cover by pulling it straight up and away from the socket.



Note: After removing the CPU socket cover, it is recommended to store it in case you ever need to transport your motherboard. If you ever remove the CPU, it is highly recommended to reinstall the socket cover.

Installing the CPU Cooling Device

There are many different cooling devices that can be used with this motherboard. Follow the instructions that come with your cooling assembly.

Installing System Memory (DIMMs)

Your Z490 FTW has (4) 288-pin slots for DDR4 memory. These slots support 4GB, 8GB, 16GB and 32GB DDR4 DIMMs. There must be at least one memory slot populated for the board to boot and operate.

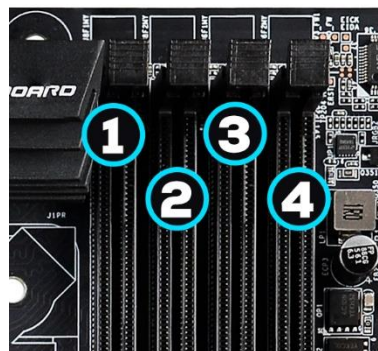

The Intel® Z490 chipset supports dual-channel DDR4 memory, a maximum of 128GB and up to 4400MHz+ (OC). You must first populate either the even-slots (2, 4) or odd-slots (1, 3). See chart below:

Use the following procedure to install memory DIMMs. Note that there is a small gap near the center of the DIMM slots. This matches the gap on a DDR4

| RAM slot fill order | | | | |
|---------------------|--------|--------|--------|--------|
| | Slot 1 | Slot 2 | Slot 3 | Slot 4 |
| 1 DIMM | | X | | |
| 2 DIMM | | X | | X |
| 3 DIMM | | X | X | X |
| 4 DIMM | X | X | X | X |

DIMM to ensure the memory is installed properly, and to prevent the incorrect installation of memory.

1. Unlock a DIMM slot by pressing the both module clips outward.
2. Align the memory module to the DIMM slot, and insert the module perpendicular to the DIMM slot, pressing straight down to seat the module. The plastic clips at top side of the DIMM slot automatically lock the DIMM into the connector.

Note: The memory controller on most Comet Lake-S CPUs runs at a default frequency of 2933MHz on 10- and 8-core processors, but only 2666MHz on 6-core processors. Achieving memory speeds above the CPU's default speed may require manual setting of the memory timings, frequency and voltages and/or overlocking of the CPU.

Refer to the memory manufacturer specifications for the recommended memory timings. For overlocking support you can visit our forums:

<https://forums.evga.com/>

Installing the I/O Shield

The motherboard kit comes with an I/O shield that is used to block internal components from dust and foreign objects, while also promoting correct airflow within the chassis.

Before installing the motherboard, install the I/O shield from the inside of the chassis. Press the I/O shield into place and make sure it fits securely.

Installing the Motherboard

Proper motherboard installation depends on several factors: whether the Z490 FTW will replace an older motherboard or the beginning of a new PC, the type of chassis that will house your PC components, and the amount of space you will have to build your system once the motherboard is installed. You must first determine if it would be easier to secure the motherboard to the chassis or if it would be easier to install other components prior to this step. It is normally easier to secure the motherboard first.

Note: Be sure that the CPU fan assembly has enough clearance for the system case covers to lock into place and for expansion cards. Also, make sure the CPU Fan assembly is aligned with the vents on the covers; this is to allow the airflow to properly exhaust from the chassis. The CPU Fan assembly orientation will depend on the system case being used.

Securing the Motherboard into a System Case

Most system cases require installation of standoffs into the chassis to allow the motherboard to be mounted to the chassis and prevent short circuits. If there are any studs that do not align with a motherboard mounting hole, we recommended that you remove that standoff to prevent the possibility of a short circuit. Furthermore, ensure that all standoffs are fully tightened prior to mounting the motherboard to the chassis. Please review the installation manual included with your chassis for the proper installation of the motherboard standoffs.

1. Carefully place the motherboard onto the standoffs located inside the chassis.
2. Align the mounting holes with the standoffs.
3. Align the connectors to the I/O shield and/or I/O cover.
4. Ensure that the fan assembly is aligned with the chassis vents according to the fan assembly instruction.
5. Secure the motherboard with ten (10) screws (See next page for mount hole location). Ensure that each screw is lined up with and fastened to its corresponding standoff under the board. Double-check alignment to make sure nothing gets cross-threaded.

Tip: If you have difficulty fastening some of the screws, especially near the I/O hub, first try to loosely fasten all other screws on the motherboard, but do not completely tighten the screws. This may help to hold the board in place, allowing you to thread and fasten the remaining screws. Once all screws are properly threaded, remember to go back and tighten the rest of the screws.

6. See the picture below for a zoomed-in view of a hole to place over a standoff, as well as the locations of standoff holes for the Z490 FTW.



1. All safe locations to secure the board to a standoff are circled in blue.
2. Keep in mind that when the screws are installed, but not fully tightened, the motherboard should have 1-2mm of movement. This movement can help when mounting cards or if you have tight-fits with other components.
3. Once the board is properly aligned, be sure to completely fasten the board to the chassis before proceeding.

Installing M.2 devices

Installing M.2 Key-M Socket 3 Devices

Securing an M.2 device to the motherboard requires a few extra steps compared to other current drive or slot-based connectors. M.2 devices used on this motherboard - Socket 3 (for SSDs) and Socket 1 (for WiFi/Bluetooth) – are installed differently.

Below are images from an installation of an SSD on a Socket 3 Key-M 110mm slot of the Z490 FTW.

1. Before you can install an M.2 device, you must first remove the screw that comes pre-attached to the Socket 3's retention standoff; this will be used to keep the device in place. The standoff is placed at the 80mm interval for the Socket 3 slot.



Next add one thermal pad – included with the Z490 FTW accessories – to the outlined area to the right.

2. After adding the thermal pad, the motherboard will look like the image below. This thermal pad will assist with cooling your M.2 Key-M device.

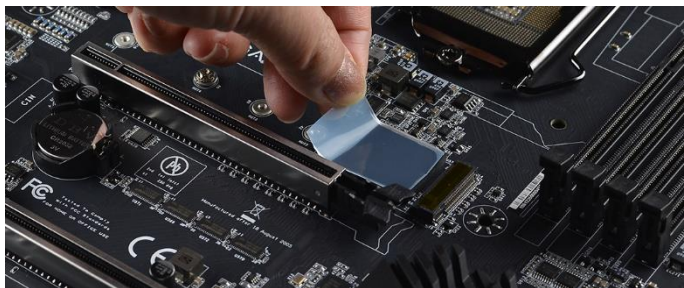

3. Insert the M.2 device at a slight angle of approximately 45 degrees to the board. This will allow the contacts (colloquially called “Gold Fingers”) to seat completely into the slot. If the device is fully seated, you should be able to release it and the device will rest at an angle of about 30 degrees on its own, as shown in the picture to the right.



4. Gently push the M.2 device down on the raised end. There will be some tension - this is normal - then use the screw you removed in Step 1 to secure the device. At right, you can see that the contacts will be nearly invisible when the device is properly seated and the copper mounting semi-circle is partially visible around the screw.

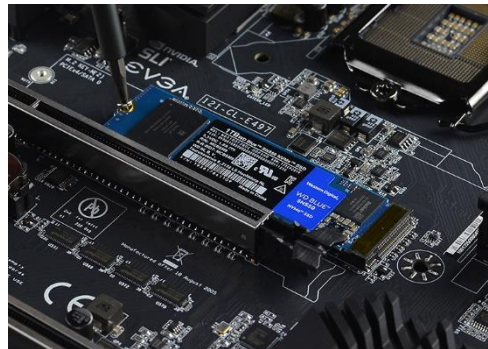

Incorrect installation Example:

***NOTE* This is one of the most common examples of an incorrect installation of an M.2 device. Do not intentionally attempt this, or complete your installation with this example. Doing so could cause damage to the device or the M.2 port.**

Using the image below, notice how the gold fingers fail to fully seat in the M.2 slot. This often occurs if the drive was pushed into the slot from a nearly parallel starting position, rather than an angle, causing the M.2 device to not seat fully. As a result, this may cause a drive detection failure by the BIOS, causing the drive to be detected with the description in gibberish (e.g. characters in the name, such as @, #, \$, %, *, etc.) and/or notifications that the drive has corrupt data stored on it.

Moreover, if the device’s connection looks like this, then screwing down the device may be impossible (a VERY tight fit, at best), which is another sign that the device is not seated properly.

In conclusion, if the install device looks similar to the image below, please remove and reseat it using the instructions above. **DO NOT POWER THE SYSTEM ON IF THE CONNECTOR RESEMBLES THIS PICTURE.**

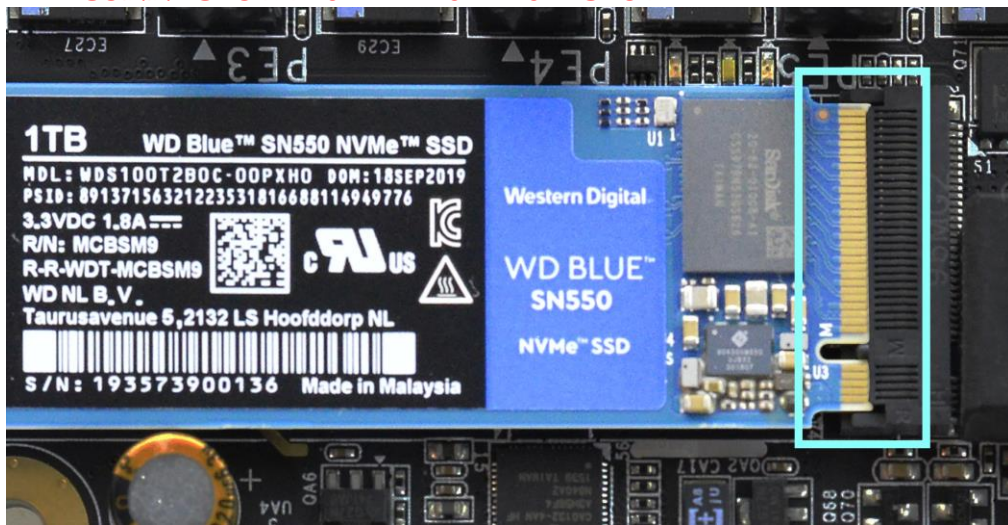

For further M.2 setup instructions please see Page 51.

Tested CPU

| CPU | Core Count | Frequency | PCI-E Lanes |
|------------------|---------------|-----------|-------------|
| Comet Lake-S | | | |
| Core™ i9 10900KF | 10 Cores +HT | 3.70 GHz | 16 |
| Core™ i9 10900K | 10 Cores + HT | 3.70 GHz | 16 |
| Core™ i9 10900F | 10 Cores + HT | 2.80 GHz | 16 |
| Core™ i9 10900 | 10 Cores +HT | 2.80 GHz | 16 |
| Core™ i7 10700KF | 8Cores + HT | 3.80 GHz | 16 |
| Core™ i7 10700K | 8Cores + HT | 3.80 GHz | 16 |
| Core™ i7 10700F | 8Cores + HT | 2.90 GHz | 16 |
| Core™ i7 10700 | 8Cores + HT | 2.90 GHz | 16 |
| Core™ i5 10600KF | 6 Cores + HT | 4.10 GHz | 16 |
| Core™ i5 10600K | 6 Cores + HT | 4.10 GHz | 16 |
| Core™ i5 10600 | 6 Cores + HT | 3.30 GHz | 16 |
| Core™ i5 10500 | 6 Cores + HT | 3.10 GHz | 16 |
| Core™ i5 10500T | 6 Cores + HT | 2.30 GHz | 16 |
| Core™ i5 10400F | 6 Cores + HT | 2.90 GHz | 16 |
| Core™ i5 10400 | 6 Cores + HT | 2.90 GHz | 16 |
| Core™ i5 10400T | 6 Cores + HT | 2.00 GHz | 16 |
| Core™ i3 10320 | 4 Cores + HT | 3.80 GHz | 16 |
| Core™ i3 10300 | 4 Cores + HT | 3.70 GHz | 16 |
| Core™ i3 10300T | 4 Cores + HT | 3.00 GHz | 16 |
| Core™ i3 10100 | 4 Cores + HT | 3.60 GHz | 16 |
| Core™ i3 10100T | 4 Cores + HT | 3.00 GHz | 16 |

Tested Memory

For a full list of tested CPUs and Memory, please visit

<https://www.evga.com/support/motherboard/> and select the EVGA Z490 FTW from the list.

Tested M.2 Key-M

| PCIE INTERFACE | |
|-----------------------|--|
| ADATA | ASX8000NP-256GM-C 256G M.2 PCIE |
| Samsung | MZ-VKV512 950 PRO |
| Samsung | MZ-V6P512 960 PRO |
| Samsung | MZ-VPV2560 256G SM951 NVME |
| Samsung | MZ-HPU128T/004 128G XP941 |
| Samsung | MZ-HPV1280 128G SM951 |
| Samsung | MZ-V6E250 250G 960EVO |
| Samsung | MZ-MZ-VPW2560 256G SM961 |
| Samsung | MZ-VLW2560 256G PM961 |
| Samsung | MZ-VLB2560 256G PM981 |
| INTEL | 600P SERIES SSDPEKKW512G7 M.2 512G PCIE |
| INTEL | 600P SERIES SSDPEKKW256G7 M.2 256G PCIE |
| INTEL | 760P SERIES SSDPEKKW010T8 M.2 1TB PCIE |
| Kingston | SKC1000240G |
| Kingston | SHPM2280P2H/240G |
| PLEXTOR | PX-128M8PeG M.2 128G PCIE |
| TOSHIBA | THNSN5256GPU7 M.2 256G PCIE |
| WD | PC SN520 SDAPNUW-512G-1006 512G NVME M2 |
| WD | PC SN700 WDS100T2X0C-00L350 1T NVME M2 |
| WD | PC SN750 WDS100T3X0C-00SJG0 1T NVME M2 |
| WD | Blue SN500 WDS500G1B0C-00S6U0 500G PCIE3.0 NVME M2 |
| WD | Blue SN550 WDS100T2B0C-00PXH0 1TB PCIE3.0 NVME M2 |
| CORSAIR | MP500 CSSD-F240GBMP500 240G PCIE3.0 NVME M2 |

| SATA INTERFACE | |
|-----------------------|---|
| INTEL | SSDSCKKW240H6 240G SATA6G |
| INTEL | SSDSCKHW120A4 120G SATA M2 device |
| INTEL | SSDSCKKW120H6 120G SATA6G |
| Transcend | TS128GMTS800 128G SATA M2 device |
| WD | WD WDS240G1G0B-00RC30 240G SATA 6G |
| WD | WD WDS250G2B0B-00YS70 250G M2 SATA 6G |
| WD | WD WDS500G2B0B-00YS70 500G M2 SATA 6G |
| WD | WD WDS200T2B0B-00YS70 2T M2 SATA 6G |
| Samsung | Samsung MZ-NLN1280 PM871 M2 128G SATA 6G |
| Samsung | Samsung MZ-N6E250 860 EVO M2 250G SATA 6G |
| KLEVV | KLEVV NEO N600 M2 240G SATA 6G |

Tested M.2 Key-E

| M.2 Key-E WIFI | |
|-----------------------|------------|
| INTEL | 8260NGW |
| INTEL | 9260NGW |
| INTEL | 9560NGW |
| INTEL | AX201NGW |
| AzureWave | AW-NB165NF |
| Killer | 1550 |
| Killer | 1550i |

Connecting Cables

Note: the following images do not necessarily represent the physical orientation of their respective headers on the EVGA Z490 FTW. Instead, these graphical representations are designed to provide a basic physical footprint and the cable pinouts for each component.

The locations of these components can be found in the Component Legend on Pages 11-13.

This section takes you through all the necessary connections on the motherboard. This will include:

- ❑ Power Connections
 - 24pin ATX power
 - EPS 8-pin 12V power
 - ATX 4-pin 12V power
- ❑ Internal Headers
 - Front Panel connectors (Power/Reset/LEDs)
 - PWM Fan Headers
 - ARGB LED Header
 - RGB LED Header
 - USB 3.2 Gen2 Header
 - USB 3.2 Gen1 Header
 - USB 2.0 Header
 - USB to SPI Header (for flashing BIOS)
 - Audio Header
 - SATA
- ❑ Rear I/O Panel

24pin ATX Power (ATX_PWR_24P)

24-pin Main Power

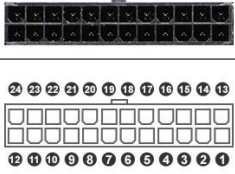

| | | | |
|---------|-----------|----------|---------|
| 1 +3.3V | 7 GND | 13 3.3V | 19 GND |
| 2 +3.3V | 8 PWROK | 14 -12V | 20 RSVD |
| 3 GND | 9 +5V_AUX | 15 GND | 21 +5V |
| 4 +5V | 10 +12V | 16 PS_ON | 22 +5V |
| 5 GND | 11 +12V | 17 GND | 23 +5V |
| 6 +5V | 12 +3.3V | 18 GND | 24 GND |

ATX_PWR_24p is the main power supply connector located along the lower-right edge of the board. Make sure that the power supply cable and pins are properly aligned with the connector on the motherboard. Firmly plug the power supply cable into the connector and make sure it is secure.

The 24-pin Power Connector may be standard or right-angled depending on your motherboard model.*

*The Z490 FTW motherboard uses a standard, vertical 24pin ATX connector.

EPS 8-pin 12V Power (PWR 8P)

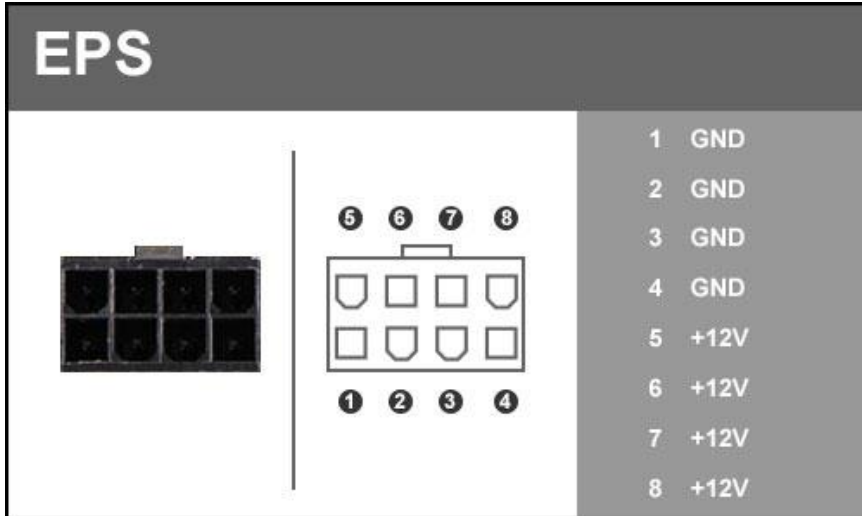

EPS PWR 8P, the 8-pin ATX 12V power connection(s), is used to provide power to the CPU. Align the pins to the connector and press firmly until seated. The secondary EPS, if present, is optional for improved overclocking. Please remember to make sure that the tab on the EPS socket is aligned with the release clip on the cable. **NOTE:** If the tab and release clip are on opposite sides, yet the power connector fits, then you are using a PCIe 8-pin cable, which **WILL** damage the board if powered on. Please review installation instructions from your power supply manufacturer to verify which connectors may be used for the CPU power.

ATX 4-Pin 12V Power (PWR 4P) (Optional)

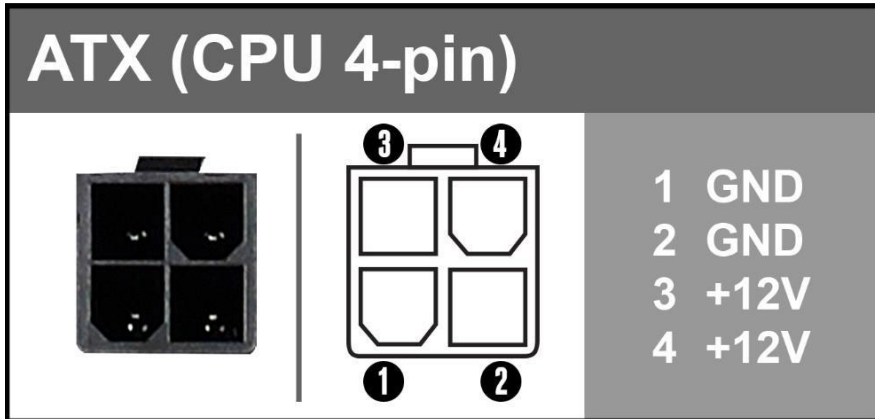

ATX PWR 4P (OPTIONAL), the 4-pin ATX 12V power connection(s), is used to provide additional power to the CPU. Some power supplies provide a dedicated 4-pin CPU ATX power connector, while other power supplies split an 8pin EPS connector into a 4+4 pin connector; either of these 4-pin power connector are proper connectors for this port.

This secondary power connector is optional to provide additional power for improved overclocking. Please remember to make sure that the tab on the ATX socket is aligned with the release clip on the cable. **NOTE:** If the tab and release clip are on opposite sides, powering on the system **WILL** damage the board. Please review installation instructions from your power supply manufacturer to verify which connectors may be used for the CPU power.

Front Panel Header

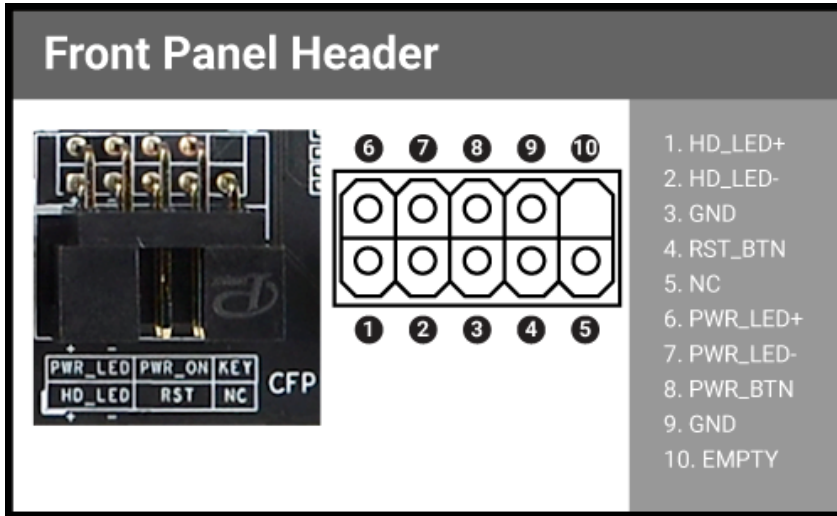

The front panel header on this motherboard is used to connect the following four cables:

- ❑ **PWRLED**

Attach the front panel power LED cable to these two pins of the connector. The Power LED indicates the system's status. When the system is powered on, the LED will be on.
- ❑ **PWRSW**

Attach the power button cable from the case to these two pins. Pressing the power button on the front panel turns the system on and off rather than using the onboard button.
- ❑ **HD_LED**

Attach the hard disk drive indicator LED cable to these two pins. The HDD indicator LED indicates the activity status of the hard disks.
- ❑ **RESET**

Attach the Reset switch cable from the front panel of the case to these two pins.

Note: Some system cases may not have all four cables. Be sure to match the name on the connectors to the corresponding pins.

Fan Header

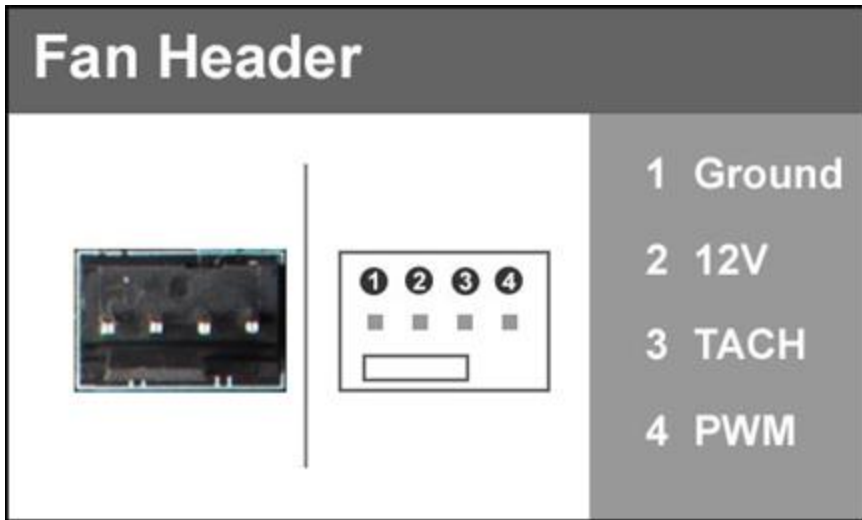

This motherboard line only has 4-pin fan headers, which are backwards compatible with 3-pin fan connectors. Fans may be controlled by PWM or DC controls. The headers have an absolute safe power limit of 2 Amp @ 12 Volts (24 Watts). These headers are for your CPU heatsink and chassis cooling fans.

ARGB Header

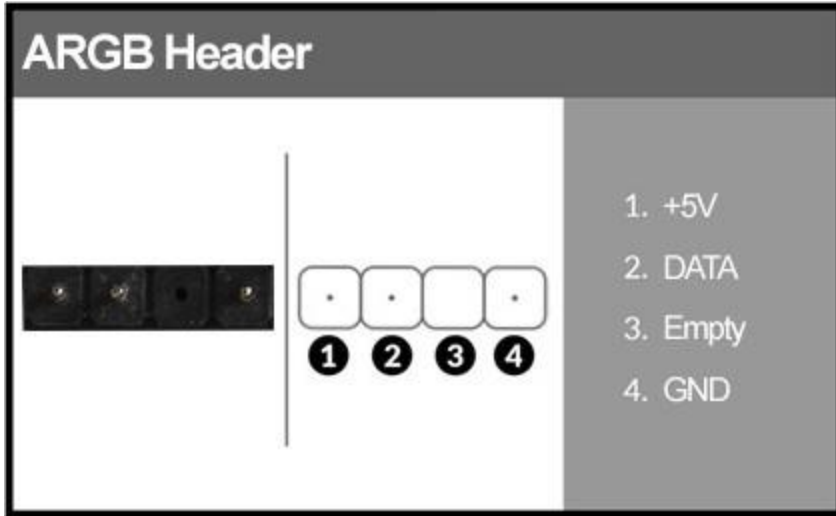

This header and pinout is used for increased control and options over addressable RGB LED strips or devices connected to this header, compared to a standard 12V RGB Header. This header supports up to a maximum of 2 Amps @ 5 Volts (10 Watts) or up to 125 LEDs. This will add control options through EVGA ELEET X1 for controlling RGB LEDs.

RGB Header

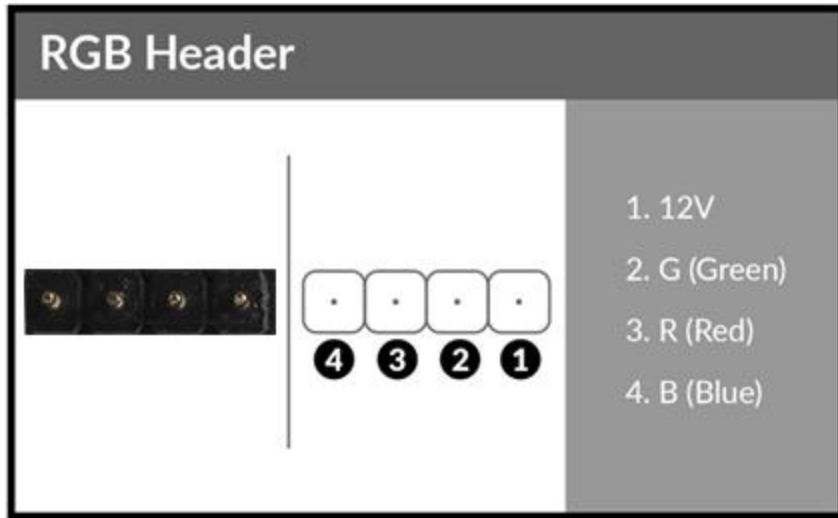

This header and pinout is also shared with the RGB LED header, which also supports up to 2 Amps @ 12 Volts (24 Watts). This will add control options through EVGA ELEET X1 for controlling RGB LED's.

USB Headers

This motherboard contains USB 3.2 Gen2 and 3.2 Gen1 ports that are exposed on the rear panel of the chassis.

The Z490 FTW contains 1x 20pin internal header, which can support 1 USB3.2 Gen2 Type-C front-panel connector or device.

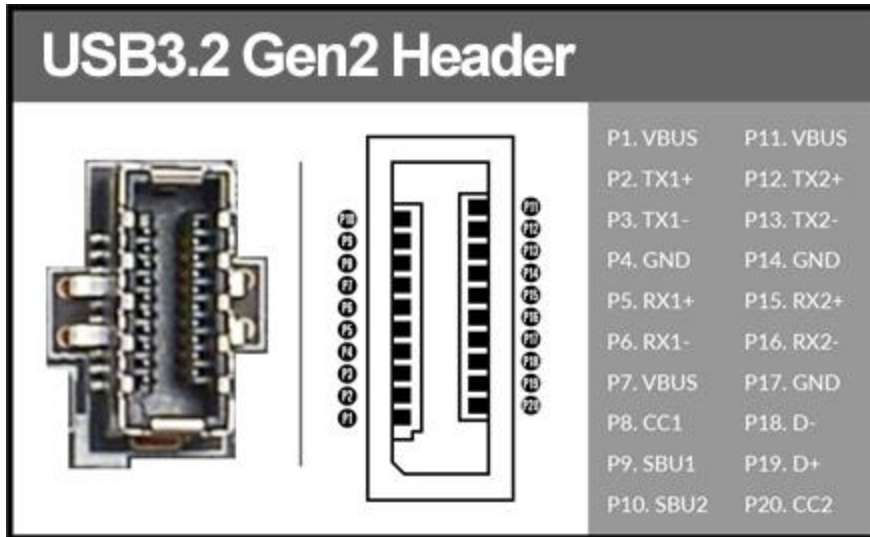

The motherboard also contains 1x 19-pin internal header connectors onboard that can be used to connect an optional external bracket or device containing up to two (2) USB 3.2 Gen1 ports.

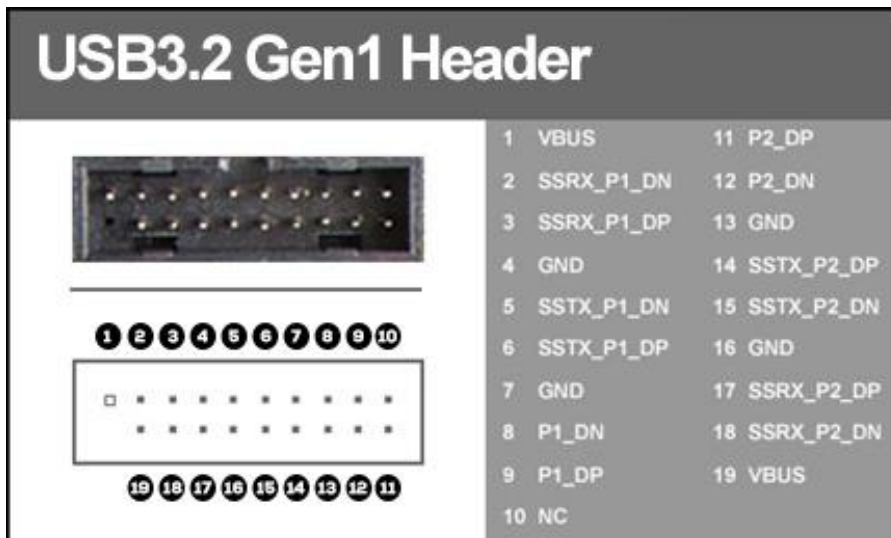

- Please note that these headers are often referred to as USB 3.0 internal headers, but the correct designation is USB 3.2 Gen1.

The motherboard contains 2x 9-pin internal header connectors onboard that can be used to connect an optional external bracket or devices containing up to four (4) USB 2.0 ports.

USB 2.0 Header

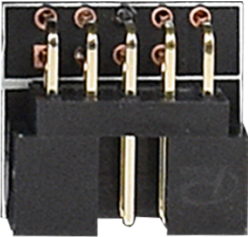

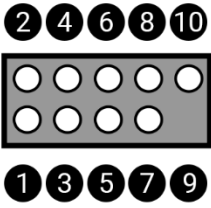



| Pin | Signal |
|-----|------------|
| 1 | 5V_Dual |
| 3 | D- |
| 5 | D+ |
| 7 | GND |
| 9 | Empty |
| 2 | 5V_Dual |
| 4 | D- |
| 6 | D+ |
| 8 | GND |
| 10 | No Connect |

The Z490 FTW also features an onboard USB 2.0 port header, near the power/reset buttons. This header has a specific purpose – to allow you to flash the BIOS without an installed CPU using the included USB flash drive. For more information on flashing the BIOS without a CPU, please see Page 144.

USB to SPI BIOS Flash





| | |
|----|--------|
| 1. | VCC |
| 2. | DATA - |
| 3. | DATA + |
| 4. | GND |

Front Panel Audio Header

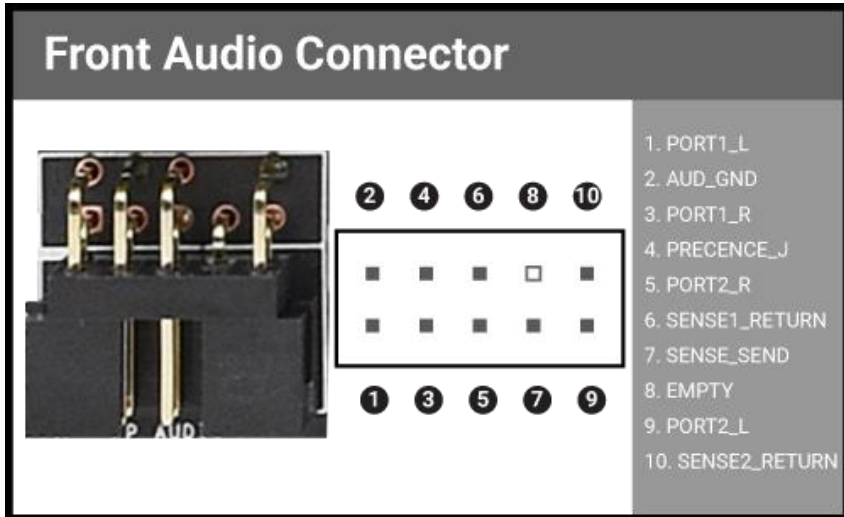

Front panel audio supports HD Audio for stereo/gaming headphones or 2.1 speakers, and a Mic.

The EVGA Z490 FTW front panel audio connector supports the use of EVGA NU Audio when headphones or a headset are connected.

Drive Headers (SATA)

SATA3/6G is the current standard for HDD/SSD/Optical interface. These cables are the data interconnect for the motherboard. Your HDD/SSD/Optical interface will still require a separate power connection from your power supply.

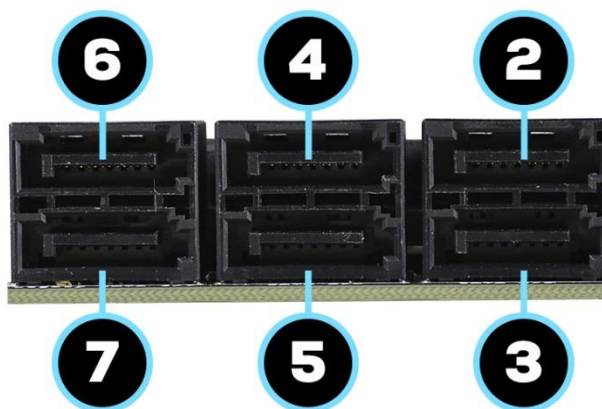

Intel® SATA ports on the platform natively support full AHCI and RAID functions. AHCI is enabled by default, but the controller can be put into RAID mode in the BIOS. RAID is supported for levels 0, 1, 5, and 10 through the Intel® controller (Ports 2, 3, 4, 5), and all ports retain full AHCI functionality in RAID mode.

RAID is ***not*** supported on the ASMedia 1061 controller (Ports 6, 7).

See Page 54 for RAID levels supported and explanations for how they work.

Onboard Buttons

These onboard buttons include RESET, POWER and Clear CMOS. These functions allow you to easily turn on/off the system, reset the system, or clear the CMOS.

Clear CMOS Button

The motherboard uses CMOS RAM to store set parameters. Clear the CMOS by pressing the button shown on the right.

This button has two main uses:

The first is to clear BIOS and power on before updating the BIOS, and the second is to troubleshoot instances when the motherboard fails to POST (e.g. after upgrading RAM or CPU, installing new hardware, a failed overclock, etc.).

This button provides a much faster means of resetting CMOS than removing the CMOS battery, and discharging power to the board.



↑
External Clear CMOS Button

RESET and POWER Button

These onboard buttons allow you to easily power on/off or restart the system. These buttons allow for easy debugging and testing of the system during troubleshooting situations.



↑ ↑
Reset Power
Button Button

First Boot

BIOS Update

When you power on the system for the first time (or after a BIOS update/reset) it may take a little longer than expected, and follow with a warning message on the screen reading “BIOS checksum error”. This is completely normal.

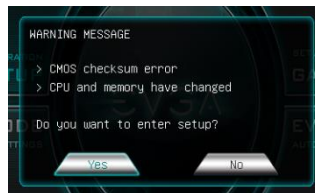

Depending on when the motherboard was purchased, compared to when it was released, there may be a BIOS update for it. If you have internet access on another PC and a USB Thumb Drive, it is highly recommended to download the current BIOS and flash the newer BIOS before attempting anything else.

If there is an updated BIOS, download and extract it onto a thumb drive formatted for FAT32, go to the EXTRAS section, select “BIOS Update,” and to navigate to where your ROM file is stored. Press Enter to update.

****IMPORTANT NOTE. DO NOT CUT POWER OR REBOOT THE SYSTEM DURING A BIOS UPDATE; YOU WILL LIKELY RENDER THE ACTIVE BIOS UNBOOTABLE****



Once the BIOS is updated, you will be greeted with the same screen as before stating that there is a Checksum error. Please press “Delete” to go into the BIOS/UEFI.

The Z490 chipset is designed for UEFI mode and Windows 10 natively. However, Legacy mode is included if your older hardware is not compatible with UEFI. In most cases, there is very little setup needed on these boards.

Memory Setup

To setup the Memory, use the arrow keys or your mouse to select the “Memory” setting. Select the “Memory Profiles” pulldown and select XMP Profile 1. This will automatically set some basic memory information, such as speed, latency and voltage. You may set the memory speed manually, if you’d prefer, but the XMP will generally get the memory running at the memory manufacturer’s specification with little to no effort.

HDD/SSD/M.2 Setup

Next, click “Boot” from the menu list at the top. “Boot Option #1” should show the device that you intend to install your operating system.

If you are using a standard SSD/HDD connected to a SATA port, but the device is not present in the Boot Option #1 menu, scroll down to “UEFI Hard Disk Drive BBS Priorities” at the bottom. In this menu, the top item will be “1st Boot” and will have a pulldown menu on the right. Click on the pulldown menu and select the intended drive; this will make the drive appear on the previous menu. If the drive continues to be missing, please check the troubleshooting section on Page 146.

If you plan on using an M.2 as a boot device, click on or navigate to the “Advanced” menu, select “Onboard Device Configuration” and enable the port with your installed M.2 device.

Once this is done, press F10 to save and exit, plug in your operating system installation medium (likely a thumb drive) and Windows 10 should be able to boot to the M.2 without issue.

Additional information to assist with M.2 or PCIe installation can be found in the next section.

Note Some device manufacturers require specific drivers for HDDs or SSDs (such as M.2) before Windows can detect the drive for installation. Please make sure to consult the manufacturer’s instructions for your HDD or SSD before attempting to install Windows to determine if additional drivers are needed.

M.2 SSD, PCIe SSD, and NVMe SSD Installation steps

M.2 is a very fast card bus that can use multiple connector types to connect many types of devices, such as WiFi or SSDs, in a very small and power efficient package. M.2 devices can be connected via an M.2 card slot or through PCIe by using an M.2 to PCIe adapter. There are also PCIe native drives of this nature, such as the Intel® 750. NVMe stands for Non-Volatile Memory Express, and is a high-performance standard for M.2/PCIe SSDs. Most NVMe drives require device drivers during the Operating System installation to be recognized as a boot drive for M.2 and PCIe varieties.

M.2/PCIe share resources with other components on the motherboard, which may limit some hardware combinations. **PLEASE SEE CHART ON PAGE 23 FOR A DETAILED BREAKDOWN OF SHARED RESOURCES.**

M.2 Physical Installation

1. Please see Page 30 for M.2 physical installation instructions.

PCIe Physical Installation

1. Install the SSD into any available PCIe slot with at least x4 Lanes available (Gen3 Lanes are preferred for better speed, but Gen2 Lanes will still outperform the top end of SATA SSDs).
 - a. Please refer to Page 23 under PCIe Lane Breakdown for lane specifics, as the PCIe slot must be at least x4 electrically.
2. Attach the SSD's mounting bracket to the back of the case.
3. Native PCIe drives will not normally require a separate power or data cable attached; all power and data transfers are done through the PCIe slot.

BIOS Setup and Windows Installation for M.2 and PCIe NVMe SSDs

1. Remember, NVMe is a new standard and older operating systems do not have native support. Many NVMe drives require certain steps to make the drive bootable, even with current operating systems.
PLEASE FULLY READ THE INSTRUCTIONS THAT COME WITH YOUR M.2 or PCIe NVMe SSD BEFORE INSTALLATION.
2. After reviewing your SSD's instructions and its respective Physical installation instructions above, power on the PC and enter the BIOS/UEFI by pressing the F2 key repeatedly.
3. Once in BIOS/UEFI, navigate to the "BOOT" section. Then go down to the "CSM Configuration" heading and press enter, or click on it with your mouse.

- a. For Windows 10: Set “Launch Storage OpROM Policy” to “UEFI”. Then set “Launch CSM” to “Disable”.
4. Press F10 to save and exit the BIOS/UEFI.
5. Press Del on reboot to reenter BIOS/UEFI.
 - a. If you are using a SSD-attached via PCIe, proceed to Step 6.
 - b. If you are using the motherboard’s M.2 slot, proceed to Step 8.
6. If you are using an SSD connected via PCIe (e.g. an Intel® 750) or through an adapter that connects an M.2 SSD to PCIe, go to “Advanced – PCIe Configuration” and verify that the device shows on the slot you have it installed.
 - a. Verify the lane count and PCIe Generation. It should state “x4 Gen3”.
7. Next check the Dashboard on the upper right. The populated slot, lanes used, and PCIe Generation should all match the information found in the previous step.
 - a. Proceed to Step 9 when done.
8. If you are using an SSD connected to the motherboard’s M.2 slot, re-enter the BIOS/UEFI and go to “Advanced – Onboard Device Configuration,” and set “M.2 Socket3” to “Enable.” The EVGA Z490 FTW auto-enables this option if an M.2 SSD is detected. However, it is still worth checking to make sure the option is enabled and/or the device is detected.
9. Go to the “Boot” Section, set “Boot Mode Select” to UEFI, and set first boot device to “Hard Disk:Windows Boot Manager”.
10. Press F10 to save and exit. Insert/Connect your Operating System install media and reboot.
11. Begin the Windows installation. During the drive selection step, you may need to load additional drivers that are provided by the SSD’s manufacturer, which would be covered in the SSD manual. If these steps are not followed you will likely be unable to install the Operating System to the SSD and make it bootable.

Internal RAID Controller

This section introduces RAID, RAID levels, and the basics of the controller integrated into the PCH. It covers the basics of what RAID does, how RAID works, and why you may or may not want to use RAID.

This section is GREATLY simplified; those who have experience with RAID - especially from the server side - will find this a VERY rudimentary simplification of a process that is quite complex on the back-end. The descriptions of the RAID levels are not based on the back-end logic from the controllers, but rather just a breakdown as a visual reference to understand the basics.

For the sake of explanation in this section, every drive representation here is assumed to be 1 Terabyte (for ease of math); also the reference of P-Drive is “Physical” drive, and L-Drive is referencing “Logical” drives; physical drives are the physical drive you installed, whereas the logical drive is what Windows sees in Disk Management. This is a necessary distinction because RAID is a form of drive virtualization; taking several physical drives and making one logical drive out of them. You can add a minimum of two drives up to a maximum of six drives depending on the configuration (for this controller specifically) and the operating system will see only one logical device.

RAID LEVELS

ALL RAID LEVELS: All RAID levels will lose some capacity through the process of making the array. A small amount of disk space is used, in part, to maintain connections to data across drives, but the quality and size of drives used can impact the amount.

A general rule of thumb for final array capacity is this: Take the number of drives, the array type, and individual drive capacity (for this RAID breakdown all drives are 1TB) and multiply it out as shown below for the specific RAID type you intend to use:

RAID0 = (Number of Drives) * (Drive capacity)

RAID1 = Capacity of one drive, as all data is copied on both drives

RAID5 = (Number of drives – one drive) * (Drive capacity)

RAID10 = (Half the number of drives) * (Drive capacity)

To account for capacity lost both due to maintaining the array as well as what is lost during the formatting process, multiply the product by .85 and you should see a volume close to this number once the array is partitioned. This will vary based on type of drive,

its quality, and many other factors; but the number should give you a ballpark estimate on what to expect as a final capacity once formatted.

Please see below for examples of what to expect when you build an array of each type. Each RAID type will use diagrams to illustrate functional and non-functional forms of each RAID; all green items indicate a drive that is functional, and red indicates a drive that has failed.

BEFORE BUILDING AN ARRAY, CONFIRM THAT YOUR SSDs OR HDDs ARE THE SAME MAKE, MODEL, AND CAPACITY. MIXING DRIVES CAN RESULT IN ODD PERFORMANCE ISSUES, ARRAYS DE-SYNCING, LARGE SCALE DATA CORRUPTION, AND/OR UNRECOVERABLE ARRAY FAILURE.

MAKE SURE THAT YOUR INTENDED HDD SUPPORTS RAID; IF NOT, THE DRIVE MAY CAUSE CONSTANT DESYNCRONIZATION ISSUES DUE TO DATA TTL TIMERS NOT SENDING AN “ALL IS WELL” SIGNAL WITHIN THE EXPECTED TIMEFRAME, WHICH WILL SEND THE CONTROLLER THE MESSAGE THAT THE DRIVE HAS FAILED OR DISCONNECTED.

If you are unsure about any of the bolded section above, please contact the drive manufacturer’s customer service to make sure the device is supported for RAID. If the drive is not, the controller cannot work around it and make it function as intended.

RAID0: This type of array is often referred to as “Striping” or a “Striped Array.” RAID0 takes a data set and spreads it equally across two (2) or more drives. The logic behind this array is that reading a single file, for example, will be much faster if the file is spread across two (2) or more drives and read from both drives simultaneously; thus reducing the time each drive spends in the read process by at least 50% rather than being read from one source. The file is then reassembled once the data hits RAM. This is similar, in theory, to how multi-channel memory or SLI works: load balancing for storage.

Because RAID0 is only designed to distribute the data being written across multiple devices to improve performance there is ****NO FAULT TOLERANCE****, meaning if one drive fails, the array fails. It MAY be possible to recover the data but that usually requires a data recovery service, which is not guaranteed and is usually very expensive.

RAID0 is typically only limited by the controller; however, you will get severely diminishing performance returns after 4 drives. If you go above 4 drives, you will also see more capacity loss after creating the array.

The Good-

- it can greatly increase the read/write speed of drives
- The most storage capacity-friendly use of drive space compared to other array types.

The Bad

- RAID0 has no redundancy, which makes it very volatile, if you lose even 1 drive, you lose everything.
- If you use this method, make sure to back up often.

Below is the breakdown of RAID0's function and the breakdown of a drive failure in this type of array. Wherever you see the section labelled "DATA" at the bottom turn **red**, this indicates an array failure.

RAID 0 (2 Drive)

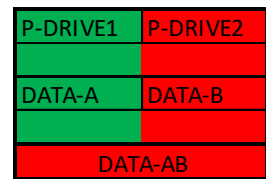
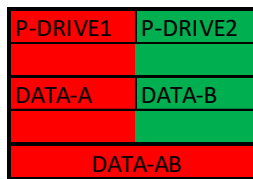
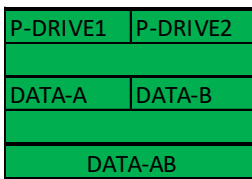

L-DRIVE = ≈ 2TB

As RAID0 has no fault tolerance, even a single drive failure compromises the array and renders the array Failed and unrecoverable.

The array depictions below show how this issue scales to larger arrays. In fact, due to the lack of fault tolerance, the potential failure rate actually increases because of the addition of more drives that can physically fail.

RAID 0 (4 Drive)

| | | | |
|-----------|----------|----------|----------|
| P-DRIVE1 | P-DRIVE2 | P-DRIVE3 | P-DRIVE4 |
| | | | |
| DATA-A | DATA-B | DATA-C | DATA-D |
| | | | |
| DATA-ABCD | | | |

| | | | |
|-----------|----------|----------|----------|
| P-DRIVE1 | P-DRIVE2 | P-DRIVE3 | P-DRIVE4 |
| | | | |
| DATA-A | DATA-B | DATA-C | DATA-D |
| | | | |
| DATA-ABCD | | | |

| | | | |
|-----------|----------|----------|----------|
| P-DRIVE1 | P-DRIVE2 | P-DRIVE3 | P-DRIVE4 |
| | | | |
| DATA-A | DATA-B | DATA-C | DATA-D |
| | | | |
| DATA-ABCD | | | |

| | | | |
|-----------|----------|----------|----------|
| P-DRIVE1 | P-DRIVE2 | P-DRIVE3 | P-DRIVE4 |
| | | | |
| DATA-A | DATA-B | DATA-C | DATA-D |
| | | | |
| DATA-ABCD | | | |

| | | | |
|-----------|----------|----------|----------|
| P-DRIVE1 | P-DRIVE2 | P-DRIVE3 | P-DRIVE4 |
| | | | |
| DATA-A | DATA-B | DATA-C | DATA-D |
| | | | |
| DATA-ABCD | | | |

L-DRIVE = ≈ 4TB

RAID1: This type of array is referred to as “Mirroring” or a “Mirrored Array.”

RAID1 uses two (2) physical drives and writes ALL data to both drives simultaneously providing a 1 to 1 mirror, giving you a live 100% redundancy. If a drive fails while data is being written, you will still be up and running. In most cases, when a failure occurs, you will experience a stutter in performance and a small but noticeable slow down.

Next, you’ll likely see a popup warning from IRST alerting you that a drive has failed or is disconnected, and your array’s status has been changed to “Degraded”.

RAID1 (at least on these PCH driven controllers) are limited to 2 drives. Because this is a mirror, you will use 50% of your capacity in redundancy.

The Good-

- RAID1 allows you to suffer a catastrophic failure of 1 drive with no ill effects to the data being stored.
- Because data is stored on 2 drives at once, read speeds typically increase a little, but not to the speed of RAID5 and, certainly, not to the speed of RAID 0.

The Bad-

- RAID1 is not a storage capacity-friendly array, because the capacity will be limited to 1 drive.
 - Due to the capacity available on modern drive solutions, this issue may not be as significant as it once was.
- Write speed will be a bit lower than a single drive.

In the charts below, you can see the effect of fault tolerance when using a mirror array: because all data has a direct 1-to-1 duplicate on the mirrored drive, you can suffer a catastrophic failure of a drive and still retain your data.

For a RAID1 array to lose its data, both drives must fail.

RAID 1 (2 Drive)

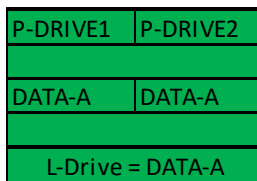

L-DRIVE = ≈ 1TB

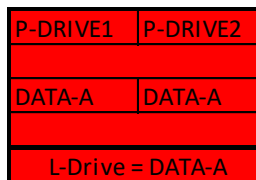
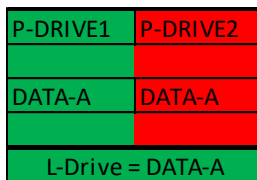
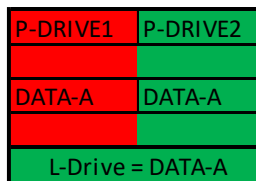

RAID5: RAID5 is a stripe with Fault Tolerance, which attempts to bridge the gap between speed and redundancy. This level will always reserve a capacity equivalent to one drive for fault tolerance, regardless of the overall capacity. This means that if you

use four 1TB drives to create your RAID5, you will only have the capacity of three 1TB drives; likewise, if you use five 1TB drives to create your array, you will only have the capacity of four 1TB drives. RAID5 requires a minimum of three drives, and the maximum is set by the RAID controller; this level works well when using between four to six drives, but sees diminishing returns beyond six.

Similar to RAID1, or any other current type of array with fault tolerance, a RAID5 array is still usable even while it is experiencing a missing or failed drive resulting in the array functioning in a degraded state. Performance will suffer in a degraded state until the missing drive is replaced and the software rebuild process is completed. During the rebuild process, performance will be severely degraded and can take several hours, depending on the size of the array and percentage of capacity used.

The Good-

- Most space efficient array-type that also has fault tolerance.
- Initial array builds quickly
- Read/write speed is very good; faster than RAID1 but slower than RAID0

The Bad-

- Rebuilding an array can take a long time on an integrated PCH controller, especially when using a very large array with multiple drives or capacity.
 - For this reason, RAID5 is sometimes more beneficial on a dedicated RAID controller.
- If more than one drive fails at once (not likely, but still possible) you will suffer a total loss of data; the array will behave like a RAID0 losing a drive.
- RAID5 is close to outliving its usefulness because it was created, in part, to create large size arrays with fault tolerance. Due to the capacity available on modern drives, other RAID solutions are now better and with fewer downsides.

RAID5 protects data rotating parity (there are several terms coined by different RAID manufacturers over the years for RAID5 and they all mean roughly the same thing), which means taking small portions of data, duplicating them and putting them onto different drives. When a drive that has failed is replaced, its data is recreated by the remaining drives in the array, which will require a very high volume of small data segments copied back over to the replacement drive while also maintaining the array's index of data. Once the rebuild is complete, current data can be read from the new drive and new data can be written to it.

The RAID5 diagram below is a bit more complicated than the others, due to the nature of how data is distributed. In the diagram you will see that there is one more Physical

drive than there is data set. This method of data distribution shows that as long as you have three (3) copies of each data set (Data-A, Data-B, and DATA-C), the array will be functional and capable of rebuilding when you add in replacement drive in. And while this is not mathematically correct for HOW the data distribution works, it is a good visualization to understand the basics of how it works.

RAID 5 (4 Drive)

| P-DRIVE1 | P-DRIVE2 | P-DRIVE3 | P-DRIVE4 |
|--------------------|----------|----------|----------|
| DATA-A | DATA-B | DATA-C | DATA-A |
| DATA-B | DATA-C | DATA-A | DATA-B |
| DATA-C | DATA-A | DATA-B | DATA-C |
| L-Drive = DATA-ABC | | | |

| P-DRIVE1 | P-DRIVE2 | P-DRIVE3 | P-DRIVE4 |
|--------------------|----------|----------|----------|
| DATA-A | DATA-B | DATA-C | DATA-A |
| DATA-B | DATA-C | DATA-A | DATA-B |
| DATA-C | DATA-A | DATA-B | DATA-C |
| L-Drive = DATA-ABC | | | |

L-DRIVE = ≈ 3TB

| P-DRIVE1 | P-DRIVE2 | P-DRIVE3 | P-DRIVE4 |
|--------------------|----------|----------|----------|
| DATA-A | DATA-B | DATA-C | DATA-A |
| DATA-B | DATA-C | DATA-A | DATA-B |
| DATA-C | DATA-A | DATA-B | DATA-C |
| L-Drive = DATA-ABC | | | |

| P-DRIVE1 | P-DRIVE2 | P-DRIVE3 | P-DRIVE4 |
|--------------------|----------|----------|----------|
| DATA-A | DATA-B | DATA-C | DATA-A |
| DATA-B | DATA-C | DATA-A | DATA-B |
| DATA-C | DATA-A | DATA-B | DATA-C |
| L-Drive = DATA-ABC | | | |

| P-DRIVE1 | P-DRIVE2 | P-DRIVE3 | P-DRIVE4 |
|--------------------|----------|----------|----------|
| DATA-A | DATA-B | DATA-C | DATA-A |
| DATA-B | DATA-C | DATA-A | DATA-B |
| DATA-C | DATA-A | DATA-B | DATA-C |
| L-Drive = DATA-ABC | | | |

| P-DRIVE1 | P-DRIVE2 | P-DRIVE3 | P-DRIVE4 |
|--------------------|----------|----------|----------|
| DATA-A | DATA-B | DATA-C | DATA-A |
| DATA-B | DATA-C | DATA-A | DATA-B |
| DATA-C | DATA-A | DATA-B | DATA-C |
| L-Drive = DATA-ABC | | | |

RAID10: RAID10 is the only level of nested RAID currently supported by the integrated PCH controller. Nested RAID is the process where a controller makes multiple RAID arrays, treating each of them as their own device and applies them to ANOTHER RAID level. This type of virtualization allows you to have an array where each node has its own level of redundancy.

In the instance of RAID10, it is two (2) or more Mirrored arrays (RAID1s) that are striped together (RAID0). In effect, this is RAID0 where every physical drive (now logical drive due to nested RAID functions) in the array is internally redundant via a mirror. This means you can lose a drive and the data set is still present; when the drive is replaced, it is replicated by the data internal to that node.

RAID10 is highly scalable. RAID10 always scales in two (2) drive increments, starting with a minimum of four (4) drives. This motherboard series supports a four (4) drive RAID10 array, with no option for scalability. Lastly, RAID10 is a mirrored array, which means it shares the same 50% drive capacity, since all data has a 1:1 copy.

The Good-

- Excellent Fault Tolerance
- Good rebuild times

- Vastly superior rebuild times compared to the previous 0+1 methodology of nested RAID.
- Overall performance is good; comparable or slightly faster than RAID5.

The Bad-

- Low space efficiency.
 - With the capacity of modern drives, this will likely be less of a consideration than in previous years.

The fault tolerance works a bit differently in RAID10 than in others because the array has nodes with internal redundancy. In other words, although a four drive array can lose two drives and remain operational, it greatly depends on WHICH two drives fail. If both drives from the same node fail, then half of the data is gone and the array has failed. However, every node, regardless of the number of total nodes, can suffer one internal failure with no adverse effects.



While the Z490 FTW Intel® controller will support a four drive RAID10 array, RAID10 can scale indefinitely provided the controller supports more drives. Every pair of drives adds an additional mirrored node, which increases the theoretical number of failures the array can suffer before a loss of data occurs. However, an array can still fail due to both drives on a node failing.

In the case of a drive failure, the array controller will notify you. When you replace a failed drive in the RAID10, rebuilding the array is mostly seamless.

For example, look at the array on the second row to the right. P-Drive1 failed, but P-Drive2 is still working and uses the same data. The array will pull data from P-Drive2 during the rebuild, so the array can be used normally while P-Drive2 copies ALL of its data back to the drive replacing P-Drive1.

The rebuild process will only rebuild 1TB worth of data because only one node failed. There will be a performance hit during the rebuild process, which can be further delayed if VERY data intensive applications are used, but overall performance of the array will still be fast enough to run effectively during the rebuild. RAID10 rebuilds much more quickly than its predecessor RAID0+1.

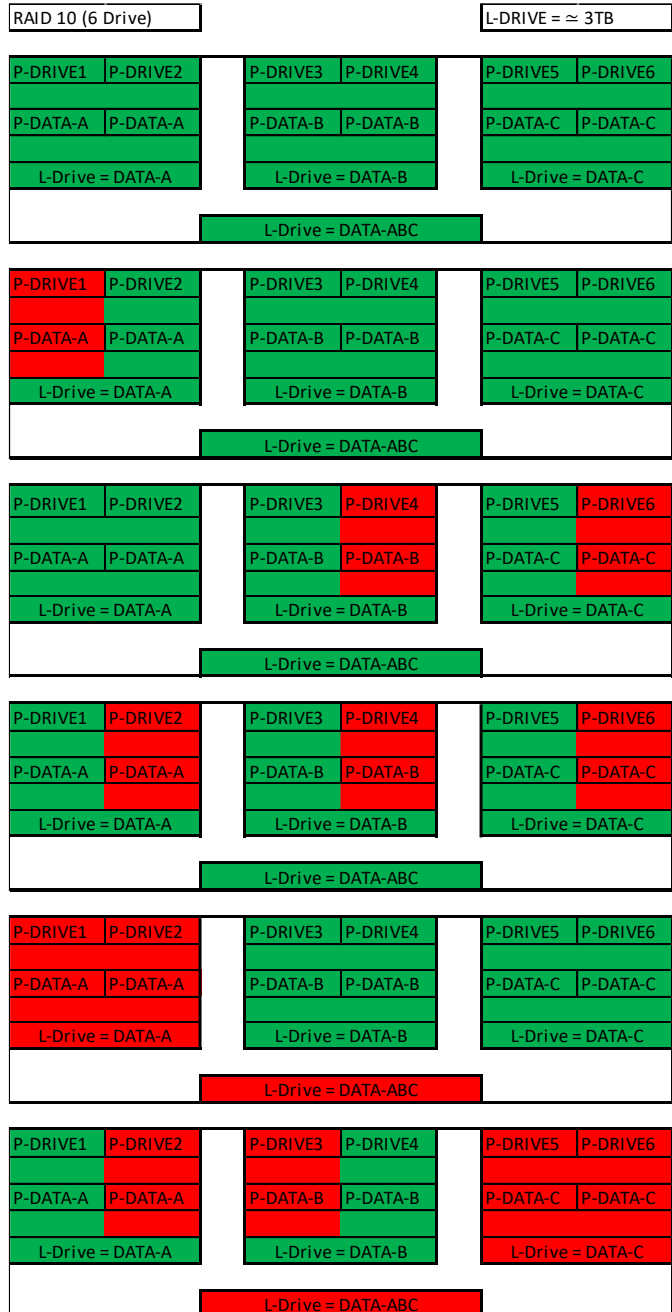

RAID0+1: RAID0+1 is a form of nested RAID that was widely used on previous generation boards. Although EVGA Z490 series motherboards do not use this type of array, it is listed here to show the improvements made by RAID10, and to clear up a common misperception that RAID0+1 and RAID10 are the same.

A RAID0+1 array is created from two (2) stripe sets that are mirrored together. Similar to RAID10, RAID 0+1 requires a minimum of four drives, and is highly scalable in two drive increments. Again, because RAID0+1 is a mirrored array, it shares the same 50% drive capacity, meaning that four 1TB drives in RAID0+1 will result in a 2TB array.

Where 0+1 differs from 10 is in how the drives are split, and the data distributed. While RAID10 is created using two or more mirror sets striped together, RAID0+1 is two striped sets mirrored together. When scaling with additional drives (in multiples of two), RAID10 adds the drives as another mirrored set to the striped array, whereas RAID0+1 splits the drives between the two stripes to maintain the mirror. To the end-user, the final result appears very similar; however, the significant differences lie in fault tolerance and recovery.

In a RAID0+1, ANY drive failure results in half of the array becoming effectively failed. If one drive fails, that stripe fails, and the mirrored stripe takes over. When the failed drive is replaced, the entire capacity of the mirrored array must be rewritten to the failed array, rather than one drive's worth of capacity (i.e. RAID10). This makes the RAID0+1 array more volatile than RAID10, despite being fault tolerant, and can also increase rebuild times at an exponential margin for large arrays.

Like RAID10, RAID0+1 can afford to lose up to half the number of drives in the array and still be protected; however, this is contingent on the failed units being all from the same stripe set. If one drive fails from both stripe sets at once, the entire array is lost.

The Good-

- Fastest of the standard nested RAID types
- Performance scales with drive count.

The Bad-

- Build times can be substantially longer than RAID10 due to the volume of data being moved, and is typically close to the rebuild times of RAID5.
- Low space efficiency, only 50% of total drive capacity is usable in the array.
- 1 drive failure drops a full stripe set.

RAID 0+1 (4 Drive)

L-DRIVE = ≈ 2TB

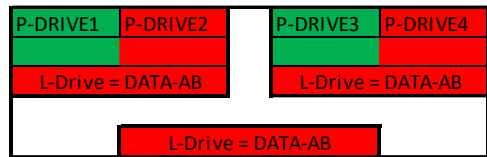
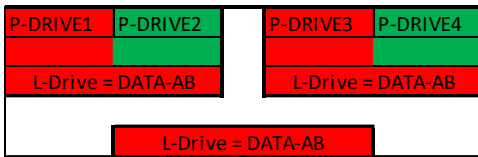
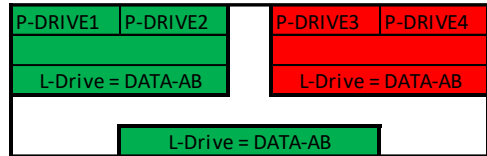
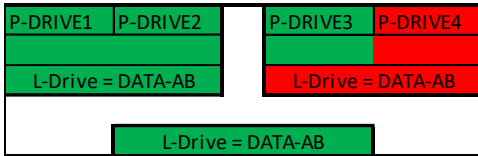
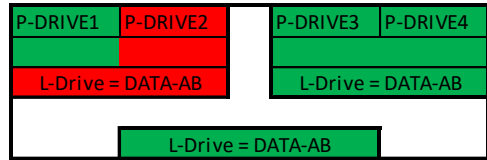
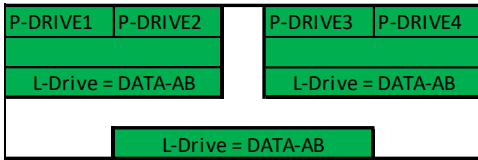

Motherboard controllers that support RAID0+1 (such as certain older generation EVGA motherboards) will generally support 4 or 6 drive arrays of this type; other controllers can allow this array type to scale indefinitely. Each pair of drives adds to the drive count for the stripes and increases the theoretical volume of failures the array can suffer before a loss of data occurs. However, this type of array can fail due to any two drives on different stripes failing at once; this is RAID0+1's main drawback. Theoretically, at six drives and above, RAID0+1 should have slightly faster read/write speeds compared to RAID10 because the stripes are larger without the overhead of an internal mirror. This is because RAID10 increases both the number of mirror sets as the array scales upwards and the backend calculations needed to maintain the arrays, whereas RAID0+1 only increases stripe size.

As you can see, the difference between RAID0+1 and RAID10 is significant when looking at how data is stored. Although the drive volume scaling and the level of fault tolerance is the same, internalizing the redundancy can make a significant difference overall to the array.

In the examples to the right, you can see that when one drive fails the entire stripe set fails; for a RAID0+1, you would need to rewrite 3TB worth of data back onto the failed node when rebuilding, rather than 1TB for the same drive count on a RAID10.

RAID10 is the current standard on Intel® PCH based RAID controllers, largely because the fault tolerance for it is a bit more forgiving and the rebuild speed is overall significantly faster than its RAID0+1 predecessor.



Which types of RAID can I use with my setup?

- 1 Drive – No RAID arrays are supported
- 2 Drives – RAID0 for speed (do regular backups) or RAID1 for data protection.
- 3 Drives – RAID0 for speed (do regular backups) or RAID5 for speed and protection.
- 4 Drives – RAID0 for speed (do regular backups), RAID5 for speed and protection, RAID10 for the best balance of Speed and protection.

Also, you can run more than one array on the Intel® controller, so long as the total is no more than four (4) drives. Because the Z490 FTW splits the SATA ports between 2 controllers, 5 and 6 drive arrays are not possible on this motherboard.

Configuring the Array

Please note that this section was configured with an earlier version of the EVGA GUI BIOS. The current GUI BIOS may look different, but will follow a similar set of steps to create and repair a RAID volume.

Attach all SATA devices you intend to use, and make sure power is attached. Power the system on. Press the “Delete” key repeatedly to enter BIOS. Once into BIOS you will need to enable the RAID function of the board.

Once into BIOS, click on (or navigate with your arrow keys) the “Advanced” tab at the top, and then on “SATA Configuration.”



In the “SATA Mode Selection” at the top, the default will be AHCI. Click on the arrow to the right side of AHCI or navigate to it with your keyboard and press “Enter” to open the pulldown menu. Select RAID from the list.

RAID mode not only includes the RAID controls, but also shares the same options/functions/commands as AHCI; you may continue using your AHCI devices normally when the SATA Configuration is set to RAID mode.

The SATA Information menu shows a list of all drives currently detected by the controller; make sure the list in your BIOS matches what you have plugged in. If it does not, reseal cables on the device(s) in question. If the issue persists, please check the troubleshooting section on Page 146.



Once RAID is enabled and all devices are detected, press F10 to save and exit. Upon reboot, repeatedly press “Delete” to reenter the BIOS. Once in the BIOS, go back to the “Advanced” tab where you’ll find a new item at the bottom of the list called “Intel® Rapid Storage Technology.”

The Intel® Rapid Storage Technology utility in the BIOS replaces the Intel® RAID manager that was previously launched outside of the BIOS in previous generation motherboards. Due to the current bootup process, speed of processors, and UEFI the previous method made accessing the Intel® RAID manager nearly impossible. This is the same controller that was previously accessed by CTRL-I; now, it is fully accessible within the BIOS/UEFI.



Once in the RAID controller, you will see a list of all detected drives and a “Create RAID Volume” button. To begin, click on “Create RAID Volume” or navigate to the button and hit “Enter.”



Choose a name for the volume. The controller allows up to 15 characters; you can use numbers and letters, but not special characters.

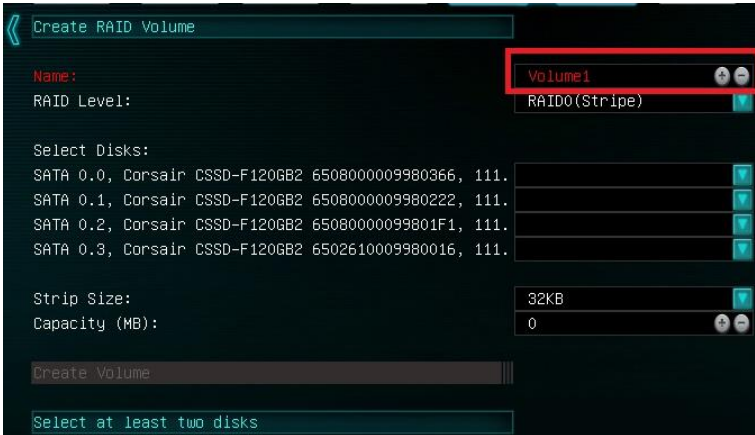

Next, select your intended array type. This can be done by either clicking on the down arrow and clicking on the RAID level you want, or pressing the enter key and using the down arrow to select the RAID level and pressing Enter again. Please see the top half of Page 67 for a quick reference on different RAID levels and RAID types based on your total number of drives.

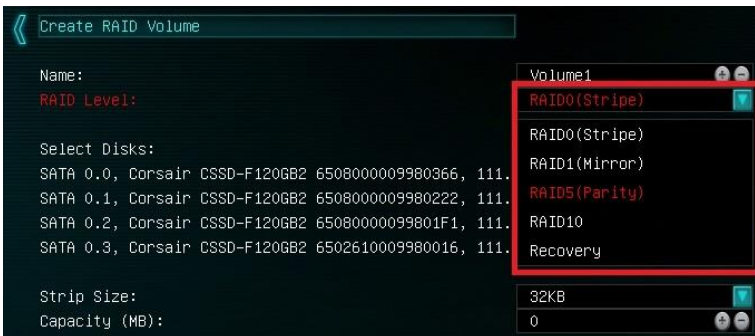

Next, select the drives you want to use for the array. Select the down arrow and the “X” for each drive you want to include in the array.

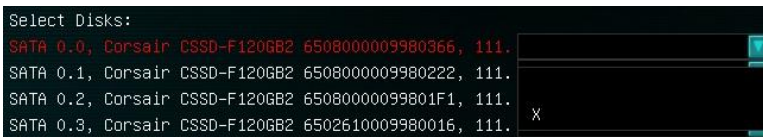

Strip size (also called “block size” in other controllers) can be selected manually at 16k, 32k, 64k, or 128k. The controller will determine the default strip size after looking at your drives and array type. Although there are some limited instances where this must be set manually, it is highly recommended to leave this at default.

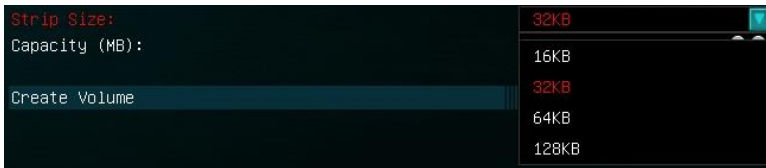

The controller defaults the capacity to the maximum available space for the RAID. Leaving the capacity at default is recommended because reducing the size is not beneficial, except in limited cases.

To complete the setup process, please select “Create Volume” at the bottom of the page. Depending on the array type, drive type, and volume this can take a few seconds to a few minutes.



Once the array is completed you will see the text shown on the next page, or something similar based on the array type and drives used. At this point, the array is ready to use.



If your array will be your boot drive, the operating system will normally detect the array and see it as a single drive (this is expected), it *MAY* detect it as a RAID array; either way, the OS installation will show the size of the array, not a single drive, and allow you to install the OS to the array without any further steps. However, depending on the OS version, you may need to install RAID drivers for the RAID array to be detected.

If this is meant to be a secondary array, your next step is to partition and format the array within Windows. Please see Page 85 for setup in Windows 10.

Repairing an array within UEFI

This guide will show you how to repair a degraded array from within the UEFI. For testing purposes, a drive was intentionally removed from a RAID5 array and wiped to guarantee that the array rebuild behaved the same as if a new replacement drive was added to a degraded array.

If a drive fails and the array becomes degraded, you will typically see an alert in Windows, during the controller booting (Legacy mode only), or while checking the array status within UEFI. If a drive fails in an array with redundancy (a RAID5 array, in this case), the controller will report the array as “Degraded” (see pic below). This means that the array has a node down, the data is still intact, but your fault tolerance is reduced.



Highlight the degraded array with your mouse or navigate to it with your keyboard and select it to bring you into the array screen (see image on next page), which will show you your array status and any drives that are not currently configured in a RAID array. The Non-RAID Physical Disks list will display any remaining drives on the controller, whether it is a random storage drive, a boot drive, or a replacement drive installed to replace a failed unit. For this example, you will see a degraded array and a “Non-RAID Physical Disk,” which we’ve attached to repair the degraded array.

The drive attached is an exact match to the other drives in our RAID 5; however, you can use a different drive if it is the same size and preferably same type/series, as well.

****ALL DATA ON THAT DRIVE WILL BE REMOVED AND WILL NOT BE RECOVERABLE WHEN ADDING IT INTO THE ARRAY****

The controller will also give you this information, but it cannot be overstated that using a drive with data on it will result in the total loss of all previous data in favor of the data on the array.



Select the degraded RAID volume, then select “Rebuild” on the following menu.

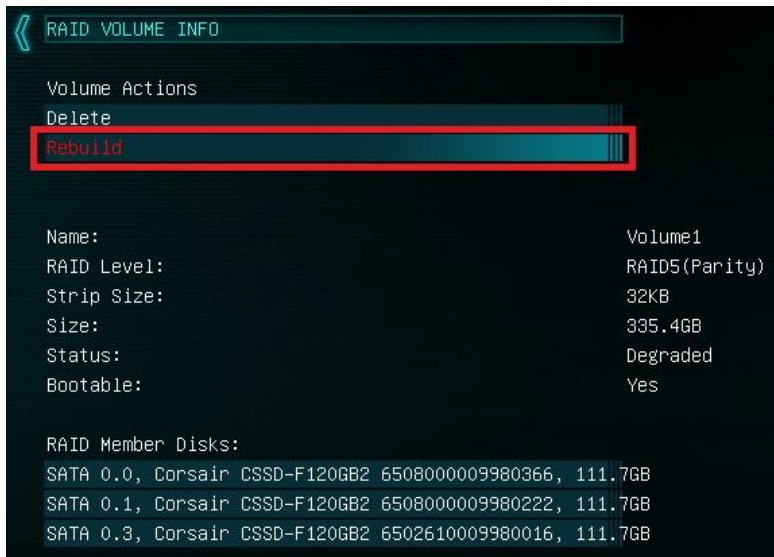

Next, you will see a list of all attached HDD/SSDs that can be used to rebuild the array. Select the disk, then click on it or press enter.

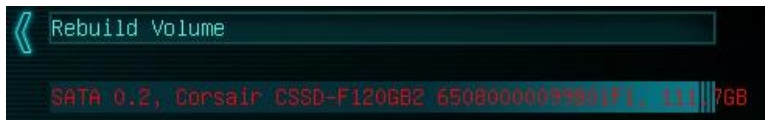

Once the process has started you will see the status change to “Rebuilding.”

A screenshot of a command prompt window showing the Intel(R) RST 14.6.0.2285 RAID Driver interface. The text "RAID Volumes:" is displayed, followed by "Volume1, RAID5(Parity), 335.4GB, Rebuilding" in red text on a dark background.

****Important Notice**:** The controller will not begin the rebuilding process until you have booted back into Windows; this queues the rebuild but does not start the process. The rebuilding duration will vary. Fast drives in uncomplicated arrays with small amounts of data can rebuild very quickly. Large platter drive-based arrays, especially in RAID5, can take several hours to rebuild. The duration of the rebuild process will further increase based on the usage of both the array and the CPU during the process. The rebuild process can be monitored from the “Intel® Rapid Storage Technology” utility in Windows, which is effectively the software front-end for the Intel® SATA controller. The rebuild status can be viewed in the “Manage” tab, located on the top of the IRST Window. Please see the image at the top of Page 84 to see an example of where to find the rebuilding % in the IRST.

IRST (Intel® Rapid Storage Technology)

The IRST is the software front-end for the Intel® SATA controller. It is recommended to install the IRST drivers after installing the Intel® Chipset Drivers – the main motherboard drivers. This guide walks you through not only the building, but also the repairing of an array from within Windows, since it may be more convenient to build new arrays within the OS rather than from within the UEFI. All forms of RAID that can be built in the UEFI are available in IRST; the IRST may be more convenient for some people due to a more detailed UI than the UEFI.

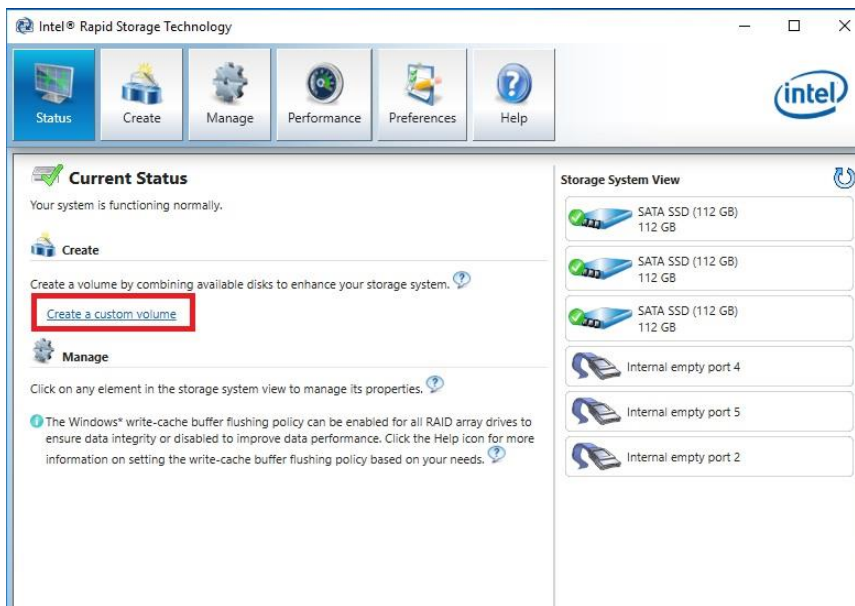

This guide will illustrate how to create a RAID1 array using the IRST. Using the screen above, we know that three (3) SSDs are currently attached to the controller and the other three (3) INTEL® SATA ports are empty (this can vary board to board based on how many Intel® SATA ports are present). If you plan to create another type of array, please ensure that you have the correct number of drives attached and shown on the status screen in IRST for your intended array before you start.

Referring to the above image, again, locate and click the hyperlink halfway down the window that says “Create a Custom Volume.” An array creation window will open:

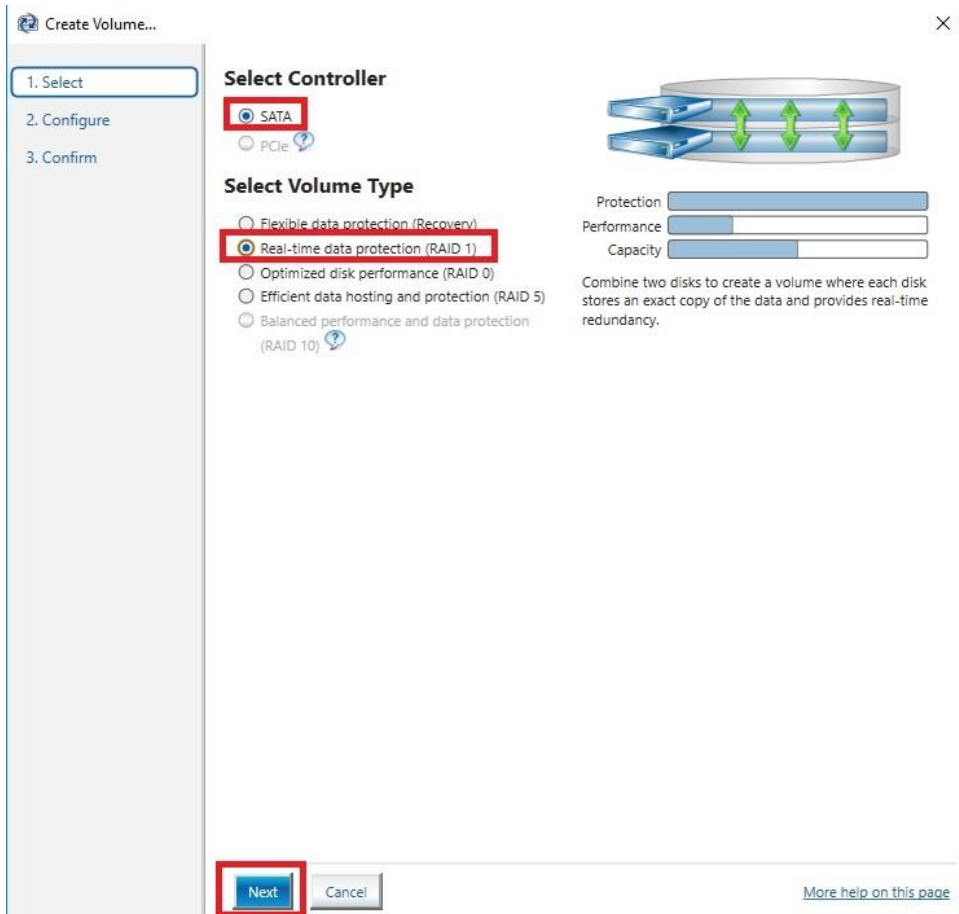

SATA will be selected by default. PCIe primarily refers to PCIe / M.2 based NVMe drives; the same basic steps do apply to both, however. Select SATA, and “Real-time protection (RAID1).” Then, click Next at the bottom of the window.

RAID1 can only support two (2) drives. Left-click the open boxes from the list below to select your two preferred drives. You may also name the array anything you like. Although you have the option to define volume size, it is recommended to leave the array at 100%, which is the default.

Create Volume... X

1. Select
2. Configure
3. Confirm

Configure Volume

Name:

Select the array disks (minimum selection required):

- ATA SSD on Controller 0, Port 0 (112 GB)
- ATA SSD on Controller 0, Port 1 (112 GB)
- SATA SSD on Controller 0, Port 3 (112 GB)

Volume Size | **Advanced**

Volume Size 114,473 MB

Array allocation: 100%

Proposed Configuration

Array_0000

Volume_0000
Type: RAID 1
112 GB

Back **Next** Cancel [More help on this page](#)

In the Advanced tab, you can select the option to “Initialize Volume,” which will occur after the array is created. If the array is not initialized now, it can be initialized later in “Disk Management.” See Page 85 for Disk Management instructions.

When done, click “Next” at the bottom.

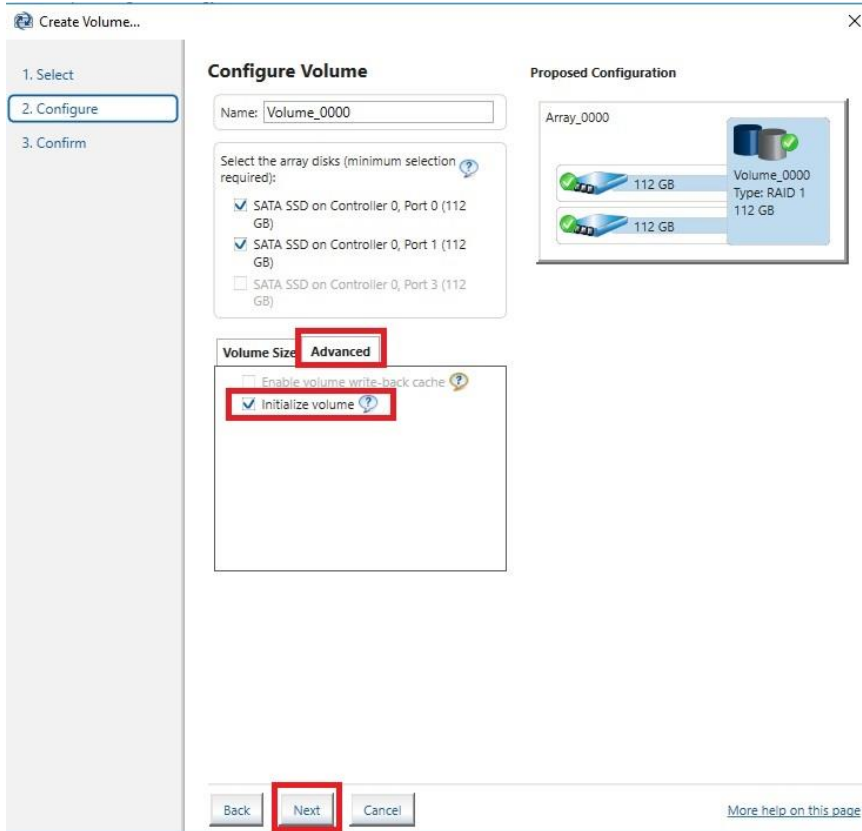

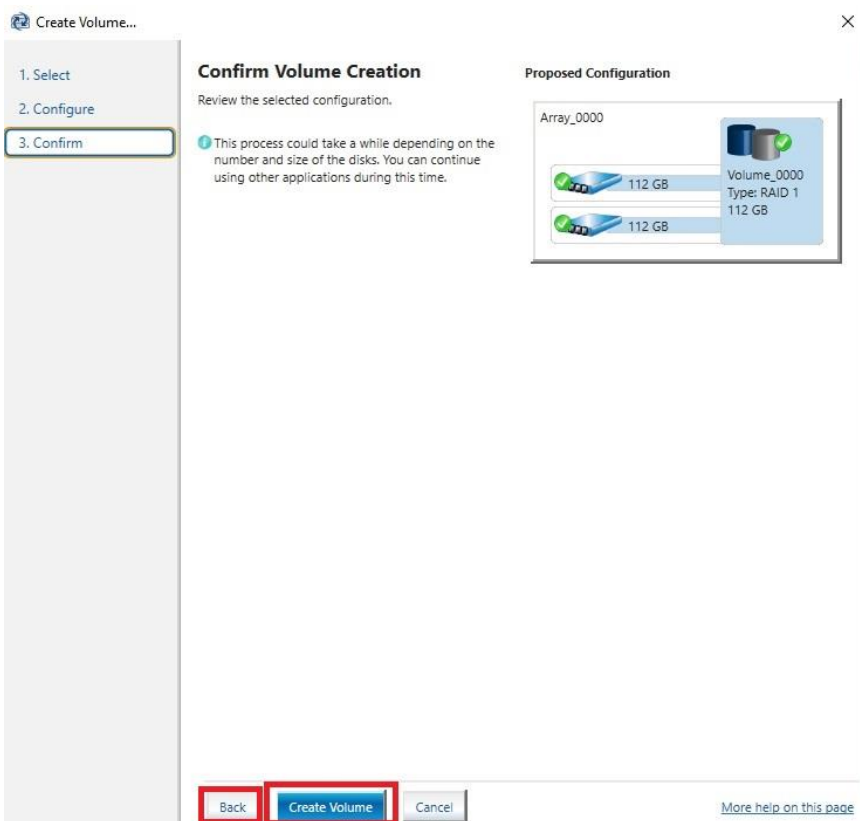

Review the summary provided on the confirmation screen. If you are unsure about any selections made, click the “Back” key and make your corrections. When ready, click “Create Volume” at the bottom. This typically takes between a few seconds to a couple minutes depending on the size and complexity of the volume. Once finished, you will see the message below. The array is now ready to be partitioned, formatted, and used.



Once you click the OK button on the RAID creation window you will be brought back to the main window, “Status” tab. If the option to initialize was selected, the initialization status will be shown below, circled in red.



If you select the “Manage” tab, you can see a bit more in-depth information on the array and additional options to manage or change the array.

Before the drive can be used, however, the drive must be partitioned, formatted, and assigned a drive letter. Please see Page 85 for instructions.



Repairing an array within IRST

This section of the guide will illustrate how to repair a degraded array from within the IRST. For purposes of this guide, we are repairing a degraded RAID 1 array using a third drive plugged into the controller, but not currently in use.

Below, you can see a degraded array, and one of its drives reported as missing/failed. The data on the other drive is still intact, but the fault tolerance is offline due to the missing/failed drive. The IRST also shows several warnings, the "!" for "Status," a "!" for the portion of the array missing (showing the degradation of the logical drive), and the "!" for the physical drive, which also states 0GB – a further indicator of a faulty drive. You can repair the array from here or from the Manage tab at the top of IRST.



The screenshot displays the Intel Rapid Storage Technology (IRST) application window. The interface is divided into several sections:

- Navigation Bar:** Includes tabs for Status, Manage, Performance, Preferences, and Help, along with the Intel logo.
- Current Status:**
 - Warning icon and title: **Current Status**
 - Message: "Your system is reporting one or more events, and data may be at risk. Refer to the details below for more information."
 - Manage:** A section with a gear icon and a help icon, containing a tip about Windows write-cache buffer flushing policy.
 - SATA_Array_0000:**
 - Volume_0000: **Degraded** (with a warning icon) and a button **Rebuild to another disk**.
 - Details: "Fix any problems reported on the array disks, or rebuild the volume to a new disk."
 - Unknown disk on Controller 0, Port Unknown: **Missing** (with a warning icon).
 - SATA SSD on Controller 0, Port 2: **Offline** (with a warning icon) and a **Clear metadata** button.
- Storage System View:**
 - Overview: SATA_Array_0000, Volume_0000 (Type: RAID 1, 112 GB).
 - Physical Drives:
 - 112 GB (Healthy)
 - 0 GB (Warning icon)
 - SATA SSD (112 GB) (Warning icon)
 - SATA SSD (112 GB) (Healthy)
 - Internal empty ports: 0, 4, and 5.

The “Manage” tab shows the array specifically, and not just the controller as a whole.

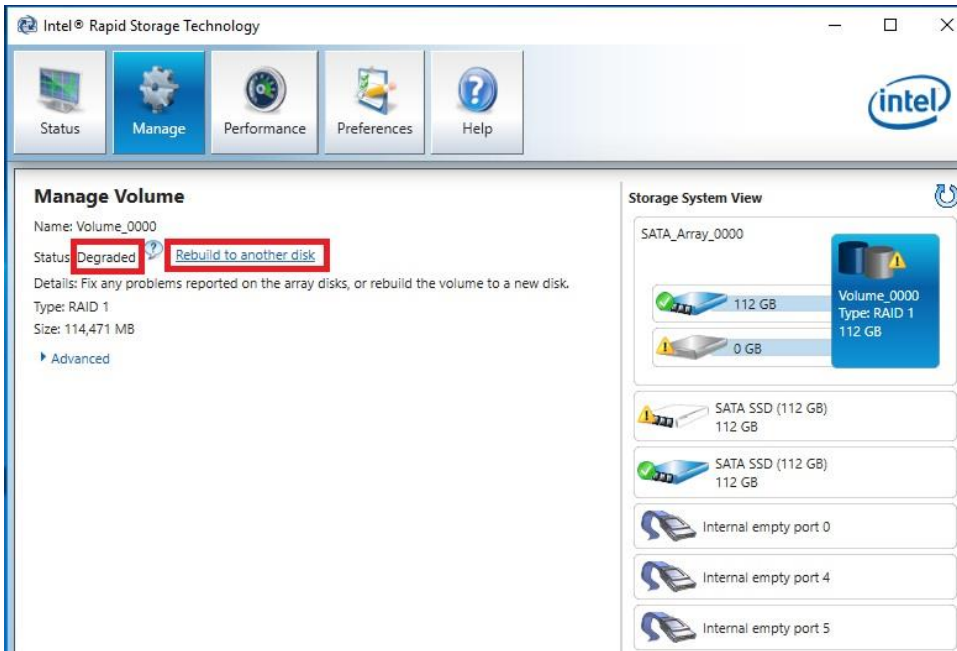

Next to “Status: Degraded,” left-click the hyperlink labeled “Rebuild to another disk.” This will bring a pop-up window over the IRST showing a list of attached drives that can be used for the repair (see pic on next page):

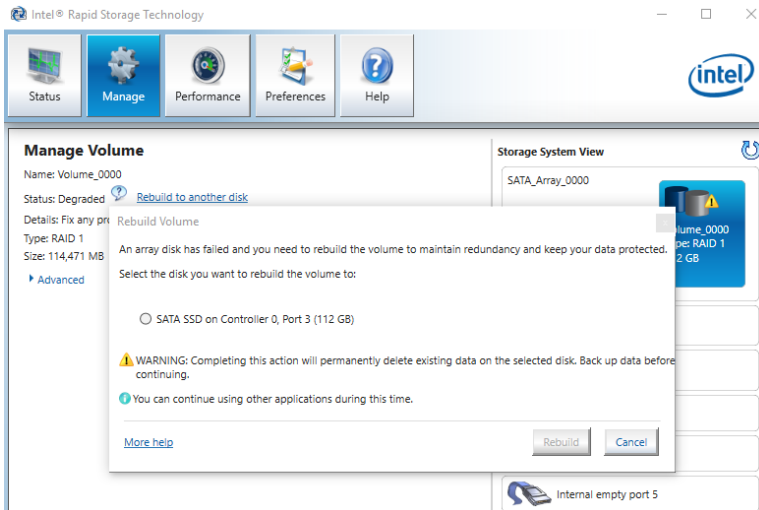

Select the drive you wish to use for the repair and click the “Rebuild” button.

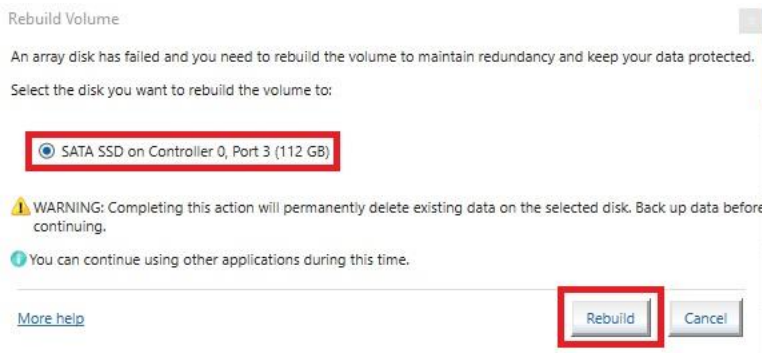

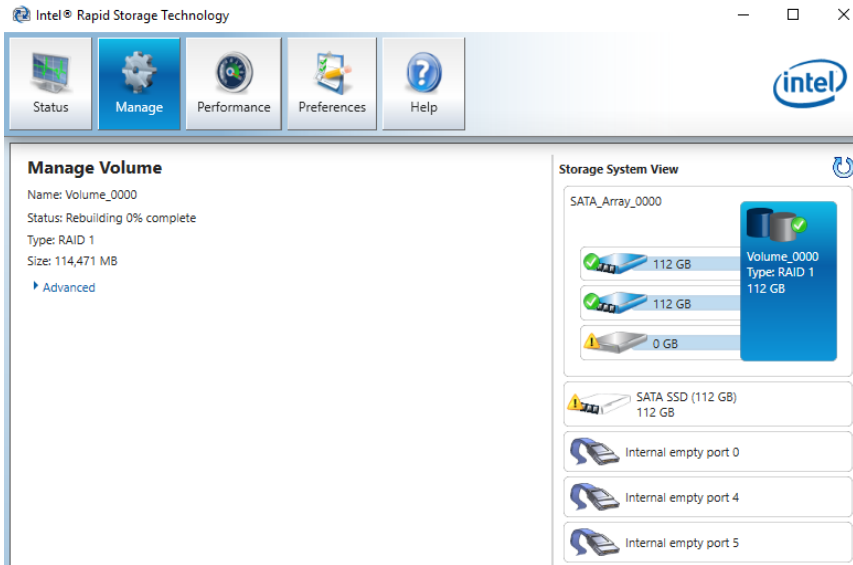

The rebuild process will begin. As with any RAID array with Fault Tolerance, the rebuilding time depends on several factors, such as array size, array type, CPU, etc. You will then see the Rebuild % status in the Manage tab. Once repairs are complete, the array will update to “Status: Normal.”

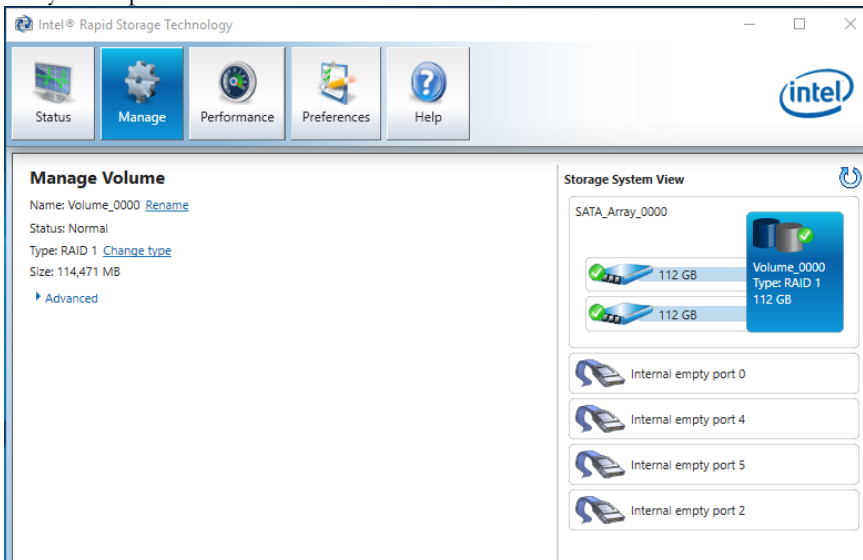

Partitioning and Formatting a drive

Once you have created your array, either from UEFI or from IRST, you will not initially see your array in “This PC.” This is expected, because even though you have created the array, you have not yet prepared the array to be used.

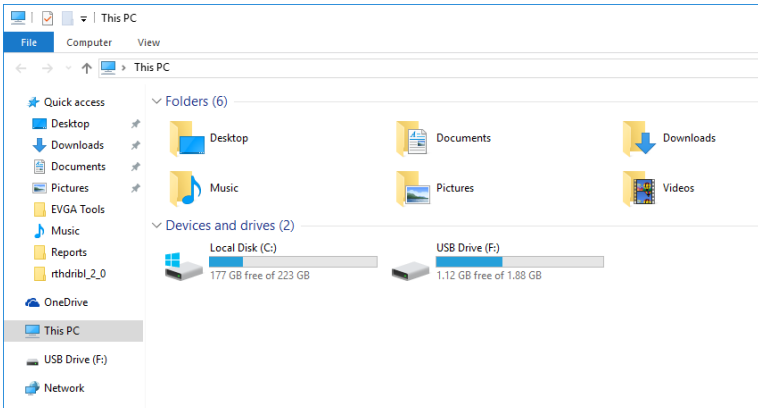

To begin, you'll need to go into Disk Management.

Windows 10: Right-click on the Windows Start button and select “Disk Management.” Alternatively, press the Windows Key + X on your keyboard and select “Disk Management.”



After “Disk Management” loads, you’ll see a pop-up to Initialize Disk if you’ve added a new drive or created a new array.

Generally, it’s recommended to select “GPT,” unless you need backwards compatibility with an old OS or PC. When you’ve made your choice, click “OK.”

Note: If you previously initialized your array through IRST, you will skip this step and move on to the New Simple Volume Wizard in the next step.

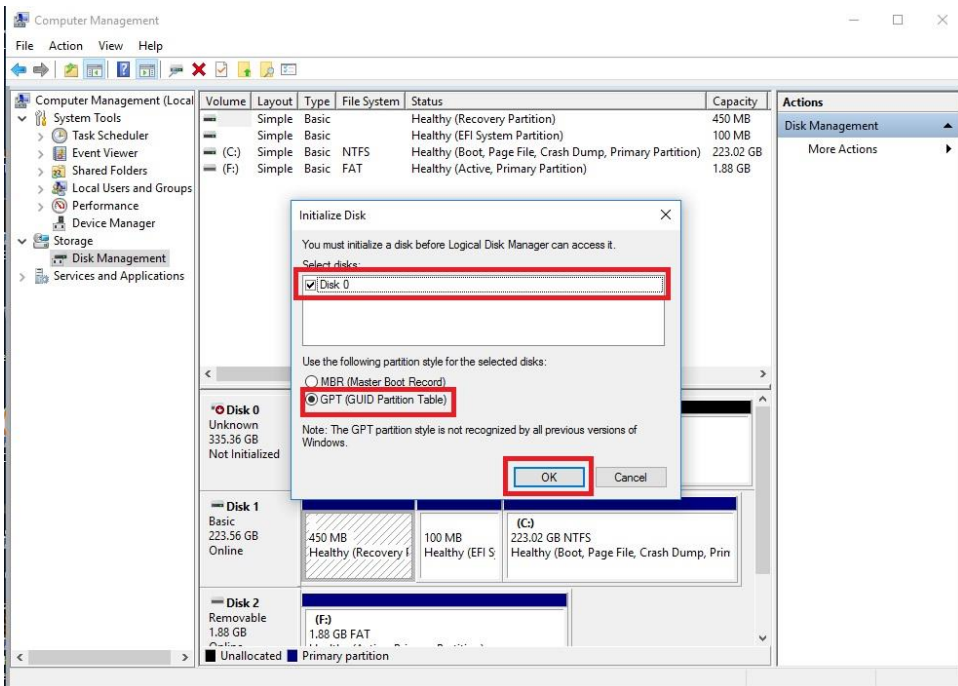

Before you can assign a drive letter to a drive or array, the initialized disk must be partitioned. If you are following this guide and just initialized your drive or array, the New Simple Volume Wizard will automatically pop-up.

If your drive or array is initialized, but not partitioned, the disk will appear in Disk Management as “Unallocated,” as shown in the image below. Right-click on the box containing “Unallocated” and select “New Simple Volume” (this text may vary slightly based on operating system). The New Simple Volume Wizard will pop-up.

When the window below opens, click “Next.”

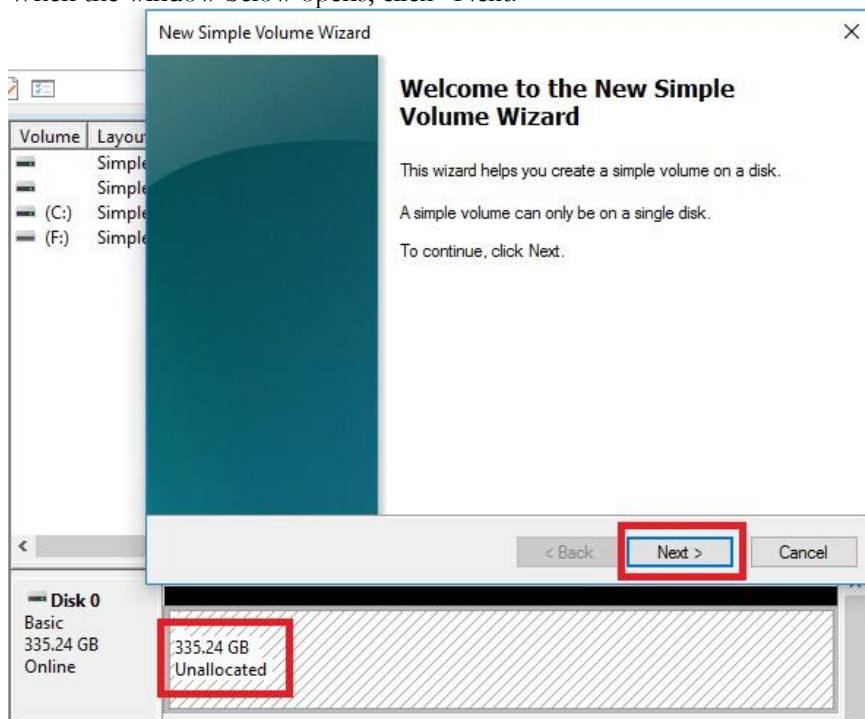

Leave the size at default to create a partition using the entire volume of disk space, then click “Next.” Select the drive letter you want to represent this drive, then click “Next.” Note: The drive letter does NOT have to be a consecutive letter with previous drive(s). Also, the wizard will not allow you to accidentally select the letter of a drive in use.

The image shows two side-by-side screenshots of the 'New Simple Volume Wizard' window. The left screenshot is titled 'Specify Volume Size' and shows the 'Simple volume size in MB' field set to 843283, with a red box around the input field. The right screenshot is titled 'Assign Drive Letter or Path' and shows the 'Assign the following drive letter' radio button selected, with a red box around the 'D' dropdown menu. Both screenshots have a red box around the 'Next >' button at the bottom.

The next step is to format the partition. Select your File System; NTFS is default, and generally recommended for most large drives. Check the box for “Perform a quick Format.” You may rename the volume, or leave it at default. Click “Next” when ready.

The image shows a screenshot of the 'Format Partition' step in the 'New Simple Volume Wizard'. The 'Format this volume with the following settings' radio button is selected. The 'File system' is set to NTFS, 'Allocation unit size' is set to Default, and 'Volume label' is set to 'New Volume'. The 'Perform a quick format' checkbox is checked, and the 'Enable file and folder compression' checkbox is unchecked. A red box highlights the 'Perform a quick format' checkbox and the 'Next >' button at the bottom.

After the quick format is completed, you will see the last Window of the wizard, a summary of the process, then click “Finish.” The drive is now usable.

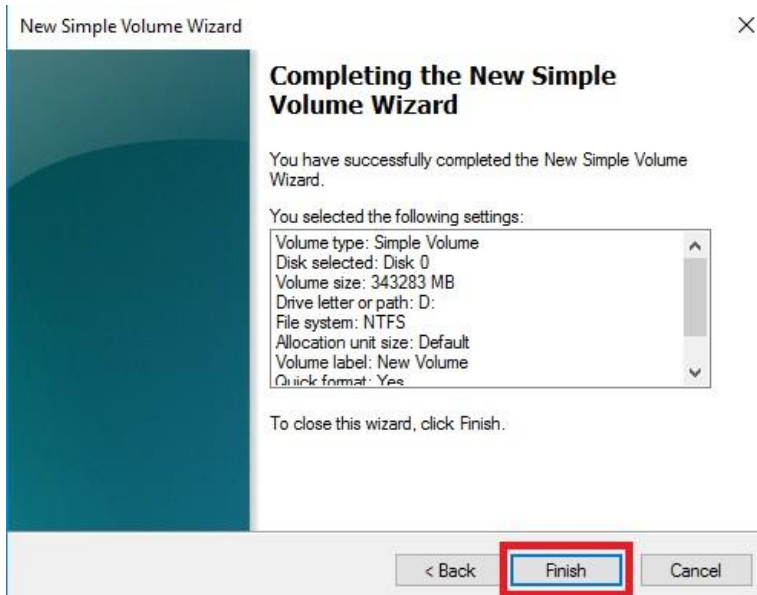

To confirm, go back to File Explorer in Windows. Click on “This PC” and check the drives section. You should have a new empty drive there, with the letter you designated.

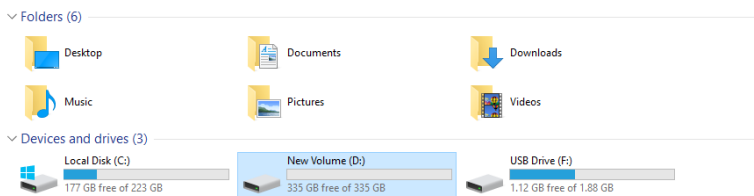

At this point the process of building an array and making it usable is completed.

Fan Header and PWM Setup

The Z490 FTW supports both 4-pin PWM fans and 3-pin DC fans. The motherboard uses seven 4-pin fan headers, including 2x CPU FAN (PWM), a CHA FAN (PWM/DC), a PWR FAN (PWM/DC), 2x SYS FAN (PWM/DC), and an AUX FAN (PWM/DC). You can locate each header on Pages 11 and 12, component numbers 3 and 4.

To configure the fans in BIOS/UEFI, first power on / restart the PC. During the POST sequence, press [Delete] repeatedly to get into the BIOS. Once in the BIOS, use the arrow keys or your mouse to navigate, whichever is easier, and make your way to the “Advanced” – “H/W Monitor Configuration” menu.



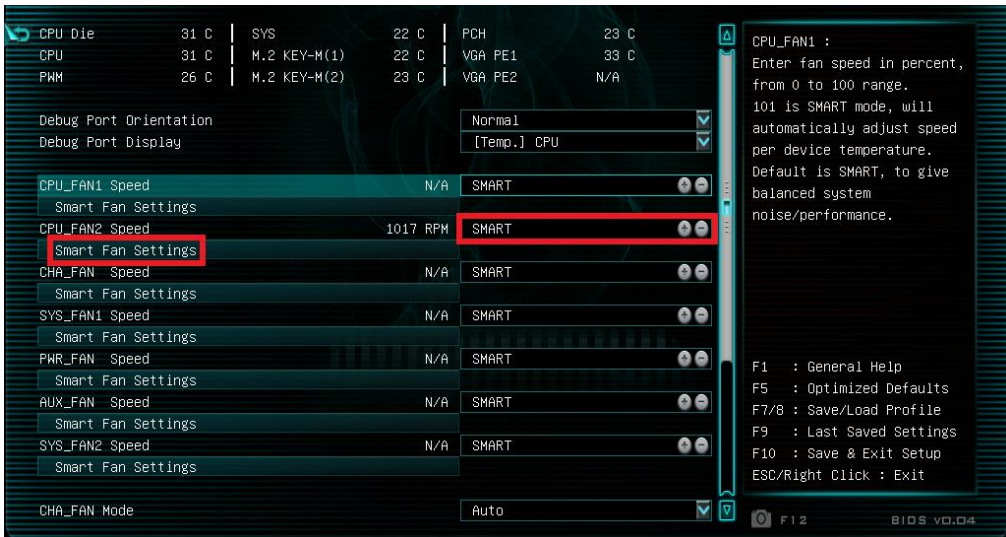

Once into the H/W Monitor section, you can see the temperature monitors across the top. Below the monitors, each fan is already configured in Smart mode, which means the fan controller is using a Smart curve for fan controls. Each fan can be set to a separate fan curve. To set a Smart curve, please see the guide starting at the top of the next page.

The +/- buttons next to Smart allow you to set your fans at a static speed percentage, instead of a curve. If you set the speed too low, however, the fan may stall; the stall speed will vary from fan to fan.

Below the CPU fans, you will see the five (5) PWM/DC fans: SYS_FAN1, SYS_FAN2, CHA_FAN, PWR_FAN, and AUX_FAN. The fan controller will automatically detect and set the fan to either PWM or DC.

Alternatively, the PWM/DC fan headers can be set to either PWM Mode or DC Mode, which can be selected by clicking on the pull-down menu. DC Mode will power the header using the static percentage set and the fan's maximum speed. PWM Mode will power the header and communicate via pulse with a supported PWM fan.

PWM mode is necessary if you are running a PWM fan powered by a different connector, such as a molex, SATA, or 3-pin header not on the motherboard. If you don't select PWM mode in this scenario, the fan may run at 100%, or behave erratically, regardless of the Smart Profile or percentage that you set above.

To set a Smart curve, select the “Smart Fan Settings” and enter the menu.

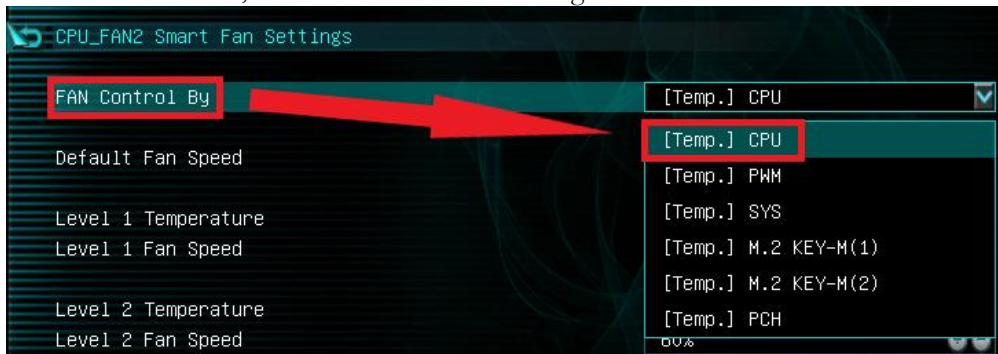

First, choose the temperature monitor the PWM controller will use to monitor for its temp information. It's recommended to link the fan control to the CPU, which is predominantly the most important temperature in the system. The exception is when you have 128GB of heavily overclocked RAM, which may cause PWM temps to be a concern. If this is a concern, set the fan control to the PWM temp.

Once you've set the Fan Control reference point, you can set the Default fan speed. The fan speed will increase once the temperature reference point has heated up enough to hit the Level 1 Temperature. Once it hits the Level 1 Temperature the fan controls will override the Default speed setting based on the temperature at the time.

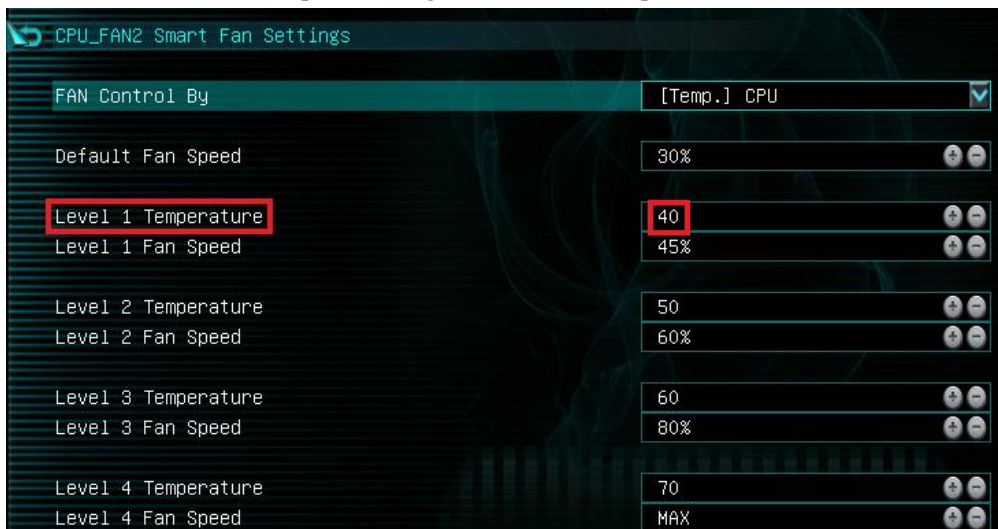

There are four tiers of temp control, with Level 4 fan speeds generally recommended to be set at Max. The example above uses a fairly aggressive fan curve, but you can set this as high or low as you wish. Make sure, however, to stay below 5-10C of the Max safe load temp for your specific processor, which can be found at Ark.Intel.com. All Smart Fan Settings have the same controls and can be setup the same way.

When monitoring temperatures vs. fan speed, you may notice a variance in ramp up/down temps; this is due to a function EVGA hardcodes into the BIOS called Hysteresis. Hysteresis builds in a buffer to control fan speed behavior. This feature prevents a constant ramp up/down from happening when your system sits exactly at the temp you set for SMART fan controls. For example, if your setting is at 30C and you hit 31C, the fan will ramp up and cool down to 29C, letting the fan slowdown, which lets the system heat back up to 31C again, repeating indefinitely and causes the system to sound like it's breathing. Hysteresis adds a 4C +/- buffer for CPU and PWM, and 2C +/- for SYS. This means that once a fan based on the CPU or PWM temp brings you down to 30C, it will not ramp back up until 34C, so you have a buffer. If you base the fan control on the SYS temp, you will only see 2C variance.

Setting Up SLI and PhysX

SLI and PhysX are NVIDIA developed technologies supported by EVGA motherboards. SLI is a means of dividing the graphical load between multiple video cards, similar in theory to how dual- or quad-channel memory works, or even how RAID0 works. However, the software (e.g. game) needs to support SLI to gain from this technology.

PhysX is an NVIDIA technology that can be assigned to a graphics card or CPU for programs supporting NVIDIA PhysX. As long as the PhysX driver is installed, which occurs during a normal NVIDIA GeForce driver installation, the system will allocate resources to support PhysX based on CPU or GPU load. You may, however, go into the NVIDIA Control Panel and dedicate the CPU or a GPU to this function manually. For a complete list of NVIDIA PhysX supported titles, please see this link:

<https://www.geforce.com/hardware/technology/physx/games>.

SLI requires two or more video cards that support SLI; have the same GPU family (GTX 2080 Ti, GTX 980, etc.); have the same memory type (GDDR6, GDDR5X, etc.), volume (11GB, 8GB, etc.), and datapath width (128bit, 256bit, 384bit, etc.). SLI also requires a motherboard that supports SLI, and an SLI or NVLink bridge for each card in SLI. Providing the above conditions are met, compatible graphics cards with different GPU and/or memory clock speeds will not prevent SLI from being enabled.

Note: For questions and concerns regarding NVIDIA Surround™ and full setup instructions, please see <https://www.geforce.com/hardware/technology/surround/system-requirements>. As the possible combinations of setups between SLI, monitors, and cabling are far too vast to label in this manual, also see <https://www.geforce.com/whats-new/guides/how-to-correctly-configure-geforce-gtx-680-surround> for a basic setup walkthrough.

Installation:

1. Physically install your graphics cards, then install an SLI or NVLink bridge; examples include a Flexible bridge (included with this motherboard), an EVGA HB Bridge or NVLink Bridge. Current NVIDIA graphics drivers support 600 Series cards up through GTX 2080 Ti and Titan RTX cards. Driver support is determined by NVIDIA; please check GeForce.com to confirm compatibility with drivers and SLI.

Once the graphics cards are physically installed, connect an SLI or NVLink Bridge; your cards should look similar to either picture below:

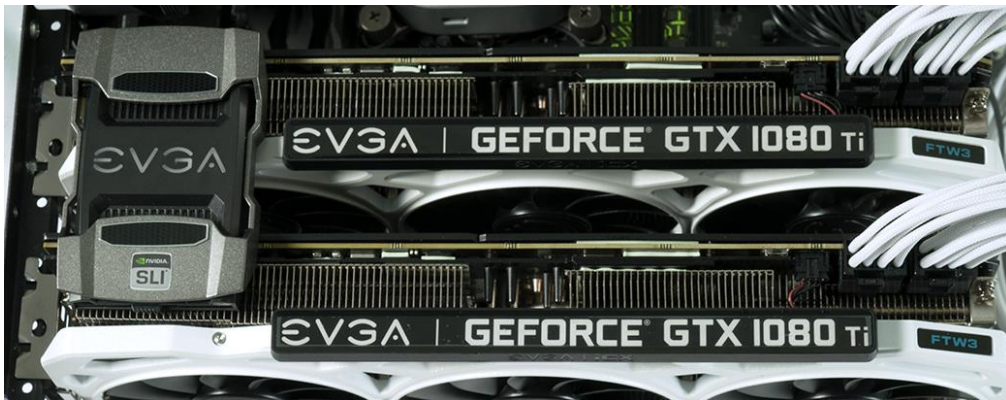

2. After the cards are installed, have power connected, and the SLI/NVLink bridge is attached, boot into Windows. The graphics driver will normally identify the cards and automatically configure the driver. If not, then you may need to reinstall the driver.

Once finished, you will receive a popup in the lower right corner stating that you have an SLI capable setup and it needs to be configured. If you did not see the message, then first verify that both cards are detected and functioning without system errors from Windows Device manager.

Right-click on the Start menu and select Device Manager.

Under “Display Adapters” you should see the type and number of video cards you have installed.

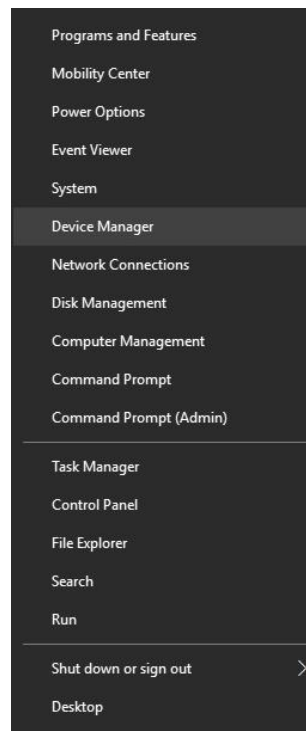
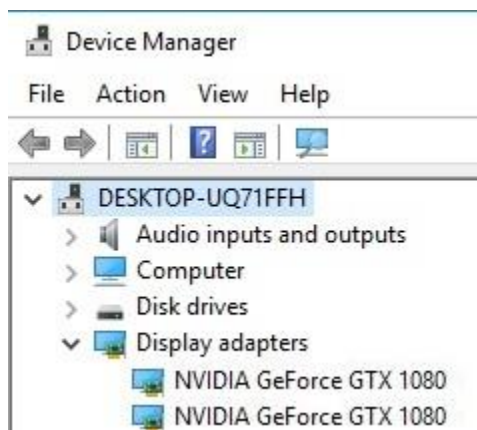

3. Once you have verified there are no detection/driver installation issues with the cards, you can enable SLI. Right-click on the desktop and select “NVIDIA Control Panel” (“NCP”).

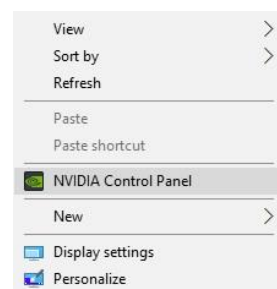

Next, select “Configure SLI, Surround, PhysX” under the “3D Settings” menu. The default is “Disable SLI.”

To enable SLI, click “Maximize 3D Performance,” circled in red below, and click “Apply” at the bottom.

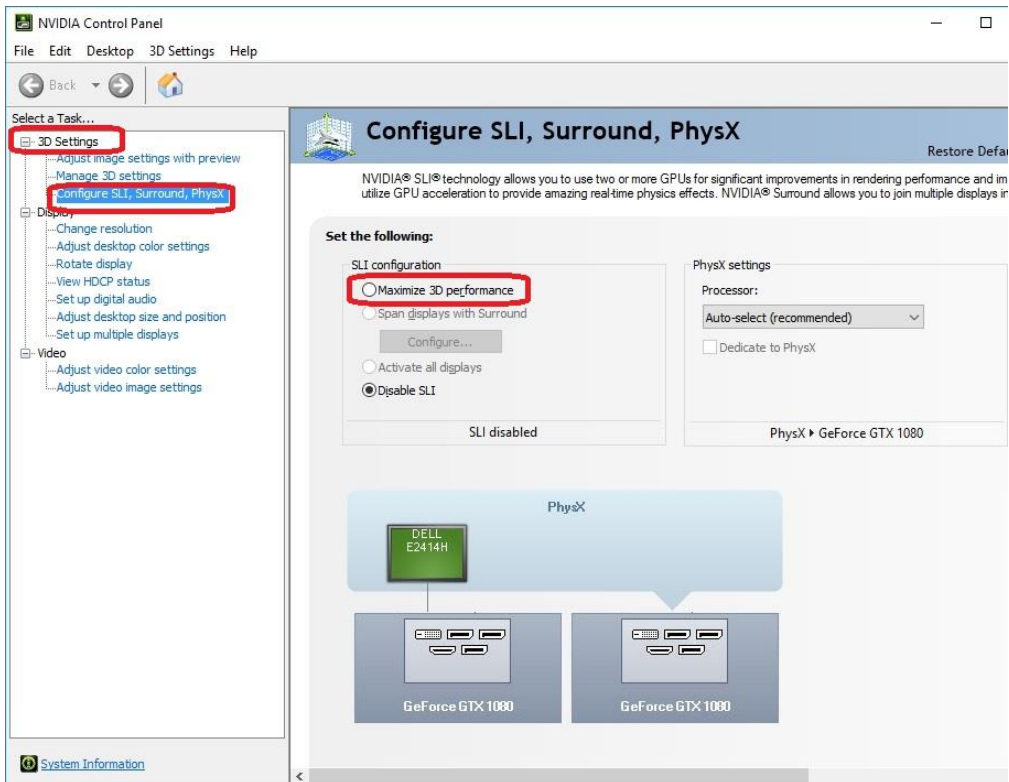

Before you can enable SLI, the NCP may ask you to close certain programs and processes; you cannot continue further until this is completed.

At this point the display may go black a few times, or appear to change resolution and back again quickly; this is normal. Also, if you are running a G-Sync monitor, it will turn off and on during this process, which may take between 5-20 seconds, approximately.

4. Once finished, your SLI configuration should look similar to the image below. The key aspects that show an optimal configuration are circled.

5. OPTIONAL. With multiple cards, you can assign one to PhysX, but we do not advise choosing that OVER SLI, because SLI will provide substantially larger performance gains. In general, leaving PhysX on “Auto-Select (recommended)” is recommended. When left on Auto, your PC will adjust the PhysX duties based on overall system load, which, in many cases, will be the CPU. Otherwise, manually setting the PhysX processor is best when a spare graphics card is in the system.

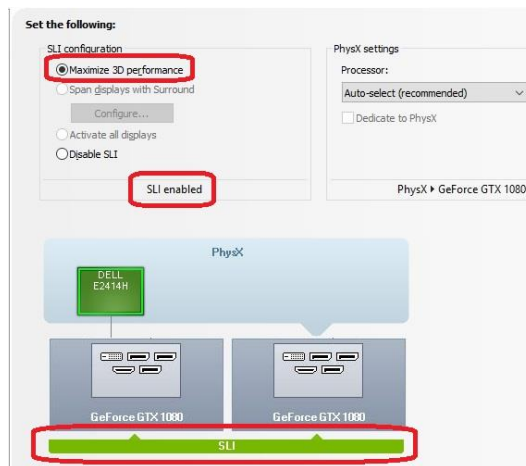

While SLI is a direct performance enhancement PhysX is used for visual enhancement, allowing the physics of various items in the environment to be calculated live. A dedicated PhysX card keeps the load localized to a device that has no other current function. Although frame rates may only increase slightly, a dedicated PhysX card keeps the frame rate from spiking in either direction when there are very intense and abrupt uses of PhysX. For certain titles that heavily utilize PhysX, a dedicated PhysX card can be beneficial to help stabilize the frame rate.

If you do not have a spare card to dedicate to PhysX then it is advised to leave the PhysX Setting to "Auto-Select (recommended)." The general rule of thumb for needing dedicated PhysX is this: Does your game support NVIDIA PhysX? (Yes or No). If “No,” then a dedicated PhysX card serves no purpose. If “Yes,” then the next step is to see if your GPU has a high usage rate while playing normally. Use a program like EVGA Precision X1 to monitor the GPU usage of all current video cards. If the GPU is consistently over 75% usage, the GPU usage occasionally maxes out and the frame rate drops in moments of intense action, then dedicating a card may be beneficial. However, if this does not occur in your setup, then leaving your system to handle the PhysX load without a dedicated card should be fine, since the default setting will balance the PhysX processing between the GPU and CPU based on load at any given moment.

If you need further help setting up SLI/PhysX, please contact EVGA Customer Service.

Realtek HD Audio Manager

The Z490 FTW uses a 7.1 Channel Realtek ALC1220 audio controller. This section will cover installation of the controller (in Windows 10) and the basic configuration options that are available in the software.

To begin, use the drivers on the included USB flash drive or download the current Realtek drivers from <https://www.evga.com/support/download>. Once downloaded, right-click to extract the file and run the correct driver for your operating system. Once launched, select “Next” on the extraction window, “Next” on the installation window, then select “Yes, I want to restart my computer now.” Click “Finish.”

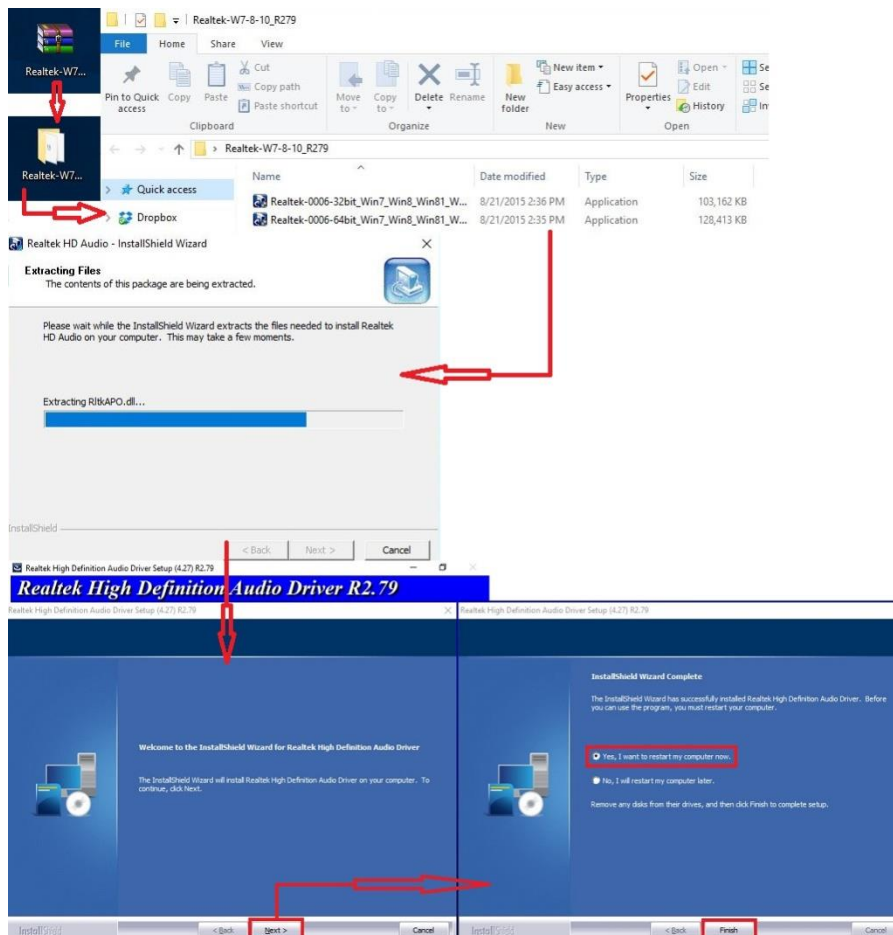

Once you have rebooted and re-entered Windows, there should be a new shortcut in the system tray with a red-orange speaker icon. When you mouse over it, the icon reads “Realtek HD Audio Manager.” When the menu opens, left-click on it, and left-click the similar red-orange speaker icon labeled “Sound Manager” to launch the Realtek software front-end.



The below images are all composites, showing the popup texts for multiple buttons/menus on screen at once to reduce the picture clutter; however, you will not see the same popups simultaneously in the Realtek HD Audio Manager.

Once the Sound Manager is open, you will be able to configure several aspects of the sound output. First on the main screen is a side-panel showing the devices physically-attached to the Realtek controller. See Page 13 for output jack legend.

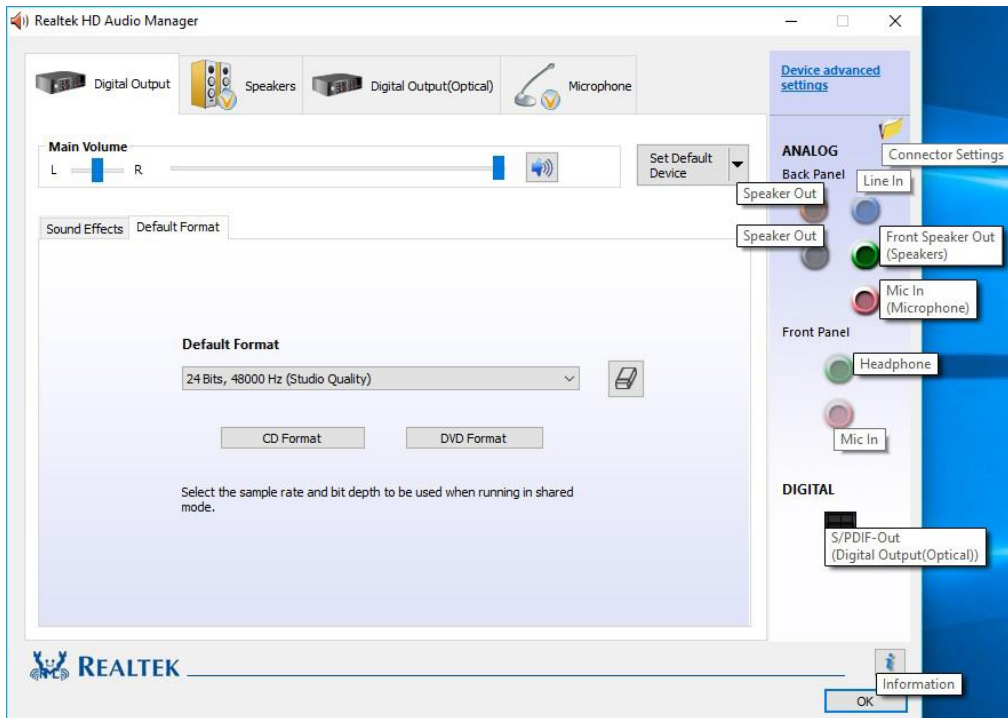

On the right margin, you can see the different ports labeled in the picture above. The top portion covers the five (5) analog ports on the I/O Hub. The two (2) labeled “Speaker Out” ports and “Line In” port all use a diffused color to show that a port is not currently connected; conversely, “Front Speaker Out (Speakers)” and “Mic In (Microphone)” use a solid color to show that the ports are currently connected. For locations and a picture of the ports please see Page 11 component number 30, and Page 13 for the I/O Hub component number 11.

The center section of the side panel is for Front Panel Audio. Although the Front Panel Audio ports will display in the Control Panel, and will notify you that Front Panel devices are presently connected/disconnected, Front Panel Audio only plays through EVGA NU Audio. The Front panel header can be found in the component legend on Page 11 component number 22, additional port information on Page 19, and a header pinout on Page 47. EVGA NU Audio information can be located on Page 117.

The bottom section of the side panel is “DIGITAL.” This represents connections via optical S/PDIF, typically going to a receiver or TV. For locations and a picture of the port please see Page 11 component number 30, and Page 13 for the I/O Hub

component number 10. The optical out contains all audio data the controller can provide; however, only 2.0/2.1 is pre-encoded from the controller. Audio with a higher channel count through optical S/PDIF must be connected to a receiver that supports live encoding, or an equivalent technology.

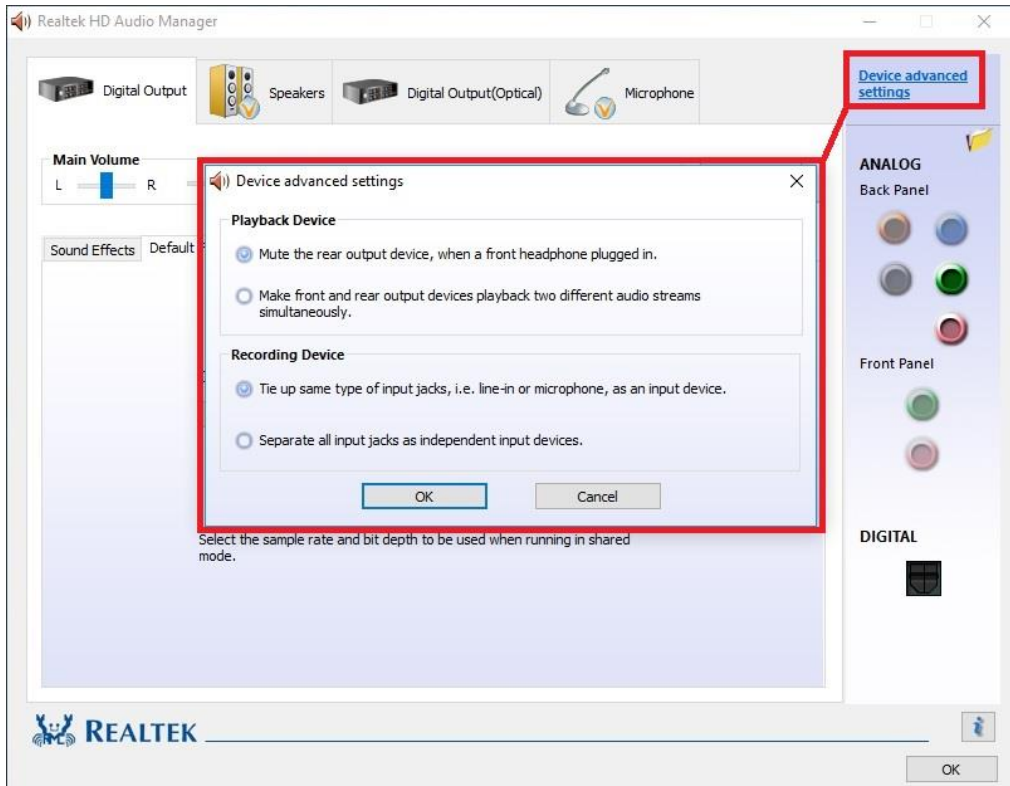

Also on the side panel is the “Device Advanced Settings” button. This will bring up a popup menu with options for playback and recording devices. Both options in Playback Device and Recording Device are mutually exclusive within their respective sections. The top options are default for both. Once you have made your selection, click “OK” at the bottom.

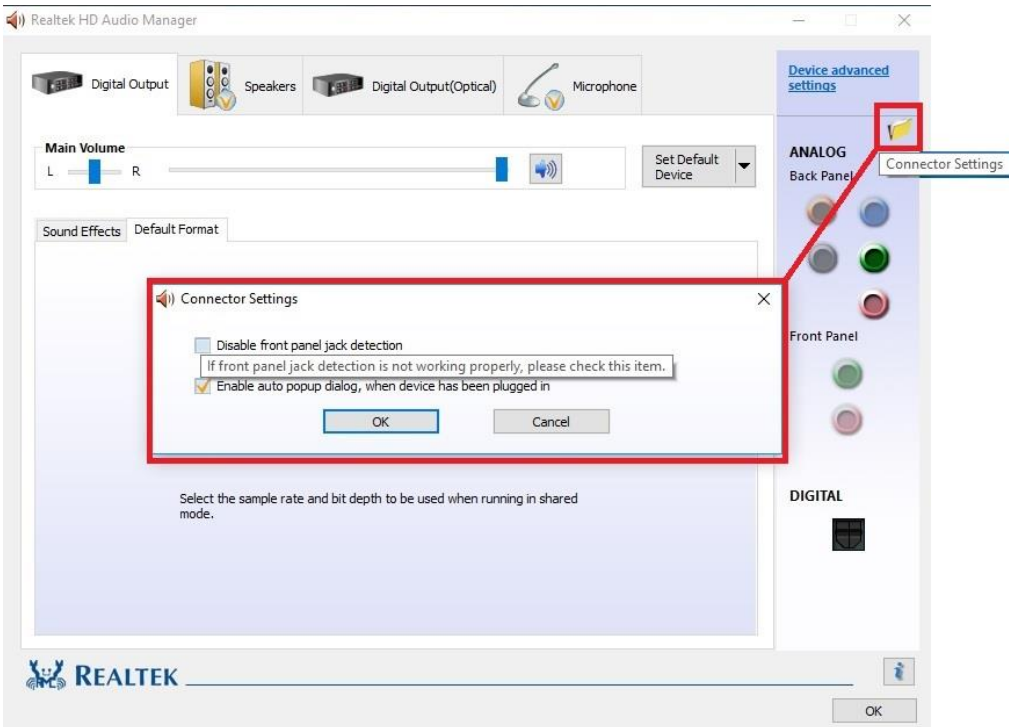

The icon of the file folder in the upper right is “Connector Settings.” This is the window for setting up port detection. The default setting in this Window allows the Manager to create a popup notification to let you know when you’ve plugged in a new device to a Realtek port while Windows is running. The popup box will let you confirm which device you’ve plugged in (e.g. after plugging in a microphone cable, the popup box may incorrectly select “Line In,” which you should then change to Microphone). If you’d prefer to disable this notification, then deselect the “Enable auto popup dialog” option.

The “Disable front panel jack detection” option is mostly used for troubleshooting in cases where the Realtek Manager refuses to acknowledge speakers plugged into the rear ports, causing no sound to come out from your speakers. Should you run into that problem, checking the box for this option will often fix situations where audio will not play. If you plan on using your front panel audio connectors (e.g. the speaker/mic ports on a chassis), then do not disable the front panel jack detection. The disable box *ONLY* applies to the front panel, whereas the “Enable auto popup dialog...” covers ALL Realtek interfaces.

The “i” located at the bottom right of the Manager is an information button. Clicking on this will provide DirectX information, the CODEC and Language selection options.

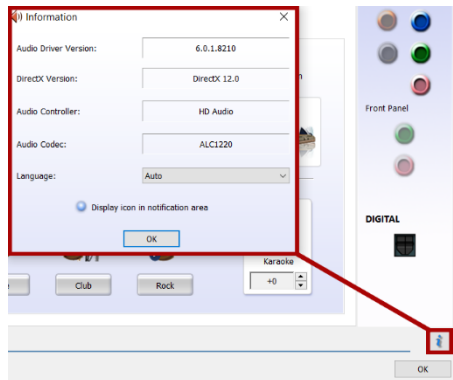

The main page defaults to the first audio device it detects; device response time to the controller can vary, so the order listed here may not be the order ALL components are detected. The Manager will generally only show devices detected by the motherboard. For purposes of this guide, speakers, a microphone, and a TOSLINK digital audio cable are

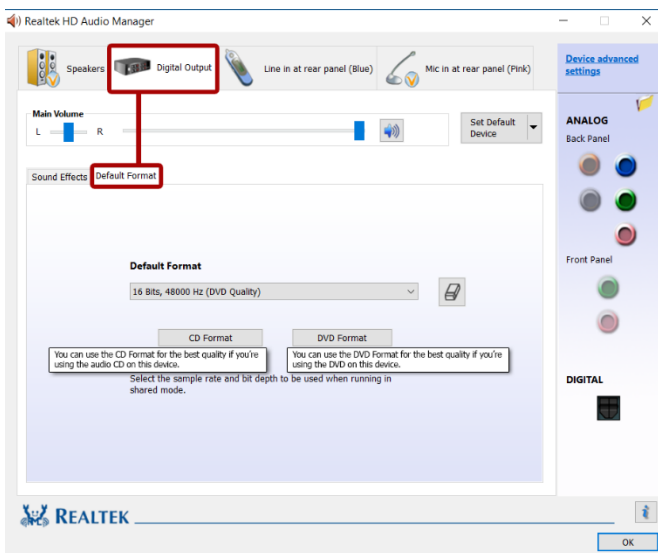

connected. As a result, the Manager detects the Digital Output first. You should also see a “Digital Output (Optical)” at the top. This shares all the same options as “Digital Output;” the difference is strictly connection type.

In the “Default Format” section, there are a couple basic selections of “CD Quality” and “DVD Quality,” which allow you to select optimized presets based on standards of how the media is recorded and written to a disk for those formats. Use the pull-down menu if you prefer to set the bit-rate and frequency yourself. All audio devices shown will have a Default Format section. Adjusting the frequency too low will heavily reduce audio quality, moving it too high can impact overall performance and cause other anomalies.

To the right of the pulldown is the Restore Defaults button, shown by an eraser icon, which will reset any changes made to the default of the controller.

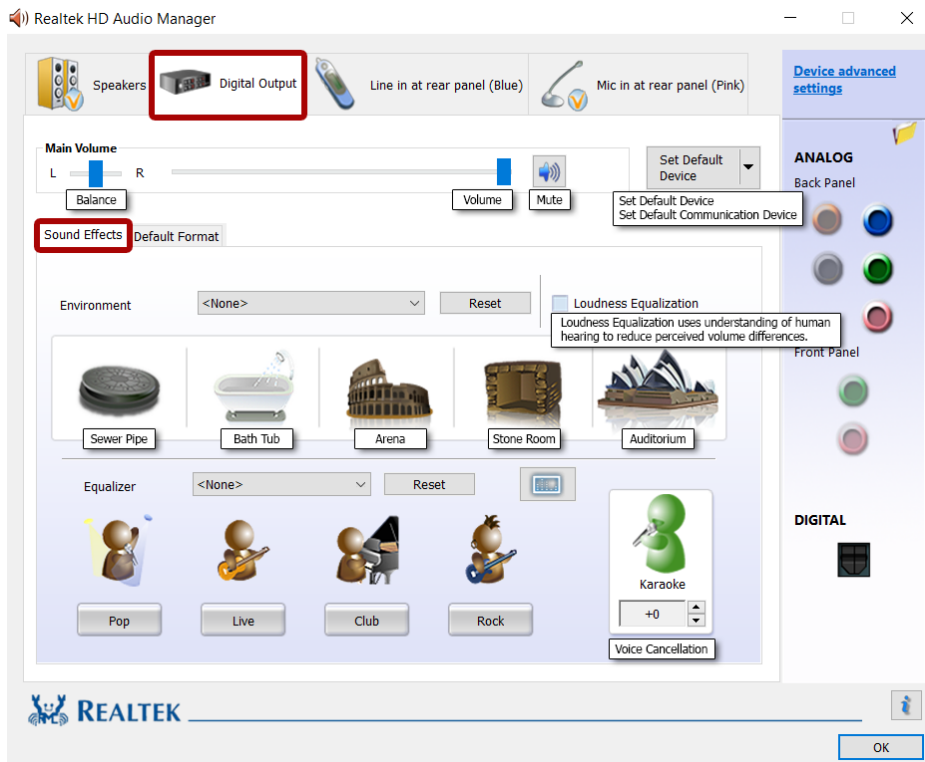

If you switch over to the Sound Effects tab, you'll notice the "Main Volume" controls near the top. The slider directly under Main Volume adjusts the Balance of your speakers. It is generally recommended to leave the slider centered, since most audio is meant to run with the audio output centered; this setting is mostly to compensate for either off-center speaker configurations or individuals suffering from partial hearing loss.

To the right of Balance is "Volume;" this is the volume control for the Realtek software but also adjusts Windows main volume; this will also work similarly to a pre-amp if your speakers have a separate volume control that controls the volume after leaving the PC but before reaching the speakers. For this reason, many modern speaker systems use sequential volume controls working additively off each other.

To the right is the Mute button. This is tied-in with the Windows volume; clicking this button will Mute all audio output in Windows. Click again to restore audio.

The “Set Default Device” will allow you to set the Default Device or Communication Device without entering the Windows Playback menu; for non-default devices, this box will drop down similar to the image above. For default devices, the box will be grayed-out if the device selected above (i.e. Speakers, Digital Output, etc.) is the default device.

Below the Main Volume section is the “Sound Effects” and “Default Format” section. “Default Format” was previously covered on Page 104. Under “Sound Effects,” you’ll find Environment, Loudness, and Equalizer options.

Environment is defaulted to “None,” which means the sound will output how it was originally recorded.

This section allows the Realtek controller to simulate different acoustic environments before delivering it to the speakers so the sound will emulate an arena, an auditorium, or even a bathroom.

If you want a preset other than what is available on the main screen, click the pulldown box next to “Environment,” which defaults to <None> and contains a list of 24 total options.

You can revert the sound effects back to a default state anytime by clicking the "Reset" button.

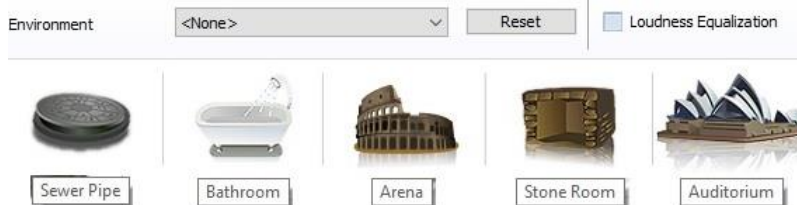
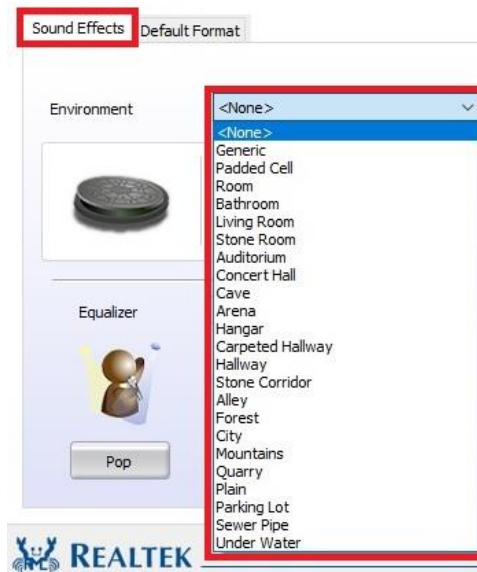

To the right of the Reset button is the “Loudness Equalization” setting. This is effectively volume normalization, which is a setting designed to prevent drastic volume changes in music, movies, games, etc. from one audio source to the next, much like many TV’s utilize to prevent a sudden increase in volume when switching from one channel to the next. This is a good setting if you prefer to avoid volume going higher than you want; however, you may lose some audio quality, depending on the audio

source. This is unchecked by default. There is no additional configuration; the setting is either enabled or disabled.

The last section in Sound Effects is the Equalizer. Much like the environment section, there are visual references for presets, a pull-down with 14 options, and a more traditional equalizer setup with a 10-band EQ as part of the software suite.

You can select any of the presets that will provide you with basic optimizations for your music preference. To see the entire list, click on the pull-down menu that reads <None> and a pull-down with all presets becomes available. Including “<None>,” there are 14 in total.

If you prefer to set your equalizer values manually, click on the equalizer icon to bring up the 10-band equalizer. This will bypass all presets and enable manual control.

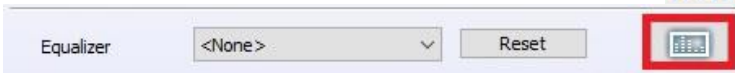

From here, you can adjust the tone of the music by raising or lowering the slider on each frequency band.

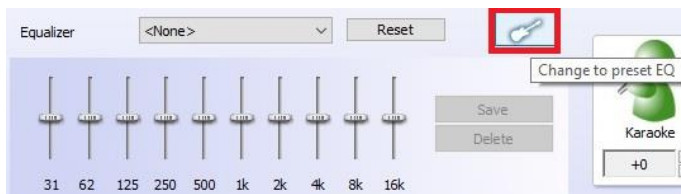

You can make multiple presets of your own, which will appear in the pull-down after you have saved them. The presets each have their own benefits, but cannot take into account your audio equipment, room acoustics, or subjective audio preferences. Creating your own EQ profile allows you to further customize your audio to account for additional musical options, such as Thrash Metal, Country music, Opera, etc. to match your specific tastes.

If you would prefer to not manage the EQ in full manual mode, you can click the guitar icon with the red box around it to bring you back to the equalizer presets menu.

The last section in Sound Effects is voice cancellation, also called Karaoke mode (this should not be confused with noise cancellation options in the Microphone menu). By left-clicking the icon, a red X will pop up, as shown in the image to the right. When the red X is present, the Realtek controller uses an algorithm to suppress vocal sounds from the audio source, while keeping instrumental sounds, much like a karaoke machine.



Underneath Karaoke is a menu for changing the key of the music playing. Raising the value (up to +4) will raise the pitch of the music and voice, while lowering the value (down to -4) will lower the pitch of the music and voice. This setting is designed to add a fun effect to your audio; it generally should not be used as a means to “fix” audio.

The next device section is “Speakers,” which is where you can configure all of the output options while using the analog connectors on the back.

This section will focus on the “Speaker Configuration” and the “Room Correction” tabs. The other tabs, “Sound Effects” and “Default Format,” are identical in each section, and were previously covered on Pages 105 and 104, respectively.

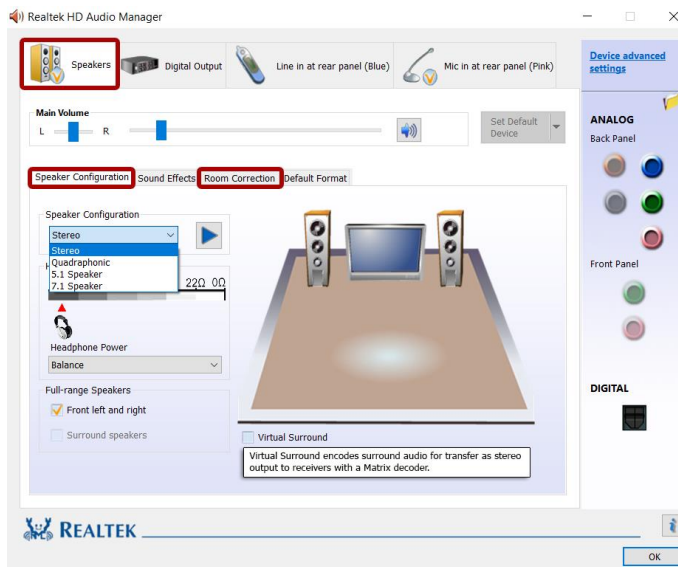

The first option in “Speaker Configuration” is the pulldown menu for Stereo, Quadraphonic (4.0), 5.1 Speakers, and 7.1 Speakers; there is no support for 4.1 audio.

The “Audio Test” button will be present for all speaker configurations, and serves the same function in all speaker iterations.

Pressing the “Auto Test” button will play the same sound file out of each speaker that should be present, based on the configuration option you selected. As the sound test plays, an animation will highlight the speaker the sound should be coming from, this will help to ensure that the speakers are connected correctly and oriented correctly, as well.

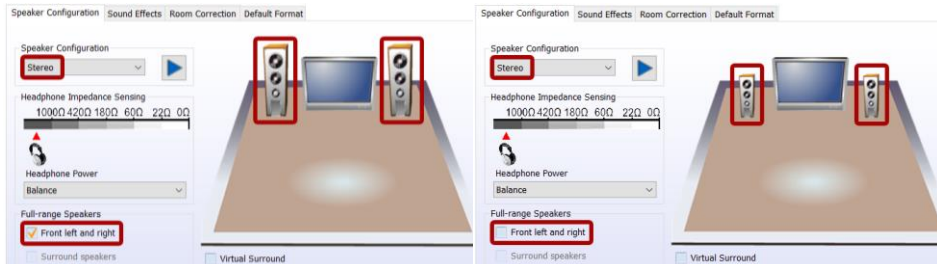
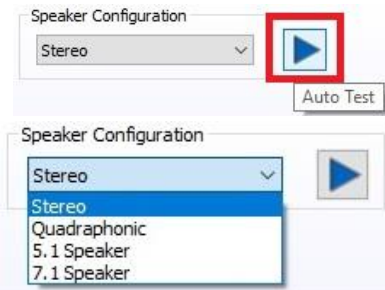

In the lower left, there is a pair of checkboxes labeled under “Full-Range Speakers.” Full-range speakers are designed using drivers that can independently output audio across a wide frequency response of (20Hz-20,000Hz +/- 3dB) at the same volume level. When this setting is enabled, Windows will disable its software crossover settings and send the full frequency range to the speakers, whereupon the speakers will engage its own hardware crossover filters to appropriately direct audio to the individual drivers.

If your speakers are not full-range, they will not have necessary hardware components to play low frequencies, nor are they designed for that purpose. When the full-range option is unchecked, the Audio Manager will instead send the full signal out using crossover settings, available on 5.1/7.1 by selecting the Bass Management option. This sort of signal will send out the full audio frequency such that the majority of the frequency will go to the speakers, but direct the low frequencies to a subwoofer. This way, you’ll still get the same sound, but you must select the correct options.

To determine if your speakers are full-range or not, you must look at the minimum frequency response of your speakers. The concern is not the high-end of the frequency response, but rather the low-end. As noted above, if your speakers are not rated for a minimum of 20Hz, then they are not full-range speakers. Here are some considerations:

- Assume your speakers are not full-range. Modern speaker design uses a subwoofer to handle the relatively small percentage of content you hear in an audio signal. Low frequency content, more commonly known as sub-bass, is greatly amplified by the subwoofer, which explains why the smallest percentage of your audio content can often be the loudest. The subwoofer allows the speakers to concentrate on the remaining 99%+ of the audible frequency bandwidth.
- Generally, if your speakers came with a subwoofer, they are not full-range speakers. As noted above, subwoofers are designed, in part, to allow speakers to stay clear of the low frequencies. When examining the specs of the speakers, make sure to look at the frequency response specifically of the speakers, and not just the specs of the speaker system. Sometimes, the most easily available specs may include the subwoofer, which can go as low as 18Hz +/-2 dB; the minimum frequency of the speakers, however, may be much higher.
- If you have a 2.0 stereo setup, look for the frequency response specs. If they do not have at least a 20Hz to 20kHz range, then they are not full-range speakers. You may try full-range, but you will lose any audio data below the minimum frequency of your speakers or may hear distortion at lower frequencies.
- Headphones tend to be full-range speakers, as they are designed to operate without a subwoofer. However, the quality of your headphones will determine whether you should configure them as full-range or not.
- If you use a receiver or your speaker system has its own controls for the type of speakers, do not use the full-range setting in the Creative panel without consulting the instructions of your receiver or speaker system, since it's possible that your receiver or speakers prefers full-range, so that the receiver or speaker system will utilize its own crossover settings once receiving the full audio range.
- Lastly, audio equipment quality will have the greatest effect on whether you should set full-range, or not. Very few speakers are properly designed for full-range audio, and if they are, then they will likely be very expensive.

Two last considerations: First, do not set Headphones to full-range if using the Headphone Surround option (may be listed as Virtual Surround), as Surround will not work properly in full-range mode. Second, do not enable full-range mode for 5.1 audio or the bass redirection will not work properly. The only exceptions to 5.1 and full-range is that you either 1) have a full or partial set of full-range speakers in your setup, or 2) you are using a receiver or speaker system that prefers to handle the low frequency crossover at the receiver or speaker system, rather than using the Audio Manager to configure the crossover settings for low frequencies.

When Full-range is enabled, the speaker icons are enlarged to represent the change.

Finally, Virtual Sound is an option created to send a stereo signal with positioning data to a Matrix decoder to simulate surround over a stereo signal.

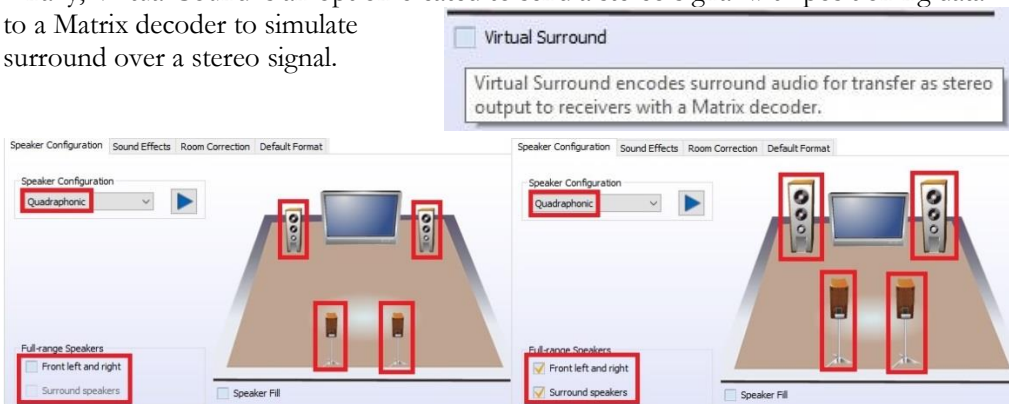

Quadrasonic and above will have similar options for Full Range: the checkboxes for “Front Left and Right” and “Surround Speakers,” which controls the satellites.

Under Quadrasonic, there is an option labeled “Speaker Fill.” This feature uses an algorithm to manipulate a stereo audio source to create a virtual surround effect using additional speakers.

5.1 and 7.1 add more options. “Speaker Fill” carries over from Quadrasonic, but also includes “Swap Center / Subwoofer Output” and “Enable Bass Management.”

Speaker Fill is still a virtual surround sound emulation feature for stereo audio sources, but not a true surround.

Swap Center / Subwoofer output is an option because the Realtek controller shares the subwoofer port with the front (stereo) speakers on the rear panel audio. As the tooltip notes, if low frequencies are not playing on the subwoofer, you must enable this setting. Also, most surround speaker sets use both the front pair and subwoofer on the same channel and voice speaker on a separate channel; in some instances, this is

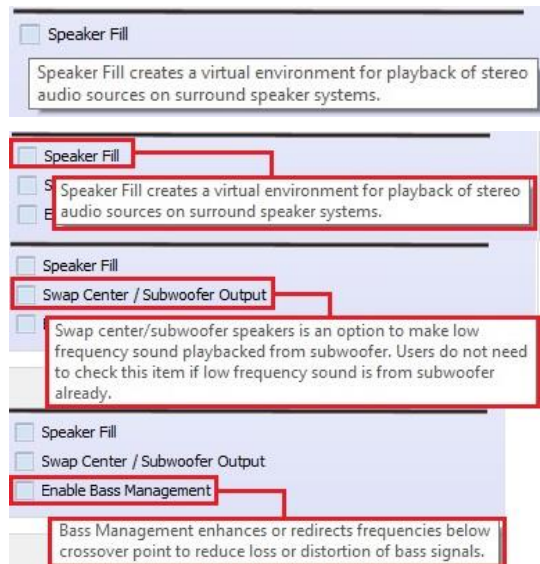

reversed such that the voice channel is joined with the front pair on one channel and the subwoofer has a dedicated connector, which can lead to voice channels and subwoofer receiving the wrong signal. The "Swap Center / Subwoofer Output" can resolve this type of issue. Please first confirm the subwoofer is installed correctly, however, by using the Component Legend on Page 13, and by consulting your speaker set's manual.

Enable Base Management (on the previous page) is a setting that attempts to keep audio data that may be lost or distorted near the frequency crossover point for the subwoofer and satellite speakers. On a system that does not use full-range speakers, this is a crucial setting for ensuring that your speaker system correctly plays low frequencies. The default frequency is set to 80Hz, but your system may need adjustment.

To properly set the crossover frequency, look at the specs for both your speakers and subwoofer. Some pre-assembled speaker systems may tell you what to set the crossover frequency to in your instruction manual. If not, then look for the minimum frequency response of your speakers (i.e. 75Hz, 80Hz, 175Hz, etc.), and the maximum frequency response of your subwoofer (i.e. 60Hz, 80Hz, 120Hz). Once you have that information, you can set the crossover frequency.

Ideally, you'll want to make sure that the crossover settings provide enough room to set the crossover frequency a little higher than your speakers' minimum frequency response, which will reduce distortion and provide a smoother transition to your subwoofer. A good rule of thumb is to set the crossover frequency about 20Hz higher than your minimum speaker frequency response. However, you may run into three different scenarios:

First, the frequency response of your speakers (e.g. 60Hz) and subwoofer (e.g. 100Hz) nicely overlap. This is ideal. Using the general rule above, you would set the crossover frequency to 80Hz and call it a day. You should still test the audio to ensure it is free of distortions, but this provides enough room to pass the low frequencies to the subwoofer and keep the higher frequencies to the speakers, without creating a conflict.

Second, the maximum frequency response of your subwoofers is exactly the same as the minimum frequency response of your speakers. In this case, you must set the crossover frequency exactly to where the subwoofer and speakers meet.

Third, you may have a situation where your speakers' minimum frequency response (e.g. 100Hz) is higher than your subwoofer's maximum frequency response (e.g. 80Hz). This should only happen if you purchased the subwoofer separately from the speakers. This setup cannot work properly, and you must replace either the speakers or subwoofer. Although you can adjust the setting to either the subwoofer's maximum frequency response or your speakers' minimum frequency response, you'll lose the audio data between those frequencies.

The Realtek HD Audio Manager, unfortunately, does not contain the ability to adjust the crossover frequency settings. Instead, you must adjust the crossover frequency via a registry edit in Windows. Due to the advanced nature of editing the Windows registry, we do not provide instructions in this manual. However, if you would like to adjust the crossover frequency settings, please see our FAQ on the EVGA website to walk you through how to adjust this setting: <https://www.evga.com/support/faq/?f=59663>.

The 5.1 and 7.1 configurations include the section “Optional Speakers.” This allows you to disable satellite speakers in pairs to bring any 5.1 or 7.1 system down to stereo. This is mainly used as a diagnostic tool for testing sound issues.



In the image above, speakers become transparent in the image when they are unchecked; this is to give you a visual reference of which speakers are enabled and disabled when testing for sound.

The last section under “Speakers” is “Room Correction.” This section allows you to virtually position the speakers using the software to ensure that the surround effects are positioned correctly based on physical distance.

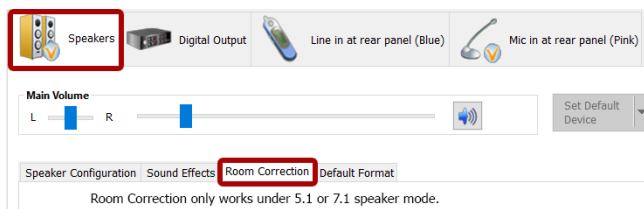

This is **ONLY** supported in 5.1 and 7.1 and you will receive the message to the right if you open the “Room Correction” tab in Quadraphonic or Stereo mode. If 5.1 or 7.1 is installed and setup in the “Speaker Configuration” page, you will see the full

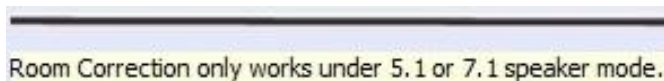

Room Correction menu without an error message. All speakers will initially show semi-transparently. To edit this menu, check the box for “Enable Room Correction” at the bottom-center.

After you check the box to Enable Room Correction, you will need to select whether you want distances displayed in Feet or Meters. Once selected, the unit of measurement will be colored in light orange, and will be reflected in the measurements below for each speaker. From here, enter the measurements from the seating area to each speaker. Once the distances are entered, test the audio and adjust the gain value to your liking.

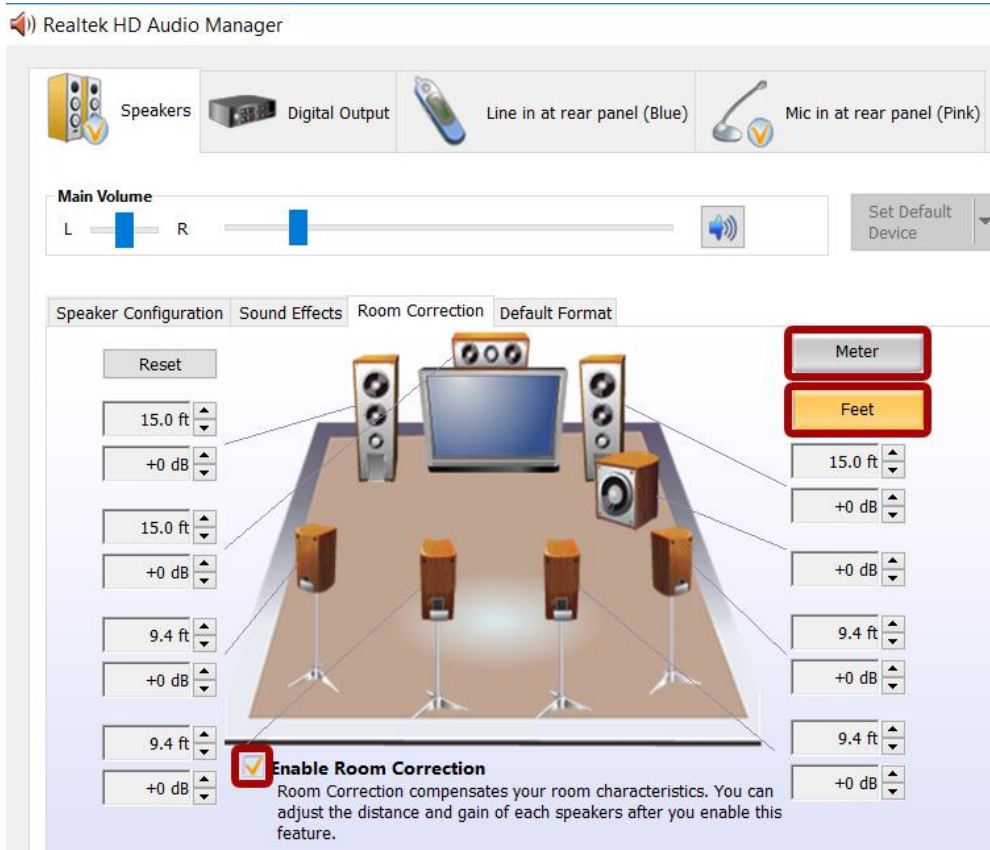

The final Device section covers the microphone. This tab includes both a recording and a playback section.

Both features have similar balance options as the other sections, but differ slightly in the Volume slider function.

The Recording Volume slider pertains to audio recorded by your microphone. Raising the volume allows the audio to be recorded at a higher volume; in other words, if the microphone is used to speak to another person, and the person has a hard time hearing you, raising the volume will make it easier to hear you. Conversely, if you are too loud, lowering the volume slider will produce a quieter audio. Muting this setting will mute all audio recorded by your microphone.

The Playback Volume pertains to a function that allows the Realtek controller to play back any audio the microphone picks up. This is a useful feature to assist with hearing your own speaking volume or audio content playing in the background. By default, this setting is muted. If you encounter an issue where you constantly hear yourself talk, and you're sure it's coming from the computer, check first to see if this setting is enabled.

The Microphone Boost button is next to the upper Mute button. The boost assists by increasing the gain of what your microphone picks up while recording. If your microphone is not consistently picking up your voice when speaking, try adjusting the boost higher in small increments, as a little boost can go a long way.

To increase the boost, click the "Microphone Boost" button. When the slider window pops up, adjust the slider bar to the right, then close the popup by clicking the "X" and retest. Whenever you test a different microphone, reset the Boost to 0, test again, and adjust as necessary. You should keep in mind, however, that some mics naturally record louder than others, and too much gain can ruin a recording. Likewise, if you use your microphone for VOIP applications, too much boost can be painfully loud for whomever is on the other side.

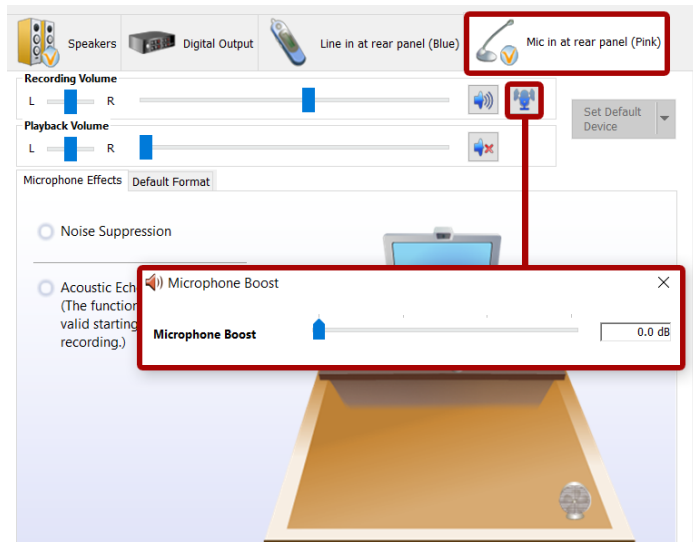



Under “Microphone Effects,” there are two options that may be enabled: “Noise Suppression” and “Acoustic Echo Cancellation.” “Noise Suppression” helps to remove background noises, such as fans, air conditioning, or anything else that causes a consistent ambient sound in the room.

When enabled, “Acoustic Echo Cancellation” removes echoes caused by room acoustics. For example, when you speak into your mic, your mic initially records your voice, but it may also pick up an echo caused by your voice bouncing off objects in your room. This creates an echo audible to whomever you’re speaking to, much like being on a phone call with someone on speaker phone and you hear your own voice coming back into your speaker. In these situations, this setting can prevent this from occurring.

As with any speaker or microphone setting, your audio equipment will have a significant effect on audio quality and effectiveness of multiple settings. For example, some microphones already equip some degree of noise or echo cancellation and do not benefit further from Realtek’s options. Likewise, even for microphones that do not have built-in noise or echo cancellation, Realtek’s cancellation effects may create distortion or other audio problems. You will need to test your own equipment to determine the effectiveness and usefulness of the various settings outlined above in the Realtek HD Audio Manager guide.

EVGA NU Audio

EVGA NU Audio is a second and more powerful audio output available on the EVGA Z490 FTW motherboard. Utilizing the more powerful headphone/speaker amp on the Z490 FTW, NU Audio can drive up to 600ohm headphones, as well as providing the ideal sound for every type of audio experience. The NU Audio application features a user-friendly GUI to easily and quickly adjust settings or use a preset to jump right into the action.

NU Audio is designed to work with 2.0 or 2.1 channel audio, such as headphones or speakers with or without a subwoofer. The headphones/speakers must be connected via an analog audio jack; headphones or speakers that connect via USB will not work with NU Audio. Within the NU audio GUI, you can add virtualization and EQ options by adjusting the settings.

Note: NU Audio is available only as a Stereo output option through the front panel header. 4.0, 5.1, and 7.1 channel audio and stereo audio out of the rear I/O panel is not available through the NU Audio GUI. If you wish to use 4.0, 5.1, 7.1 channel or stereo output via the rear panel I/O, you must use the output ports located on the I/O Panel of the motherboard (Page 13, Component 11) and configure your settings accordingly via the Realtek HD Audio Manager.

Note: While the NU Audio exists separately from the Realtek HD Audio, some system requirements, settings, and features crossover due to shared Windows audio resources. As a result, some changes made in the Realtek HD Audio Manager will have an effect on the audio output through NU Audio.

To use NU Audio:

1. Install the EVGA Z490 FTW motherboard, including the cable to your Front Panel Audio Header (Page 11, component 22)
2. Install the Realtek HD Audio driver, included on the USB Flash drive with your motherboard
3. Install the “NU Audio” driver and launch the NU Audio application
4. Attach your headphones or speakers to the front panel headphone/speaker jack on your case or bay device.
5. Confirm that the Windows Playback default device is set to the Realtek High Definition Audio.

Make sure that the Speaker Configuration in Realtek HD Audio Manager is set to Stereo, or NU Audio will be disabled. When configured properly, the Speaker Configuration will be set to Stereo and the front panel audio jack will be a solid green:

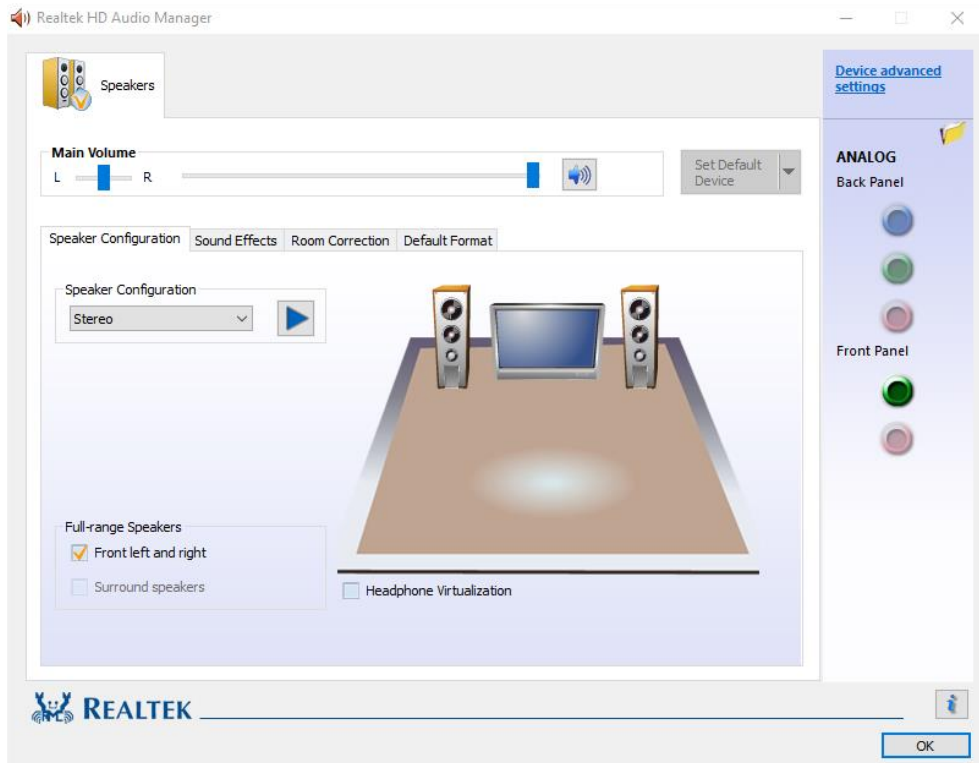

The EVGA NU Audio will detect whether you have speakers/headphones connected to your front panel headphone/speaker jack. If you have another audio device connected to the rear panel jacks, the rear panel device will be disabled. If the audio device is not connected, or connected to the Realtek HD Audio ports, you will see this:



The NU Audio Control Panel

The NU Audio control panel features a number of preset audio functions and a custom preset to allow you to manually adjust each of the NU Audio settings. Although you can use speakers with NU Audio, this guide is written assuming the user is wearing headphones.

To begin, the Control Panel has standard features, such as a volume slider, a mute button, and a settings menu.



The SETTING menu provides several options:

- i. Start With OS
 - a. Select this box to launch NU Audio when Windows starts
- ii. Start Minimized
 - a. Select this box to launch NU Audio minimized to your system tray when Windows starts
- iii. Apply previous settings on load
 - a. Select this box to launch NU Audio using the same settings set when the application was last closed
- iv. Check updates
 - a. Change this option to determine how often NU Audio will check for a new software version

When you first connect your audio device, you will see NU Audio Control Panel initially set to ORIGINAL MODE.

1. ORIGINAL Mode



The Original mode passes through a neutral, unprocessed sound that does not contain any EQ or sound adjustments. This preset is best to evaluate NU Audio directly with source audio material or contrast the sound with any of the other preset options.

2. SURROUND Mode



The Surround mode preset uses a combination of Reverb and Crossfeed to allow positional audio to register around your head. The Crossfeed setting will allow left and right positional audio greater freedom to cross over to the opposite side of the head, while a higher Reverb will increase the audio volume to account for the lower volume that occurs with a higher level of Crossfeed. This has the effect of creating greater immersion within whatever type of entertainment content you choose. This setting works well with a variety of content types, from gaming, movies, and certain types of music.

3. BASS Mode



The Bass mode is designed to give a bit more volume and reverberation to content played on this preset. The extra Reverb will increase the volume and effect of sub-bass frequencies. This setting is generally best for music, although you can increase the effect through the Custom Preset, if you wish.

4. GAMING Mode



The Gaming mode preset consists of a slight bump in Reverb to provide a little more sound amplification and more noticeable positional audio to help locate sounds within a gaming environment. This preset is designed to provide an improved stereo gaming experience. For more impact, you may consider trying the Bass preset.

5. THEATER Mode



The Theater mode preset creates the ideal environment for watching movies or other visual content by expanding the virtual soundstage and increasing the volume and positional effects to compensate. By increasing the Space, the audio output has room for bigger explosions or quiet suspense, while the boost to Reverb makes sure that the effect is noticeable.

6. CUSTOM mode



The Custom mode preset allows you to select each of the settings and determine the correct level for your audio gear. Please note that there are many factors to consider when comparing headphones. In other words, two different pairs of headphones may have significant differences in audio quality or listening experience when using identical custom settings. For example, some headphones naturally produce a wider soundstage or higher level of Bass without any adjustment. We encourage you to test for yourself to see what sounds best with different types of content.

In Custom mode, you will notice that the names of the following settings are clickable, which will enable/disable the audio effect settings. For example, if you want to see how your audio sounds without the Reverb level you set, click the REVERB button to disable it, and the setting will become grayed out.



You can do this with each of the settings. However, Crossfeed and Cross Gain are linked and will be enabled/disabled together.

NU Audio Custom Settings:

a. REVERB

Reverb acts much like an amplifier for the volume. It increases the level of the audio, but it also makes a noticeable impact with positional effects by increasing or decreasing the sound made when objects collide with other objects. Use care when setting Reverb, as this will likely be the most noticeable change to your audio. Setting Reverb too high will likely create an unpleasant volume level, while insufficient Reverb will leave the audio sounding hollow and unnatural.

b. SPACE

Space refers to the soundstage created by the headphones to both spatially identify the distance of the audio from the ear, as well as the virtual effect created to simulate the location of positional objects. This setting is essential to creating a virtual surround environment if adjusted carefully. If the Space is set too high it may be difficult to determine the location of certain sounds or certain details may be lost. Likewise, if the Space is set too low, you may find that too much detail is compressed in the same location, which means it may be difficult to separate distinct audio signatures.

c. CROSSFEED

Crossfeed refers to how much left/right directional audio bleeds into the other ear. For example, if you hear a door slam to the right of your position, the sound will first travel to your right ear and then reach your left ear after a slight delay. This tells your brain where the sound is coming from and how far away the sound originated. Similarly, speakers recreate this effect naturally, for the most part. With headphones, however, sound is not produced in this way because each audio channel is enclosed. Crossfeed remedies this by allowing audio directed towards one channel to bleed into the opposite channel with a slight delay, thus simulating a more natural sound. Carefully adjusting Crossfeed has been known to reduce listening fatigue for some people.

For NU Audio, balancing the Crossfeed will both pass through a more natural audio experience, but it can also improve detection of positional effects from left/right audio.

d. CROSS GAIN

Cross Gain accompanies Crossfeed. Cross Gain is designed to amplify the amount of audio inserted into the opposite channel. Similar to Reverb, raising Cross Gain will increase the volume, but Cross Gain is limited to the delayed audio inserted into the opposite channel. This setting should be considered an option to fine-tune the volume of left/right audio to balance the distance between the drivers and your ears for each channel.

EVGA NU Audio brings a new audio experience to those who often rely on using their front panel audio jack. We encourage you to test out NU Audio and enjoy a more powerful listening experience.

Using the ELEET X1 Software Suite

EVGA ELEET X1 is a monitoring and tuning software designed for EVGA motherboards, which is available on the included USB drive and the EVGA website at <https://www.evga.com/electx1>.

After installation, run ELEET X1. The left-hand side of the display contains system information about your motherboard, including the CPU, per-core CPU clock speed/voltage/temperature, and memory information. This information is displayed in real-time and is available at all times, regardless of which tab is selected.

The first tab is “Overclocking,” which covers adjustments to each Core multiplier, Ring ratio and various voltages, which provides a level of voltage control similar to what is available in the BIOS.

The screenshot displays the EVGA ELEET X1 software interface for the Z490 FTW motherboard. The interface is divided into several sections:

- Top Bar:** EVGA logo on the left, ELEET X1™ logo in the center, and a SETUP icon on the right.
- Navigation Tabs:** CPU, Overclocking (selected), Memory, Monitoring, System, and LED.
- Left Panel (CPU):**
 - Clock:** Multiplier x39 (8 - 39), BCLK 100.00 MHz.
 - Core Info:** Core #00 to #09, each showing 3900.00 MHz | 1.024 V | 33 °C.
 - Memory:** (Currently collapsed)
- Overclocking Section:**
 - Core Ratio:** A horizontal bar chart showing Core #00 to #09 and Ring, all set to x39.
 - Current Limit Throttling:**
 - Vcore Target Voltage: 1.022 (Default) Adaptive
 - Vcore Offset Voltage: 0.000 Override
 - VSA: 1.054 (1.049)
 - VCCIO: 0.948 (0.950)
 - VCCPLL: 1.074 (1.050)
 - VCCPLL_OC: 1.196 (1.200)
- Right Panel:** Profile selection buttons numbered 1 through 9.
- Bottom Bar:** Load, Default, Apply, and Save buttons.
- Version:** v1.0.0.1 in the bottom right corner.

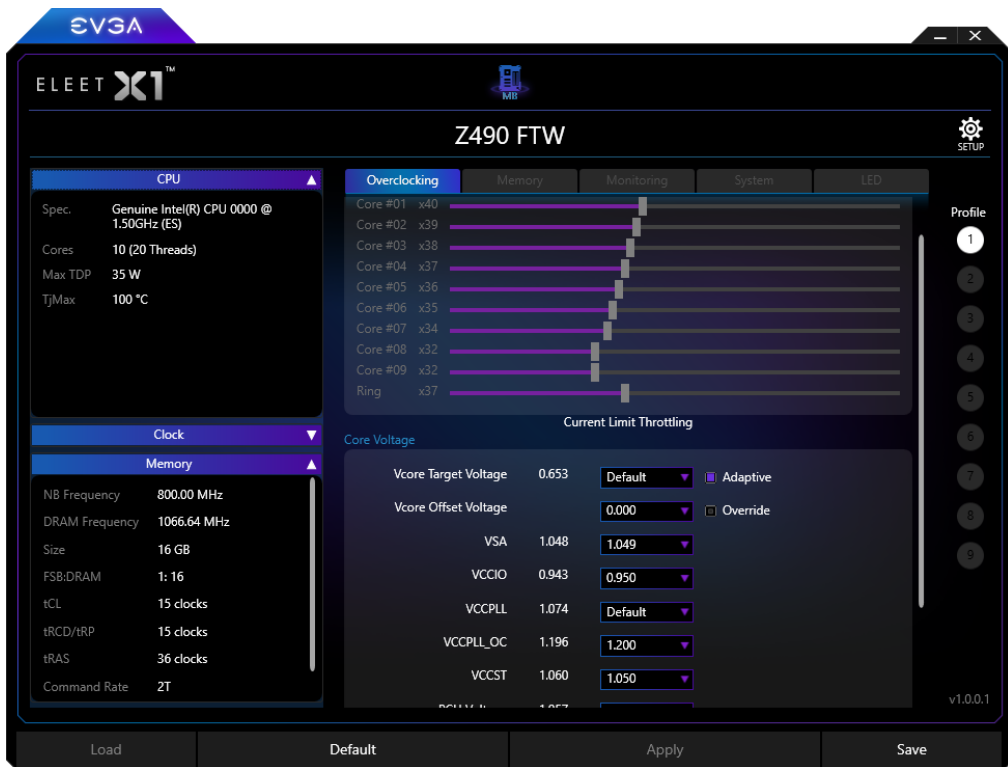

As seen above, there are options for multiple voltages, and two options for your CPU VCore: Adaptive and Override voltages. Adaptive allows for a tighter voltage profile to keep voltage and heat to a minimum, while Override is more of a brute-force method of setting your voltage. One primary advantage of using a stable Adaptive voltage is that it allows your CPU to properly take advantage of C-States and energy saving features, which can extend the lifespan of your CPU.

Adaptive requires you to set both a Target Voltage and an Offset Voltage. Start by setting your Target Voltage, which represents the voltage necessary to run stable (or close to it), even under load. One way to determine this is by stress-testing your CPU with your desired overclock. Offset voltage can then be used to fine-tune additional voltage that may be required under load or stress situations.

Override is simply a static voltage. Outside of extreme benching, this setting is typically not needed or ideal for the longevity of the CPU, since voltages are meant to fluctuate based on load. Alternatively, this can be used in the early stages of overclocking to find your Target voltage, before switching back to Adaptive.



Other voltages do not utilize the Adaptive or Override voltage settings. Instead, these use a pulldown menu to select preset voltages, as shown above. The voltages for these components are set by detection during POST, and ELEET X1 will open the pulldown to the currently detected voltage. Please be careful when adjusting voltages, as there are risks to running electronics out of spec. Although EVGA warranties overlocking, other components are manufactured by different brands (i.e. RAM and CPU), which may have different policies towards overlocking.

When your changes are complete, click “Apply” to accept and apply the new settings, or click “Default” to restore stock settings.

To Save a profile, first configure and apply any and all settings. Next, click on any of the profiles on the right side of the screen. Saved profiles show a ring around the profile, while empty profiles have no outline. When you click on one of the profiles, it will be filled in. If you have previously saved a profile here, click “Load” to apply your profile. Once loaded, you may close ELEET X1 and continue to use the new settings.

The “Memory” tab allows for Real Time Memory overclocking on the Z490 FTW, although this function is limited and determined by the installed processor. In other words, not all processors will be able to adjust memory timings on this page. Memory timing adjustments may still be made in the BIOS.



The next tab is “Monitoring,” which contains real-time system information of voltages, temperatures, and fan speed information. Please note that all readings on this page are pulled from motherboard sensors, and change dynamically. Temperatures and voltages are measured at fixed intervals, which can often make the readings appear to jump back and forth. Furthermore, voltages on modern motherboards often closely respond to changes in load, meaning that voltage readings will change based on load and usage, which is normal.



The Monitoring page only supports a static readout of each voltage, temperature, and fan speed. Settings cannot be adjusted or manipulated on this page.

The “System” tab provides more detailed information on the motherboard, CPU, and memory. Here, you can find the motherboard specs and BIOS date and version.

EVGA ELEET X1™ Z490 FTW

CPU

Multiplier x39 (8 - 39)
 BCLK 100.02 MHz

Core #0 3900.94 MHz, 1.018 V, 36 °C
 Core #1 3900.94 MHz, 1.018 V, 37 °C
 Core #2 3900.94 MHz, 1.018 V, 35 °C
 Core #3 3900.94 MHz, 1.018 V, 36 °C
 Core #4 3900.94 MHz, 1.018 V, 36 °C
 Core #5 3900.94 MHz, 1.018 V, 35 °C
 Core #6 3900.94 MHz, 1.018 V, 35 °C
 Core #7 3900.94 MHz, 1.018 V, 34 °C
 Core #8 3900.94 MHz, 1.018 V, 35 °C
 Core #9 3900.94 MHz, 1.018 V, 35 °C

Mainboard

Manufacturer EVGA Corp.
 Model Z490 FTW (1.0)
 Chipset Intel Comet Lake (Rev. 04)
 Southbridge Intel Z490 (Rev. 00)
 Brand American Megatrends Inc.
 BIOS Version 0.04
 Date 03/16/2020
 Graphic Interface Version PCI-Express
 Transfer Rate x16
 Max. Supported x16

CPU

Name Intel Core i9-10900K
 Code Name Comet Lake
 Package Socket 1200 LGA
 Technology 14 nm
 Family 6
 Model 5
 Stepping 4

v1.0.0.1

Load Default Apply Save

Additional CPU details are provided, including the Stepping, Revision, Instructions, and Cache layout.

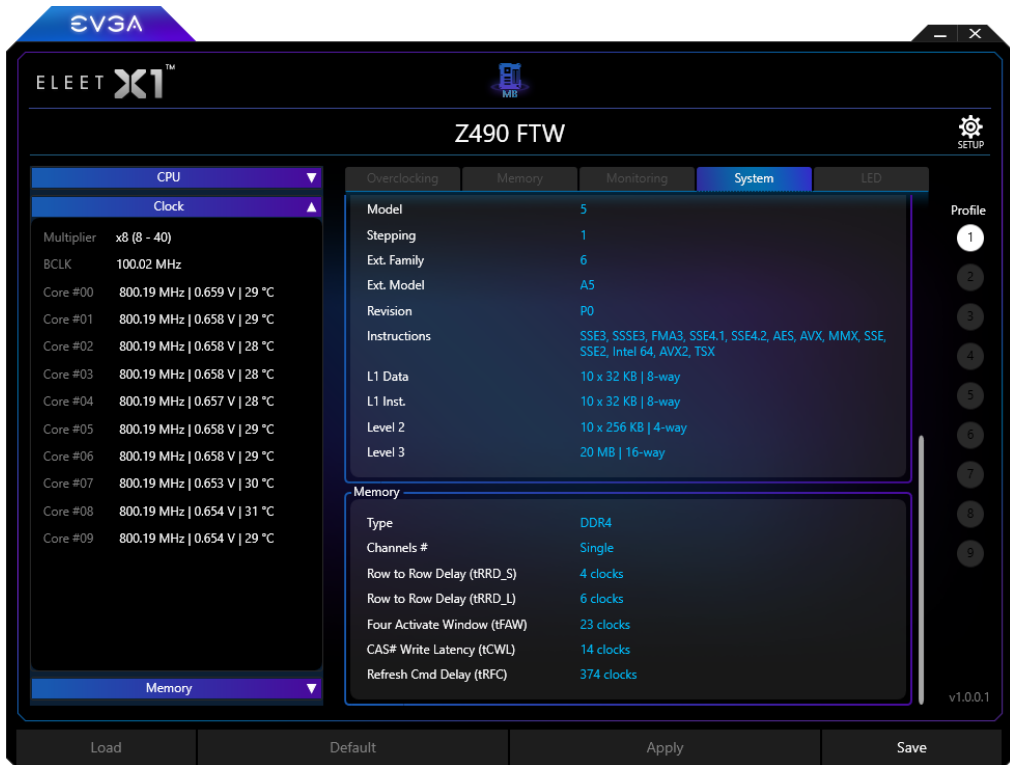

Lastly, additional memory information is available for secondary memory timings, as well as the type and number of channels being used.

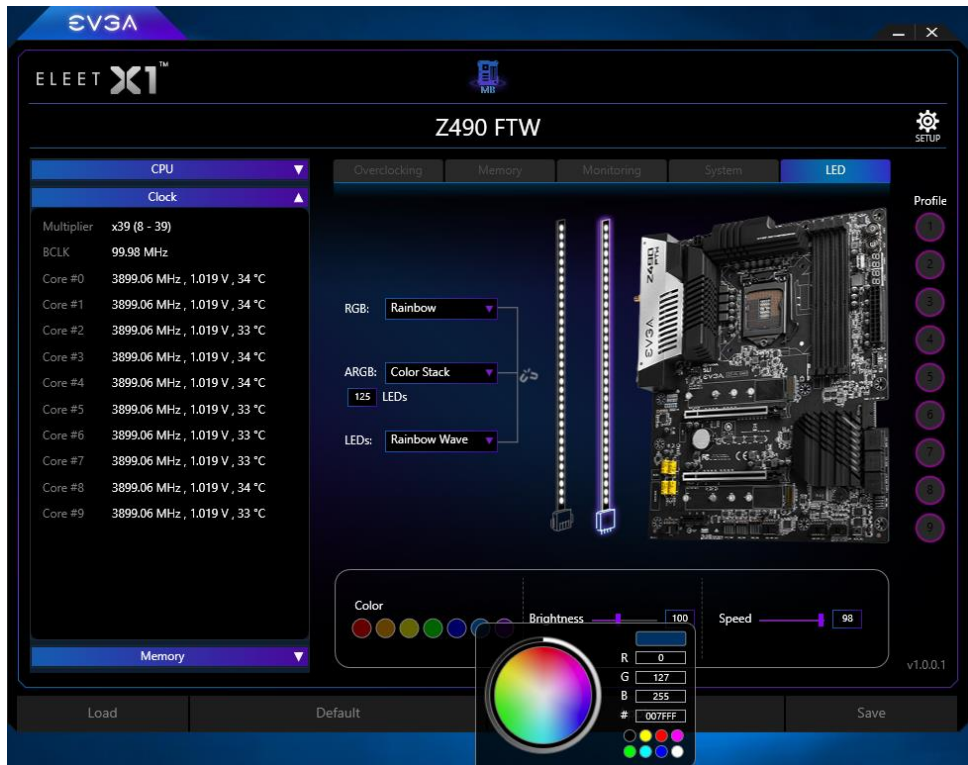

Onboard ARGB and ARGB/RGB headers connected to the motherboard can be controlled through the LED tab. Users can select different modes/patterns of lighting based on the header type and the number of LEDs connected through the ARGB header. The LED lighting can be synched together by enabling the “link” button located to the right of the ARGB drop-down box. In the lower box, you can adjust the color of the LED light, as well as the brightness and speed of the LED lighting.

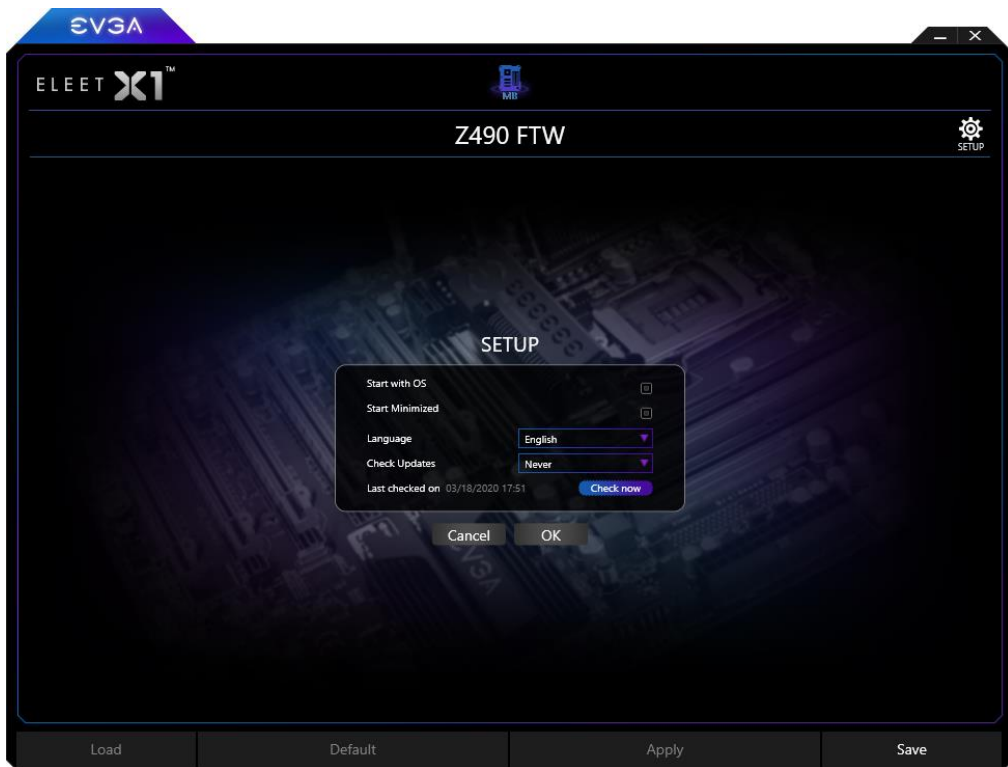

The Setup menu gives you control over basic program and OS startup behavior, along with the ability to check for new updates.

This has been the ELEET X1 utility overview, which should give you a solid start to understanding and using the ELEET X1 software suite.

*EVGA ELEET X1 is still undergoing final testing and design modifications at the time of this manual's printing. Final GUI design, menus, and functionality may be subject to change.

Installing Drivers and Software

Note: It is important to remember that before installing the drivers included in the kit, you must first load or install your operating system. The motherboard natively supports 64bit versions of Windows 10.





The kit comes with a USB flash drive that contains utilities, drivers, and additional software.

The USB flash drive that has been shipped with the EVGA Z490 FTW Motherboard contains the following software and drivers:

- Chipset Drivers
- Audio Drivers
- EVGA NU Audio Drivers
- RAID Drivers
- LAN Drivers
- ME Drivers
- Intel HD Graphics Drivers
- EVGA ELEET X1
- User's Manual

Windows 10 Driver Installation

1. Insert the USB flash drive included in your EVGA Z490 FTW motherboard kit into a USB port on your case or a USB port on the motherboard's rear I/O panel.
2. Double-click the "Autorun" application file.

| | | | |
|---|-------------------|-----------------------|----------|
|  autorun.cdd | 1/5/2018 9:17 AM | CDD File | 492 KB |
|  autorun | 1/5/2018 9:17 AM | Application | 6,284 KB |
|  autorun | 9/25/2017 3:10 PM | ICO File | 9 KB |
|  autorun | 1/5/2018 9:17 AM | Setup Information | 1 KB |
|  autorun | 1/5/2018 9:07 AM | Configuration sett... | 2 KB |

- The EVGA Driver Utility Screen will appear.



- EVGA strongly recommends that you install the motherboard drivers first, followed by rebooting your system. Next, install the Intel Rapid Storage drivers and reboot.
- The Driver Utility Screen also contains helpful links to give you more information about your new EVGA motherboard and additional resources to get started. The Z490 FTW manual is available through this utility and within the USB flash drive directly.
- EVGA also encourages you to register your motherboard online by either clicking on the Online Registration button in the Driver Utility, or by visiting <https://www.evga.com/register>.

Warranty and Overclocking

EVGA's motherboard and graphics card components are designed for and intended for enthusiasts. To be perfectly clear, overclocking will **NOT VOID** your warranty. This means that you are free to do any type or level of overclocking you like, including traditional means, such as by using the BIOS/UEFI (for motherboards); software overclocking with EVGA utilities, such as PX1 or ELEET X1; or even third-party software utilities. If the motherboard or card fails due to overclocking, you're covered.

Likewise, EVGA understands that enthusiasts are not always satisfied with the provided stock cooling options. Replacing heatsinks, fans, or thermal grease will **NOT VOID** your warranty. Want to install a waterblock on your new motherboard or graphics card? No problem. Planning on a long benching session with a DICE/LN2 pot? Good luck on the benching, but your warranty will still be intact after you've set new world records.

Of course, there are some limitations to our warranties. If an EVGA motherboard or graphics card sustains physical (i.e. damage to the PCB or component due to slippage with a hand tool) or liquid damage, the warranty is void. Similarly, permanent changes to components or the PCB will void your warranty, including the removal of pre-attached components soldered to the board, or the addition of components that are not removable without heat or solvents. In other words, you may use Precision XOC to raise the voltage on your graphics card while overclocking, but you may not solder on another power connector as an alternative.

If the product fails within the warranty period, you must return the product to its original configuration. This means ALL original heatsinks and fans must be reattached as they were when it was first shipped. Even if the product no longer works, it must be returned to its original state before sending it in. If you no longer have the original heatsinks you may be charged for the missing parts.

The EVGA warranty covers overclocking ONLY to EVGA products; EVGA is NOT responsible for damage caused to components manufactured by other companies. Before overclocking your system, check with the manufacturer of your other components to ensure that you will not void the warranty on those parts due to overclocking. Due to the uniqueness of every system, EVGA Customer Support cannot assist you with overclocking. For overclocking assistance, please visit our Community Forums at <https://forums.evga.com>

Troubleshooting

Flashing the BIOS

The motherboard BIOS of your Z490 FTW will sometimes need to be updated to correct bugs, improve performance, and sometimes add features. The latest motherboard BIOS can be found at <https://www.evga.com/drivers>. Select the Motherboard tab, select the Z490 Chipset, 122-CL-E497 for the motherboard, and select BIOS to see the most recent BIOS versions.

You may update the motherboard BIOS in several ways, as we provide a method to flash via Windows, update via USB from within the BIOS, or update using the force method described below in the section, “Flashing the BIOS Without a CPU”.

For ease of use, you may use the included USB flash drive provided with your motherboard kit. If you use a different USB flash drive, please make sure to properly format the flash drive to FAT32 before trying to flash the BIOS.

A. To flash via Windows:

- a. Download the latest motherboard BIOS from the EVGA Download page, linked above.
- b. Unzip the downloaded file to your desktop.
- c. Make sure to close all open software and applications.
- d. Open the folder and double-click the “Update.bat” file.
- e. The flash utility will begin. If prompted, type “Y” to begin the flash.
- f. DO NOT TURN OFF THE MOTHERBOARD UNTIL THE FLASH IS COMPLETE.
- g. When complete, the motherboard will automatically shut down. Power on the motherboard to go into the motherboard BIOS.
- h. When you see the Z490 FTW splash screen, quickly tap the Delete key to enter the BIOS. Confirm that the BIOS has been updated to the latest version by checking the BIOS version (located in the bottom-right of the screen) with the BIOS version you downloaded.

Note: If the flash box immediately closes after running Update.bat, you may need to run Update.bat from a command prompt with administrator privileges, or right-click Update.bat and select “Run as administrator”.

B. To flash from within the Z490 FTW BIOS:

- a. Download the latest motherboard BIOS, and unzip the file to your desktop.
- b. Drag the unzipped folder into your USB flash drive.
- c. Reboot the motherboard. When the Z490 FTW splash screen appears, tap the Delete key to enter the BIOS.
- d. Once inside the BIOS, navigate to the EXTRAS tab, and select BIOS Update:
- e. Navigate to the folder containing the BIOS files. Select the correct .bin file from the dropdown list.
- f. After selecting the file, confirm that you wish to update the motherboard BIOS.
- g. After confirming the download, you'll see an indication that the BIOS is updating.

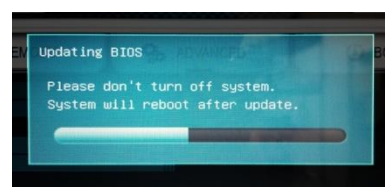

DO NOT POWER OFF THE MOTHERBOARD WHILE THE BIOS IS UPDATING.

- h. Once the update is finished, the motherboard will power off. Power on the motherboard and enter the BIOS, using the method described above. It is normal to see an error message after updating your BIOS such as the one below:
- i. Confirm that the BIOS has been updated to the latest version by checking the BIOS version (located in the bottom-right of the screen) with the BIOS version you downloaded.





Note: Your USB flash drive must be formatted as FAT32, or this method of flashing the BIOS will not work. The USB flash drive included with your motherboard is already properly formatted to FAT32. If you plan to use your own USB flash drive, however, please make sure the file system is correct before attempting this method.

C. To flash from power on state:

A third method of flashing the BIOS can be done without going into the BIOS or from within Windows. The steps for flashing directly from power on are located below, in the “Flashing the BIOS Without a CPU” section. These steps will explain how to prepare the USB flash drive included with your Z490 FTW motherboard to update with a newer BIOS using the method below.

- a. Plug in the USB flash drive included with your Z490 FTW motherboard, and boot into Windows.
- b. Navigate to the USB flash drive so you can view the installed folders. In the root of the flash drive, you should notice a file named “EVGAE497” or “EVGAE497.bin”. We highly recommend that you make a backup of this file, in case you discover an issue with the new BIOS or are unable to boot after flashing the new BIOS.

 autorun.exe

 autorun.ico

 autorun.inf

 autorun.ini

 EVGAE497.bin

 lua5.1.dll

 lua51.dll

- c. Download the latest BIOS for the Z490 FTW from <https://www.evga.com/drivers>, and unzip the file to your desktop.
- d. Inside the folder will also be a .bin file with the name of the new BIOS. Right-click the .bin file and select “Rename”. Change the name to “EVGAE497.bin”.
- e. Replace the existing EVGAE497.bin file in the EVGA USB flash drive with the new BIOS that you downloaded and renamed.
- f. At this point, you are ready to begin the BIOS update. Follow the steps in the “Flashing the BIOS Without a CPU” in the section below.

Flashing the BIOS Without a CPU



If your motherboard cannot boot, or you are unable to see picture on your display, there can be a number of potential causes preventing your motherboard from completing a successful boot. Some of these are listed and explained below.

If other troubleshooting does not resolve your issue, or you've purchased this motherboard with a BIOS version prior to official support for your compatible Intel® CPU, you may need to flash the BIOS.

Note: Before you begin, make sure that your USB flash drive is formatted as FAT32, or this method of flashing the BIOS will not work, as noted above.

If you plan to use the included USB flash drive with the latest BIOS version from the EVGA Website, please make sure to first follow the steps listed above for the "To flash from power on state" section to prepare the flash drive. Once the latest BIOS is placed in the root folder and renamed EVGAE497.bin, you are ready to proceed with the BIOS update.

In order to flash the BIOS without picture, you must follow these steps:

1. Turn off your Z490 FTW motherboard, if on, and turn your power supply off by flipping the switch to the "Off" position.
2. Plug in the included USB flash drive to the USB 2.0 to SPI header, as noted in the component legend on Page 11, component 20, or refer to this image: 
3. Make sure the 24pin power connector from your power supply is plugged in to the motherboard.
4. When ready, flip your power supply switch to the "On" position and hold down the reset key. 
5. Continue holding down the reset key, as the POST LED counts down from 4.
6. When the flash begins, release the reset key. The POST LED will cycle in a clockwise manner during the flash process.

DO NOT TURN OFF THE MOTHERBOARD. IF THE MOTHERBOARD IS TURNED OFF PRIOR TO COMPLETING THE FLASH PROCESS, THE BIOS MAY BECOME IRREVERSIBLY DAMAGED.

7. The flash process may take approximately 4 minutes. When finished, the motherboard will automatically reboot. If you have not installed a CPU and at least one 8-pin CPU power connector, the POST LED will stop at C. If this occurs, turn off the motherboard and power supply and install any remaining hardware components before attempting to boot again.

SSD / HDD is not detected

It is important to note that, as with *ALL* storage devices, if there is a connectivity issue, make sure it is enabled in BIOS. Likewise, if there is a device that shares bandwidth with your SSD or HDD (Page 23), make sure that the desired device is enabled in BIOS, or all other troubleshooting that comes after this section is moot.

If you've physically installed a drive that is not detected in Windows, by Windows setup, or within BIOS, please take the following steps. Component troubleshooting is primarily accomplished through process of elimination testing to deduce a faulty component or a bad connection.

Device is not receiving power:

For devices with external power - such as SATA - make sure power is connected to the drive, and that the other side of the cable is attached to the correct port on your PSU. If you are using a mechanical drive (either a platter HDD or an optical drive) you should hear the motor spin up when you first power on the system. Similarly, if you put your hand on the device you should feel the drive spin up, warmth from the motor, and a light on the front from an optical drive. If you see, hear, and feel this, then the device is receiving power, and you may skip to the next section. If you do not see, hear, or feel this, first try the cable on a device that you know works; if the cable works, then the issue is the device in question.

However, if you replace the device and the issue persists, then it is either the PSU, one of its modular cables or the port the cable is plugged into. If you are using a modular cable, try a different cable in the same PSU port, and also test on a different port to isolate the source of the problem. In many cases, the PSU manufacturer may be able to replace the cable if it is bad.

Device has power, but does not show up in the BIOS:

If the device is getting power, then we should expect to see the drive in BIOS. If the drive does not show in the SATA Configuration screen in BIOS, make sure the SATA cable is firmly seated on both the drive side and the motherboard. As noted above, if

you are using a device on a connector that shares its bandwidth, you will need to check and/or change the BIOS setting related to your device.

If you've already done this, test a different device using the same cable and SATA port to see if the issue persists. If the issue is not resolved, test a different SATA cable, or a different SATA port. Always be sure to test each step separately, otherwise, if several aspects are changed and drives are now detected, then you will not know what change actually fixed it. If other devices work on the ports and with the same cables, then the issue is the device in question. If testing shows that either one or more of the ports are bad with a different device, then the motherboard is likely the issue. If one or more of the cables test bad with a different device, then replacing the cable(s) should resolve the issue.

M.2 devices have a bit less to test due to their connection that provides data and power through a single socket. M.2 devices are installed at an angle, gently pushed down flush with the motherboard, and then screwed into place. M.2 drives only fit one way, and cannot fit upside-down; however, you can have a bad connection if the card is not pushed all the way into the slot before bolting it down. Please refer to Page 24 for M.2 hardware installation, and Page 52 for setup.

Device has power, is seen in BIOS, but cannot be found in Windows:

Lastly, if the device was just added, other troubleshooting in this section has been done, the device has power and shows up in the BIOS, but is not seen in Windows, then it may be that the drive needs to be initialized, partitioned, and formatted in Windows. See Page 85 for instructions.

System does not POST, and POST code indicator reads “C”

When the system powers on, the POST code indicator should cycle through several different codes before booting. However, if the boot process does not complete, you should look at the LED indicator, as it will give you diagnostic information. When a POST code indicator cycles through codes and stops at a specific code, this is an indication that initialization of a specific component or process on the board failed. If you power on the board and it goes directly to “C,” and nothing else, that is an indication of a CPU-related issue. If the board cannot detect the CPU in the socket, the POST code display will display a “C”, as well. It is not likely a faulty CPU, although it is possible; instead, it is most likely a CPU power issue. Above the CPU socket, there is one 8-pin power connector (as shown in the image to the right). This connector is the main power for the CPU, and without power from the PSU the system cannot fully power on and initialize.

Make sure the plug is fully-seated and also make sure that the tab on the socket and the release on the power connector are on the same side. If the connectors do not line up, then you have plugged in a PCIe 8-pin into the EPS connector, which may cause irreparable damage to the motherboard or the CPU.

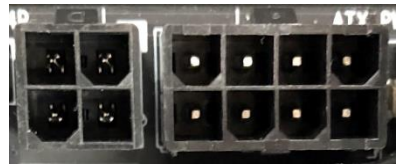

If the PSU is modular, make sure the cable is fully-seated on the PSU side as well. Also, only use cables from your PSU manufacturer for your specific PSU, because using a cable designed for a different PSU may have catastrophic effects. Finally, ensure that the cable on the PSU side is plugged into the connector for the CPU, typically labelled “CPU” or “EPS,” but consult your power supply manual for the correct plug.

The Z490 FTW also features a 4-pin ATX power connector. This connector is provided as an optional connection to provide supplemental power, but should not be used as the main power source for the CPU. If you are unable to POST, make sure that you have first plugged in the 8-pin EPS connector.

System does not POST, and POST code indicator reads “55”

A POST code error reading “55” indicates a memory issue. Verify that memory is installed, and that it is properly seated. Make sure that the memory is on the official support list at <https://www.evga.com/support/motherboard> and click on “EVGA Z490 FTW.” If the memory is not on the list, it may still work because EVGA is unable to test every memory kit released. However, this motherboard will not support modules over 32GB or ECC/Registered RAM.

If your memory should work on this motherboard, the next step is to bring it down to one stick of memory in “DIMM slot 2” and retest. If this is your first boot with the motherboard and the board will not POST, your next step is to press the “Reset CMOS” button. The system will power on when the Reset CMOS button is pressed, which is normal. This should allow the system to boot up. When you see the EVGA Z490 FTW screen, press “Del” to enter BIOS, set the XMP (instructions are covered in first boot section on Page 50), press F10 to save and exit, which will reboot the system. If the system reboots successfully, you can power down and install the rest of the memory to retest.

System does not POST, and POST code indicator reads “d7”

If the motherboard cannot detect a Keyboard, the system will fail to POST with a “d7” POST code. When this happens, some video card / monitor setups will display a message on screen about a Keyboard error, while others will just remain blank. If this happens, power down the system and reseal the USB connector. Make sure the Keyboard is only plugged in to either a PS/2 port or USB3.2 Gen1 slot. This error can sometimes happen with older wireless keyboards, as well. If this is the case, we recommend that you plug in a regular USB keyboard, reboot, enter BIOS, and go to Advanced – USB Configuration. Make sure “Legacy USB Support” is set to “enabled,” then press F10 to save and exit. Your keyboard should now work, and the board should POST past “d7.”

Have a question not covered above, or want some online resources?

If you have any issues or questions, you can find a lot of valuable help and information on our website, including contact information for our top-notch Technical Support/Customer Service.

- You may find all of the motherboard drivers at <https://www.evga.com/support/download/>. Select the “Motherboard” tab, then select “Intel® Z490” from the Family tab, then “122-CL-E497” from the part number pulldown. Next, select either “All” or the specific component that requires a driver, then select your operating system and click “Submit”
- You may find the list of officially supported CPUs and System RAM for your motherboard, including the minimum required BIOS revision for compatibility, at: <https://www.evga.com/support/motherboard/>. BIOS updates are cumulative, so they will always support products from the previous version, except when specified otherwise.
- For our Frequently Asked Questions (FAQ) database, go to: <https://www.evga.com/support/knowledgebase/>
- To visit our Community Forums, go to: <https://forums.evga.com/>
- For our Community Forums section dedicated to Z490 motherboards, go to: <https://forums.evga.com/EVGA-Z490-Series-f112.aspx>
- Just finished building or upgrading your system and want to show it off? Make a ModsRigs Profile here: <http://www.modsrigs.com/> and create a page dedicated entirely to YOUR system!
- Still building your rig? Make a build log here: <https://forums.evga.com/EVGA-MODS-RIGS-f33.aspx>

Multifunction LED Indicator

The EVGA Z490 FTW board is equipped with a versatile display to allow real-time monitoring of system status during and after the BIOS POST process. The operating mode can be configured in the BIOS Setup in the Advanced menu, and then H/W Monitor Configuration. The Debut Port Display setting selects the OS display mode. There are multiple modes available:

- ❑ [Temp.] CPU – displays external CPU die temperature sensor readout in real-time. Use this mode to read negative temperatures.
- ❑ [Temp.] PWM – displays VRM temperature sensor readout in real-time after BIOS POST completion.
- ❑ [Temp.] SYS – displays motherboard bay temperature sensors.
- ❑ [Temp.] M.2 KEY-M(1) – displays M.2 KEY-M(1) temperature sensors.
- ❑ [Temp.] M.2 KEY-M(2) – displays M.2 KEY-M(2) temperature sensors.
- ❑ [Temp.] PCH – displays PCH temperature sensors.
- ❑ [Volt.] VCore – displays CPU VCORE after BIOS POST completion.
- ❑ [Volt.] Memory – displays DIMM voltage for slots (0/1/2) after BIOS POST completion.
- ❑ [Volt.] VSA – displays System Agent CPU voltage after BIOS POST completion.
- ❑ [Volt.] VCCIO Voltage – displays I/O voltage after BIOS POST completion.
- ❑ [Volt.] VCCST – displays PCH PLL voltage after BIOS POST completion.
- ❑ [Volt.] VCCPLL – displays analog VCC voltage for internal clock PLL after BIOS POST completion.
- ❑ [Volt.] VCCPLL_OC – displays analog VCC voltage for internal clock PLL after BIOS POST completion.
- ❑ POST Code – displays only BIOS POST completion.
- ❑ Turn Off - completely deactivates 80Port LED display

The Debug Port Display menu the BIOS Setup allows you to pick specific sensors to be displayed on the 80Port.

These temperatures and voltages can also be seen in the BIOS setup window in real-time, for a quick overview.

The recommended settings to display during overclocking are “[Volt.] VCore” and “[Temp.] CPU”

EVGA BIOS - Advanced Tab

System Information:
 CPU TEMP: 31°C | CPU VCore: 0.823 V
 FREQUENCY: 2133 MHz | TOTAL SIZE: 4 GB | VOLTAGE: 1.180 V
 CPU CLOCK: 2.80 GHz | HT | CPU RATIO x BCLK: [28 x 100.0]

Advanced Settings:

| | | | | | |
|---------|------|--------------|------|---------|------|
| CPU Die | 32 C | SYS | 24 C | PCH | 24 C |
| CPU | 31 C | M.2 KEY-M(1) | 25 C | VGA PE1 | 35 C |
| PWM | 34 C | M.2 KEY-M(2) | 25 C | VGA PE2 | N/A |

Fan Settings:

| | | |
|--------------------|----------|----------------------|
| CPU_FAN1 Speed | N/A | [Temp.] CPU |
| Smart Fan Settings | | [Temp.] PWM |
| CPU_FAN2 Speed | 1021 RPM | [Temp.] SYS |
| Smart Fan Settings | | [Temp.] M.2 KEY-M(1) |
| CHA_FAN Speed | N/A | [Temp.] M.2 KEY-M(2) |
| Smart Fan Settings | | [Temp.] PCH |
| SYS_FAN1 Speed | N/A | [Volt.] VCore |
| Smart Fan Settings | | [Volt.] Memory |
| PWR_FAN Speed | N/A | [Volt.] VCCIO |
| Smart Fan Settings | | [Volt.] VSA |
| AUX_FAN Speed | N/A | [Volt.] VSA |
| Smart Fan Settings | | [Volt.] VSA |
| SYS_FAN2 Speed | N/A | SMART |
| Smart Fan Settings | | SMART |

CHA_FAN Mode: Auto

Debug Port: Normal, [Temp.] CPU

Legend:
 F1 : General Help
 F5 : Optimized Defaults
 F7/8 : Save/Load Profile
 F9 : Last Saved Settings
 F10 : Save & Exit Setup
 ESC/Right Click : Exit

EVGA BIOS - Advanced Tab

System Information:
 CPU TEMP: 31°C | CPU VCore: 0.825 V
 FREQUENCY: 2133 MHz | TOTAL SIZE: 4 GB | VOLTAGE: 1.180 V
 CPU CLOCK: 2.80 GHz | HT | CPU RATIO x BCLK: [28 x 100.0]

Advanced Settings:

| | | | | | |
|---------|------|--------------|------|---------|------|
| CPU Die | 31 C | SYS | 24 C | PCH | 24 C |
| CPU | 33 C | M.2 KEY-M(1) | 25 C | VGA PE1 | 35 C |
| PWM | 34 C | M.2 KEY-M(2) | 25 C | VGA PE2 | N/A |

Fan Settings:

| | | |
|--------------------|----------|-------------------|
| CPU_FAN1 Speed | N/A | [Temp.] PCH |
| Smart Fan Settings | | [Volt.] VCore |
| CPU_FAN2 Speed | 1028 RPM | [Volt.] Memory |
| Smart Fan Settings | | [Volt.] VCCIO |
| CHA_FAN Speed | N/A | [Volt.] VSA |
| Smart Fan Settings | | [Volt.] VCCST |
| SYS_FAN1 Speed | N/A | [Volt.] VCCPLL |
| Smart Fan Settings | | [Volt.] VCCPLL_OC |
| PWR_FAN Speed | N/A | POST Code |
| Smart Fan Settings | | POST Code |
| AUX_FAN Speed | N/A | Turn Off |
| Smart Fan Settings | | Turn Off |
| SYS_FAN2 Speed | N/A | SMART |
| Smart Fan Settings | | SMART |

CHA_FAN Mode: Auto

Debug Port: Normal, [Temp.] CPU

Legend:
 F1 : General Help
 F5 : Optimized Defaults
 F7/8 : Save/Load Profile
 F9 : Last Saved Settings
 F10 : Save & Exit Setup
 ESC/Right Click : Exit

POST Beep codes

POST beeps are used in conjunction with the POST Code indicator to help determine the root cause when your system fails to boot. However, modern UEFI/BIOS motherboards also use the speaker to convey helpful information, such as USB device detection. As a result, users may become confused about the number of beeps emitted, making the POST code beep - while still helpful - not as useful as it once was.

| Beep Codes | |
|------------|---|
| # of Beeps | Description |
| 1 | Invalid Password |
| 4 | Some of the Architectural Protocols are not Available |
| 5 | No Console Output Device detected |
| 5 | No Console Input Device detected |
| 6 | Flash Update Failed |
| 7 | Reset Protocol is not available |
| 8 | Platform PCI resource requirements cannot be met |

Many motherboards will beep 1-2 times per USB device plugged in at boot; some will beep more based on functions of the device. These detection beeps may occur at the same time as the system's POST beeps, sometimes making it a challenge to separate the POST beeps from the USB initialization. Since the POST code indicator now fills most of the role previously held by audible beeps, there are far fewer POST beeps to help debug problems, compared to previous motherboard generations.

1 Beep: This relates to BIOS boot passwords. The BIOS will beep, indicating that a password is required to boot. If you incorrectly enter your BIOS password when prompted by the BIOS, you will receive one beep.

4 Beeps: This is an error relating to some small recovery errors, which can occur when coming out of sleep/hibernate.

5 Beeps: This error is stating it cannot detect a keyboard. This can also indicate a video card is not detected.

6 Beeps: This relates to either a failed BIOS update, or a failed Intel® ME Firmware update.

7 Beeps: This relates to a failed CPU INIT request. EFI/UEFI Reset protocol is used when a processor INIT call is used and was not successful. This returns either an “EFI_UNSUPPORTED” error if the INIT type is not supported or an “EFI_Device_Error” if the error occurs while generating the INIT; either will result in seven (7) POST beeps.

8 Beeps: Error given when an incompatible PCI Express device is installed and cannot initialize properly.

POST Port Debug LED

Provides two-digit diagnostic POST codes that shows system boot status and can also show why the system may be failing to boot. The LED is extremely useful during troubleshooting situations.

This Debug LED will display a series of hexadecimal (0-F) codes during the POST and will display current CPU socket temperatures after the system has fully booted into the Operating System. See the “POST CODE” section below for more detailed descriptions of specific POST Codes.



Debug LED with CPU
Temperature Monitor

POST Codes

This section provides the AMI POST Codes for the EVGA Z490 FTW Motherboard during system boot up. The POST Codes are displayed on the Debug LED readout located directly on the motherboard.



Debug LED with CPU Temperature Monitor

See Page 11 and 12, component 19 of the Component Legend for physical location.

This Debug LED will switch to display the user's 80Port Configuration settings after POST (see Page 151). Please note that if you see the Debug LED constantly switching numbers after entering Windows, the Debug LED is showing temperature or voltage information, and is NOT reporting errors.

AMI POST Codes

| | |
|-------|--|
| 1 | Power on. Reset type detection (soft/hard). |
| 2 | AP initialization before microcode loading |
| 3 | North Bridge initialization before microcode loading |
| 4 | South Bridge initialization before microcode loading |
| 5 | OEM initialization before microcode loading |
| 6 | Microcode loading |
| 7 | AP initialization after microcode loading |
| 8 | North Bridge initialization after microcode loading |
| 9 | South Bridge initialization after microcode loading |
| 0A | OEM initialization after microcode loading |
| 0B | Cache initialization |
| 0C-0D | Reserved for future AMI SEC error codes |
| 0E | Microcode not found |

| | |
|-------|--|
| 0F | Microcode not loaded |
| 10 | PEI Core is started |
| 11-14 | Pre-memory CPU initialization is started |
| 15-18 | Pre-memory North Bridge initialization is started |
| 19-1C | Pre-memory South Bridge initialization is started |
| 1D-2A | OEM pre-memory initialization codes |
| 2B | Memory initialization. Serial Presence Detect (SPD) data reading |
| 2C | Memory initialization. Memory presence detection |
| 2D | Memory initialization. Programming memory timing information |
| 2E | Memory initialization. Configuring memory |
| 2F | Memory initialization (other). |
| 30 | Reserved for ASL (see ASL Status Codes section below) |
| 31 | Memory Installed |
| 32 | CPU post-memory initialization is started |
| 33 | CPU post-memory initialization. Cache initialization |
| 34 | CPU post-memory initialization. Application Processor(s) (AP) initialization |
| 35 | CPU post-memory initialization. Boot Strap Processor (BSP) selection |
| 36 | CPU post-memory initialization. System Management Mode (SMM) initialization |
| 37-3A | Post-Memory North Bridge initialization is started |
| 3B-3E | Post-Memory South Bridge initialization is started |
| 3F-4E | OEM post memory initialization codes |
| 4F | DXE IPL is started |
| 50 | Memory initialization error. Invalid memory type or incompatible memory speed |
| 51 | Memory initialization error. SPD reading has failed |
| 52 | Memory initialization error. Invalid memory size or memory modules do not match. |
| 53 | Memory initialization error. No usable memory detected |
| 54 | Unspecified memory initialization error. |
| 55 | Memory not installed |
| 56 | Invalid CPU type or Speed |
| 57 | CPU mismatch |
| 58 | CPU self-test failed or possible CPU cache error |
| 59 | CPU micro-code is not found or micro-code update is failed |
| 5A | Internal CPU error |

| | |
|-------|--|
| 5B | reset PPI is not available |
| 5C-5F | Reserved for future AML error codes |
| E0 | S3 Resume is started (S3 Resume PPI is called by the DXE IPL) |
| E1 | S3 Boot Script execution |
| E2 | Video repost |
| E3 | OS S3 wake vector call |
| E4-E7 | Reserved for future AML progress codes |
| E8-EB | S3 Resume Failed |
| EC-EF | Reserved for future AML error codes |
| F0 | Recovery condition triggered by firmware (Auto recovery) |
| F1 | Recovery condition triggered by user (Forced recovery) |
| F2 | Recovery process started |
| F3 | Recovery firmware image is found |
| F4 | Recovery firmware image is loaded |
| F5-F7 | Reserved for future AML progress codes |
| F8 | Recovery PPI is not available |
| F9 | Recovery capsule is not found |
| FA | Invalid recovery capsule |
| FB–FF | Reserved for future AML error codes |
| 60 | DXE Core is started |
| 61 | NVRAM initialization |
| 62 | Installation of the South Bridge Runtime Services |
| 63-67 | CPU DXE initialization is started |
| 68 | PCI host bridge initialization |
| 69 | North Bridge DXE initialization is started |
| 6A | North Bridge DXE SMM initialization is started |
| 6B-6F | North Bridge DXE initialization (North Bridge module specific) |
| 70 | South Bridge DXE initialization is started |
| 71 | South Bridge DXE SMM initialization is started |
| 72 | South Bridge devices initialization |
| 73-77 | South Bridge DXE Initialization (South Bridge module specific) |
| 78 | ACPI module initialization |

| | |
|-------|---|
| 79 | CSM initialization |
| 7A–7F | Reserved for future AMI DXE codes |
| 80–8F | OEM DXE initialization codes |
| 90 | Boot Device Selection (BDS) phase is started |
| 91 | Driver connecting is started |
| 92 | PCI Bus initialization is started |
| 93 | PCI Bus Hot Plug Controller Initialization |
| 94 | PCI Bus Enumeration |
| 95 | PCI Bus Request Resources |
| 96 | PCI Bus Assign Resources |
| 97 | Console Output devices connect |
| 98 | Console input devices connect |
| 99 | Super IO Initialization |
| 9A | USB initialization is started |
| 9B | USB Reset |
| 9C | USB Detect |
| 9D | USB Enable |
| 9E–9F | Reserved for future AMI codes |
| A0 | IDE initialization is started |
| A1 | IDE Reset |
| A2 | IDE Detect |
| A3 | IDE Enable |
| A4 | SCSI initialization is started |
| A5 | SCSI Reset |
| A6 | SCSI Detect |
| A7 | SCSI Enable |
| A8 | Setup Verifying Password |
| A9 | Start of Setup |
| AA | Reserved for ASL (see ASL Status Codes section below) |
| AB | Setup Input Wait |
| AC | Reserved for ASL (see ASL Status Codes section below) |
| AD | Ready To Boot event |

| | |
|-------|---|
| AE | Legacy Boot event |
| AF | Exit Boot Services event |
| B0 | CPU Memory controller configuration |
| B1 | Runtime Set Virtual Address MAP End |
| B2 | iMC init |
| B3 | Memory training |
| B4 | Memory training |
| B5 | Memory training / timing training |
| B6 | Memory training |
| B7 | Memory training |
| B8-BF | Memory training / DRAM final configuration |
| C0-CF | OEM BDS initialization codes |
| D0 | CPU initialization error |
| D1 | North Bridge initialization error |
| D2 | South Bridge initialization error |
| D3 | Some of the Architectural Protocols are not available |
| D4 | PCI resource allocation error. Out of Resources |
| D5 | No Space for Legacy Option ROM |
| D6 | No Console Output Devices are found |
| D7 | No Console Input Devices are found |
| D8 | Invalid password |
| D9 | Error loading Boot Option (Load Image returned error) |
| DA | Boot Option is failed (Start Image returned error) |

EVGA Glossary of Terms

AC – Alternating Current

ACPI - Advanced Configuration and Power Interface

AHCI – Advanced Host Controller Interface

APIC - Advanced Programmable Interrupt Controller

BCLK – Base Clock (or operating frequency of base system bus)

BIOS - Basic Input Output System

CMOS - Complementary Metal-Oxide Semiconductor

CPU – Central Processing Unit

DC – Direct Current

DDR - Double Data Rate

DIMM - Dual In-line Memory Module

DMI – Direct Memory Interface

DP – Display Port

DRAM - Dynamic random access memory

DVI – Digital Video Interface

ELEET X1 – EVGA motherboard monitoring and tuning software

FIVR – Fully Integrated Voltage Regulator

GHz – Gigahertz

GPU – Graphics Processing Unit

GUI – Graphical User Interface

HDD - Hard Disk Drive

HDMI - High-Definition Multimedia Interface

HDR – High Dynamic Range (Lighting)

HPET - High Precision Event Timer

HT – Hyper-Threading

HSF - Heat Sink Fan

I/O - Input/Output

IEEE - Institute of Electrical and Electronics Engineers

IGP - Integrated Graphics Processors

IMC – Integrated memory controller

IOH – Input/Output Hub

IRQ - Interrupt Request

JBOD - Just a Bunch of Disks

JEDEC - Joint Electron Device Engineering Council

LAN - Local Area Network

LCD - Liquid Crystal Display

LED – Light-Emitting Diode

LGA – Land Grid Array

LN2 – Liquid Nitrogen Cooling

MAC - Media Access Control

M.2 – A card bus based standard commonly used for VERY fast SSD's, and WiFi.

MCP - Media and Communications Processor

Intel® ME – Intel® Management Engine

MHz – Megahertz

MMIO – Memory Mapped I/O

NB - Northbridge

NCQ - Native Command Queuing

NIC - Network Interface Card

NTFS - New Technology File System

NVMe – Non-Volatile Memory Express

OEM - Original Equipment Manufacturer

PATA - Parallel Advanced Technology Attachment

PCB - Printed Circuit Board

PCH – Platform Controller Hub

PCI - Peripheral Component Interconnect

PCIe - Peripheral Component Interconnect Express

PLL – Phase Locked Loop
POST – Power on Self-Test
PWM – Pulse Width Modulation
QDR - Quad Data Rate
QOS – Quality of Service
QPI – Quick Path Interconnect
RAID - Redundant Array of Inexpensive Disks
RAM – Random Access Memory
ROM – Read Only Memory
RGB - Red Green Blue
SATA - Serial Advanced Technology Attachment
SAS – Serial Attached SCSI
SB - Southbridge
SCSI - Small Computer System Interface
SFR – Split Frame Rendering
SLI - Scalable Link Interface
SPD - Serial Presence Detect
S/PDIF - Sony/Philips Digital Interconnect Format
SPP - System Platform Processors
SSD – Solid State Drive
TCP/IP - Transmission Control Protocol/Internet Protocol
UDP – User Datagram Protocol
UEFI – Unified Extensible Firmware Interface
USB - Universal Serial Bus
VDroop - Voltage Droop
VGA - Video Graphics Array
VREG – Voltage Regulator

Compliance Information

FCC Compliance Information

This device complies with FCC Rules Part 15. Operation is subject to the following two conditions: (1) This device may not cause harmful interference, and (2) this device must accept any interference received, including interference that may cause undesired operation. This equipment has been tested and found to comply with the limits for a Class B digital device, pursuant to Part 15 of the FCC Rules. These limits are designed to provide reasonable protection against harmful interference in a residential installation. This equipment generates, uses and can radiate radio frequency energy and, if not installed and used in accordance with the manufacturer's instructions, may cause harmful interference to radio communications. However, there is no guarantee that interference will not occur in a particular installation. If this equipment does cause harmful interference to radio or television reception, which can be determined by turning the equipment off and on, the user is encouraged to try to correct the interference by one or more of the following measures: (1) Increase the separation between the equipment and signal source, or (2) connect the equipment to an outlet on a circuit different from that to which the signal source is connected. Consult the dealer or an experienced computer technician for help. The use of shielded cables for connection of peripheral devices to the PC systems is required to ensure compliance with FCC regulations. Changes or modifications to this unit not expressly approved by the party responsible for compliance could void the user's authority to operate the equipment.

CE Compliance Information

Generic Radiation Interference Standard for Information Technology Equipment. (EN 55022: 2006, Class B), (EN 61000-3-2: 2006), (EN 61000-3-3: 1995 + A1: 2001 + A2: 2005). Warning: This is a Class B product. In a domestic environment this product may cause radio interference in which case the user may be required to take adequate measure. Generic Immunity Standard for Information Technology Equipment. (EN 55024: 1998 + A1: 2001 + A2: 2003).

Trademark & Copyright Information

2001-2020 EVGA Corp. EVGA, the EVGA logo and combinations thereof are trademarks of EVGA Corp. All brand names, company names, service marks, logos, and trademarks of the company, or its affiliates or licensors are trademarks or registered trademarks of the company or its subsidiaries, affiliates or licensors in the US and other countries. Other company, products and service names may be trademarks or service marks of others. EVGA reserves the right to terminate this license if there is a violation of its terms or default by the Original Purchaser. Upon termination, for any reason, all copies of Software and materials must be immediately returned to EVGA and the Original Purchaser shall be liable to EVGA.com CORP for any and all damages suffered as a result of the violation or default.

Legal Information

All material including but not limited to, text, data, design specifications, diagnostics, graphics, logos, reference boards, files, images, drawings, and software including this document and the software itself (together and separately) is owned, controlled by, licensed to, or used with permission by EVGA Corporation and is protected by copyright, trademark, and other Intellectual property rights. All is being provided "as is", EVGA Corporation makes no warranties, whether express or implied, statutory or otherwise with respect to the materials and expressly disclaims all implied warranties of non-infringement, merchantability, and fitness for a particular purpose. In no event shall the liability of EVGA Corporation for claims arising from the use of the materials by anyone exceed the original purchase price of the materials (or replacement of the materials at EVGA Corporation's option). All information furnished is believed to be accurate and reliable. However, EVGA Corporation assumes no responsibility for the consequences of use of such information or for any infringement of patents or other rights of third parties that may result from its use, or use of the Software. No license is granted by implication or otherwise under any patent or patent rights of EVGA Corporation except as expressly provided herein. All specifications mentioned in this publication are subject to change without notice.