

User Guide

EVGA nForce 680i LT SLI
Motherboard
With Intel Processor
Installation and Configuration

Table of Contents

Before You Begin...	vii
Parts NOT in the Kit.....	vii
Intentions of the Kit.....	viii
Introduction to the EVGA nForce 680i LT SLI Motherboard	1
Features	1
Ultimate Overclocking	1
High-speed Memory	1
Comprehensive Overclocking Tools.....	1
NVIDIA nTune Utility	2
NV BIOS.....	2
Designed for NVIDIA SLI Technology	2
True 2 x16 PCI Express SLI Support	2
NVIDIA SLI-Ready Memory.....	2
NVIDIA SLI Certified Components	2
DualDDR2 Memory Architecture	3
NVIDIA MediaShield™ Storage.....	3
Multiple Disk Setup	3
DiskAlert System.....	3
RAID Morphing	3
Bootable Multidisk Array	3
Networking with NVIDIA nForce.....	4
NVIDIA Native Gigabit Ethernet.....	4
NVIDIA FirstPacket™ Technology	4
TCP/IP Acceleration	4
High Definition Audio (HDA)	4
USB 2.0	4
Motherboard Specifications	
Unpacking and Parts Descriptions	7
Unpacking	7

Equipment	7
EVGA nForce 680i LT SLI Motherboard	8
Hardware Installation	11
Safety Instructions	11
Preparing the Motherboard.....	12
Installing the CPU	12
Installing the CPU Fan.....	13
Installing Memory DIMMs	13
Installing the Motherboard	14
Installing the I/O Shield	14
Securing the Motherboard into the Chassis.....	14
Connecting Cables and Setting Switches.....	15
Power Connections	16
24-pin ATX Power (PWR1)	16
8-pin ATX 12V Power (PWR2).....	17
Auxiliary Power for Graphics (PWR3).....	17
Connecting IDE Hard Disk Drives	18
Connecting Serial ATA Cables	18
Connecting Internal Headers.....	19
Front Panel Header	19
IEEE 1394a.....	20
USB Headers	21
Audio.....	22
Fan Connections	23
COM1	24
FDD Connector	24
Expansion Slots	24
PCI Slots	25

PCI Express x1 Slot	25
PCI Express x16 Slots	25
Jumper Settings	26
Clear CMOS Jumper: CLR_CMOS	26
Configuring the BIOS	27
Enter BIOS Setup	28
Main Menu.....	28
Standard CMOS Features Menu	31
Date and Time.....	32
IDE Channel and SATA Channel	32
Drive A	34
Halt On.....	34
Memory	35
Advanced BIOS Features.....	36
Removable Device Priority	37
Hard Disk Boot Priority	37
Network Boot Priority	37
CPU Internal Cache.....	37
Quick Power On Self Test	38
First/Second/Third Boot Device	38
Boot Other Device.....	38
Boot Up NumLock Status.....	38
Security Option.....	39
APIC Mode	39
MPS Version Control For OS.....	39
Full Screen LOGO Show.....	39
Advanced Chipset Features	40
System Clocks	41
Frequency Settings.....	42
HT Multiplier	43

Spread Spectrum	43
FSB & Memory Config	44
CPU Configuration.....	48
System Voltages	49
NVMEM Memory Test	51
PCI Clocks.....	
Load Timing/Voltage Set	51
Save Timing/Voltage Set	52
System BIOS Cacheable	52
HPET Function.....	52
NVIDIA GPU Ex	52
Integrated Peripherals Menu	53
IDE Function Setup.....	54
RAID Config	55
USB Config.....	55
MAC Config	56
IEEE1394 controller	56
HD Audio	56
IDE HDD Block Mode	56
Onboard FDC Controller	56
Onboard Serial Port 1.....	56
Power Management Setup Menu.....	57
ACPI Function.....	57
ACPI Suspend Type	57
Soft-Off by PBNT	58
WOL(PME#) From Soft-Off	58
Power On by Alarm.....	58
POWER ON Function	58

PnP/PCI Configuration Menu.....	59
Init Display First	60
Reset Configuration Data.....	60
Resources Controlled By.....	60
IRQ Resources.....	61
PCI/VGA Palette Snoop.....	61
Maximum Payload Size.....	61
System Monitor Menu	62
Dynamic Fan Control.....	63
Installing Graphics Cards in an SLI Configuration.....	65
Building an SLI System	65
Determine Component and Operating System Needs	65
Install Your NVIDIA SLI-Ready Parts.....	68
Install NVIDIA SLI Software.....	69
Enable NVIDIA SLI.....	70

Before You Begin...

Parts NOT in the Kit

This kit contains all the hardware necessary to install and connect your new EVGA nForce® 680i LT SLI motherboard. However, it does not contain the following items that must be purchased separately to make the motherboard functional.

- ❑ Intel microprocessor:
Intel Core 2 Extreme, Intel Core 2 Duo Pentium EE, Pentium
- ❑ Cooling fan for the microprocessor
- ❑ System memory support:
Supports dual channel DDR2 533/667/800, and up to 800 MHz SLI-Ready Memory. Supports up to 8 GBs DDR2 memory.
- ❑ Graphics Card
This motherboard is capable of using the NVIDIA SLI technology. To utilize this technology requires an SLI Kit from NVIDIA and two SLI-capable graphics cards. When ordering a graphics card, be sure it is a PCI Express card. The kit does contain the SLI connector used to connect the two graphics cards. See *Installing Graphics Cards in an SLI Configuration* on page 65.
- ❑ Power Supply
The power supply requirement is dependent upon the power and the number of the GPUs you install. If you are going to SLI two graphics cards, you are going to require more power. As a rule, for one GPU you need a minimum of a 350 W power supply. If you have two GPUs in an SLI configuration, you will need a minimum of a 500 W power supply. To calculate the power you are going to require for your specific configuration, go to www.slizone.com.

These instructions tell you how to install each of the parts listed so you can have a functioning motherboard. As you go through the installation instructions, we are assuming you have purchased the necessary parts.

Intentions of the Kit

This kit provides you with the motherboard and all connecting cables necessary to install the motherboard into a PC cabinet. If you are *building* a PC, you will use most of the cables provided in the kit. If however, you are *replacing* a motherboard, you will not need many of the cables.

When *replacing* a motherboard in a PC cabinet, you will need to reinstall an operating system even though the current drives have an operating system.

Introduction to the EVGA nForce 680i LT SLI Motherboard

Thank you for buying the EVGA NFORCE 680i LT SLI Motherboard. This motherboard offers the tools and performance PC users' demand. When combined with two SLI-Ready NVIDIA GeForce graphics cards, you get innovative NVIDIA SLI Technology for enhanced system performance.

Features

Ultimate Overclocking

Unleash the underlying hardware. With comprehensive overclocking tools to push the limits on front side bus (FSB) speed and support for higher memory speeds, the EVGA NVIDIA nForce 680i LT SLI MCPs were designed for overclocking.

High-speed Memory

This board supports high-speed SLI-Ready memory up to DDR2-800 to keep pace with overclocked system components.

Comprehensive Overclocking Tools

Award-winning NVIDIA overclocking tools provide a complete kit of tools giving everyone from the most veteran enthusiast to the novice overclocker the ability to unleash the hardware in their PC.

NVIDIA nTune Utility

NVIDIA nTune™ is a Windows-based utility that has added access to more settings. Adjust CPU and memory speeds without rebooting. You can also access most BIOS settings from inside Windows without having to go into the BIOS. Save and automatically load profiles for each application you run.

NV BIOS

NV BIOS delivers easy-to-use tuning to let you have full control over your hardware including processor voltage tables and memory drive strengths.

Designed for NVIDIA SLI Technology

NVIDIA SLI technology is a revolutionary platform innovation that allows users to intelligently scale graphics performance by combining multiple NVIDIA graphics solutions in a single system with an NVIDIA nForce 680i LT SLI MCP.

True 2 x16 PCI Express SLI Support

Two full-bandwidth, 16-lane PCI Express links ensure maximum graphics performance for next-generation GPUs and games. True 2 x16 PCI Express SLI Support offers twice the PCI Express bandwidth of x8 SLI solutions.

NVIDIA SLI-Ready Memory

NVIDIA nForce 680i LT SLI MCP automatically increases bandwidth when select SLI Certified memory modules are detected.

NVIDIA SLI Certified Components

Look for other components including NVIDIA® GeForce® GPUs and system memory that have been certified by NVIDIA to deliver unmatched performance with the EVGA nForce 680i LT SLI motherboard. For more information on SLI Certified components, visit www.SLIZone.com/nForce.

Dual DDR2 Memory Architecture

A state-of-the-art Dual DDR2 memory controller allows high bandwidth and low latency data access to the CPU and GPU. Ensures data and information are relayed through the system as quickly as possible for incredible performance.

NVIDIA MediaShield™ Storage

NVIDIA MediaShield is a suite of features that safeguards your most important digital media assets; always reliable, scalable, and accessible. MediaShield includes RAID and SATA drive support.

Multiple Disk Setup

Through a simple wizard-based interface, you can effortlessly set up your drives for better data protection, faster disk access or maximum storage capacity. MediaShield automatically selects RAID 0, 1, 0+1 or 5 configurations according to your needs. Advanced users can access RAID options directly.

DiskAlert System

The event of a disk failure, MediaShield users see an image that highlights which disk has failed to make it easier to identify, replace, and recover.

RAID Morphing

MediaShield allows users to change their current RAID set-up to another configuration in a one-step process called morphing. This eliminates the need to back up data and follow multiple steps in the process.

Bootable Multidisk Array

MediaShield storage fully supports the use of multi-disk array for loading the operating system at power-up.

Networking with NVIDIA nForce

NVIDIA networking delivers the highest network throughput at the lowest CPU utilization. The manageable and stable NVIDIA networking solution results in better networking management and a lower total cost of ownership. Only NVIDIA integrates this level of networking features to allow you to take your online experience to the next level.

NVIDIA Native Gigabit Ethernet

The industry's fastest Gigabit Ethernet performance eliminates network bottlenecks and improves overall system efficiency and performance.

NVIDIA FirstPacket™ Technology

Be the 'King of Ping' with NVIDIA FirstPacket technology. Get the crystal-clear phone conversations and online gaming performance you expect. NVIDIA FirstPacket technology assures your game data, VoIP conversations, and large file transfers are delivered according to preferences set by you in an intuitive wizard.

TCP/IP Acceleration

TCP/IP Acceleration delivers the highest system performance by offloading CPU-intensive packet filtering tasks in hardware, providing users with a PC networking environment that is faster.

High Definition Audio (HDA)

High definition audio brings consumer electronics quality sound to the PC delivering high quality sound from multiple channels. Using HDA, systems can deliver 192 kHz/32-bit quality for eight channels, supporting new audio formats.

USB 2.0

USB 2.0 is standard plug-and-play interface that provides easy-to-use connectivity for USB devices.

Motherboard Specifications

- ❑ Size
 - ATX form factor of 12 inch x 9.6 inch
- ❑ Microprocessor support
 - Intel Core 2 Extreme, Intel Core 2 Quad, Intel Core 2 Duo, Pentium EE, Pentium
- ❑ Operating systems:
 - Supports Windows XP 32bit/64bit and Windows Vista 32bit/64bit
- ❑ Contains NVIDIA nForce 680i LT SLI MCP and SPP
- ❑ System Memory support
 - Supports dual channel JEDEC DDR2-800 and SLI-Ready memory up to 800 MHz. Supports up to 8 GBs DDR2 memories.
- ❑ USB 2.0 Ports
 - Supports hot plug
 - Eight USB 2.0 ports (four rear panel ports, four onboard USB headers)
 - Supports wake-up from S1 and S3 mode
 - Supports USB 2.0 protocol up to 480 Mbps transmission rate
- ❑ Onboard Serial ATA II
 - 300MBps data transfer rate
 - Six Serial ATA II connectors
 - NVIDIA MediaShield RAID with support for RAID 0, RAID 1, RAID 0+1, RAID 5, and JBOD
 - Supports hot plug and NCQ (Native Command Queuing)
- ❑ Onboard LAN
 - Single LAN interface built-in onboard
 - Supports 10/100/1000 Mbit/sec Ethernet

- ❑ Onboard 1394
 - Support hot plug
 - Two 1394a ports (one rear panel port, one onboard header) with rate of transmission at 400 Mbps
- ❑ Onboard Audio
 - Azalia High-Definition audio
 - Supports 8-channel audio
 - Supports S/PDIF output
 - Supports Jack-Sensing function
- ❑ Dual PCI Express x16 Support
 - Supports 4 GB/sec (8 GB/sec concurrent) bandwidth
 - Low power consumption and power management features
- ❑ Green Function
 - Supports ACPI (Advanced Configuration and Power Interface)
 - Supports S0 (normal), S1 (power on suspend), S3 (suspend to RAM), S4 (Suspend to disk - depends on OS), and S5 (soft - off)
- ❑ Expansion Slots
 - Two PCI slots
 - Two PCI Express x1 slot
 - Two PCI Express x16 Graphics slots

Unpacking and Parts Descriptions

Unpacking

The EVGA nForce 680i LT SLI motherboard comes with all the necessary cables for adding a motherboard to a new chassis. If you are replacing a motherboard, you may not need many of these cables.

Be sure to inspect each piece of equipment shipped in the packing box. If anything is missing or damaged, contact your reseller.

All parts shipped in this kit are RoHS-compliant (lead-free) parts.

Equipment

The following equipment is included in the EVGA nForce 680i LT SLI motherboard box.

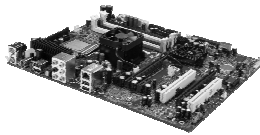

EVGA nForce 680i LT SLI Motherboard

This PCI Express motherboard contains the NVIDIA nForce 680i LT SLI SPP and MCP and is SLI-ready.



I/O Shield

Installs in the chassis to block radio frequency transmissions, protect internet components from dust and foreign objects and aids in proper airflow within the chassis.









Floppy Cable

Used to attach a floppy drive to the motherboard.



2-Port SATA Power Cable (Qty Three)

	<p>1394 Cable Provides two additional 1394 ports to either the front or back panels of the chassis.</p>
	<p>USB 2.0 4-Port Cable Provides four additional USB ports to either the front or back panels of the chassis.</p>
	<p>SATA Signal Cable (Qty Six) Used to support the Serial ATA protocol and each one connects a single drive to the motherboard</p>
	<p>Comm2 Bracket Cable</p>
	<p>IDE-ATA 133 HDD Cable</p>
	<p>SLI Connector Used to connect two graphic cards installed in the x16 PCI Express slots in an SLI configuration.</p>

EVGA nForce 680i LT SLI Motherboard

The EVGA nForce 680i LT SLI motherboard with the NVIDIA nForce 680i LT SLI SPP and MCP processors is a PCI Express, SLI-ready motherboard. Figure 1 shows the motherboard and Figures 2 shows the back panel connectors.

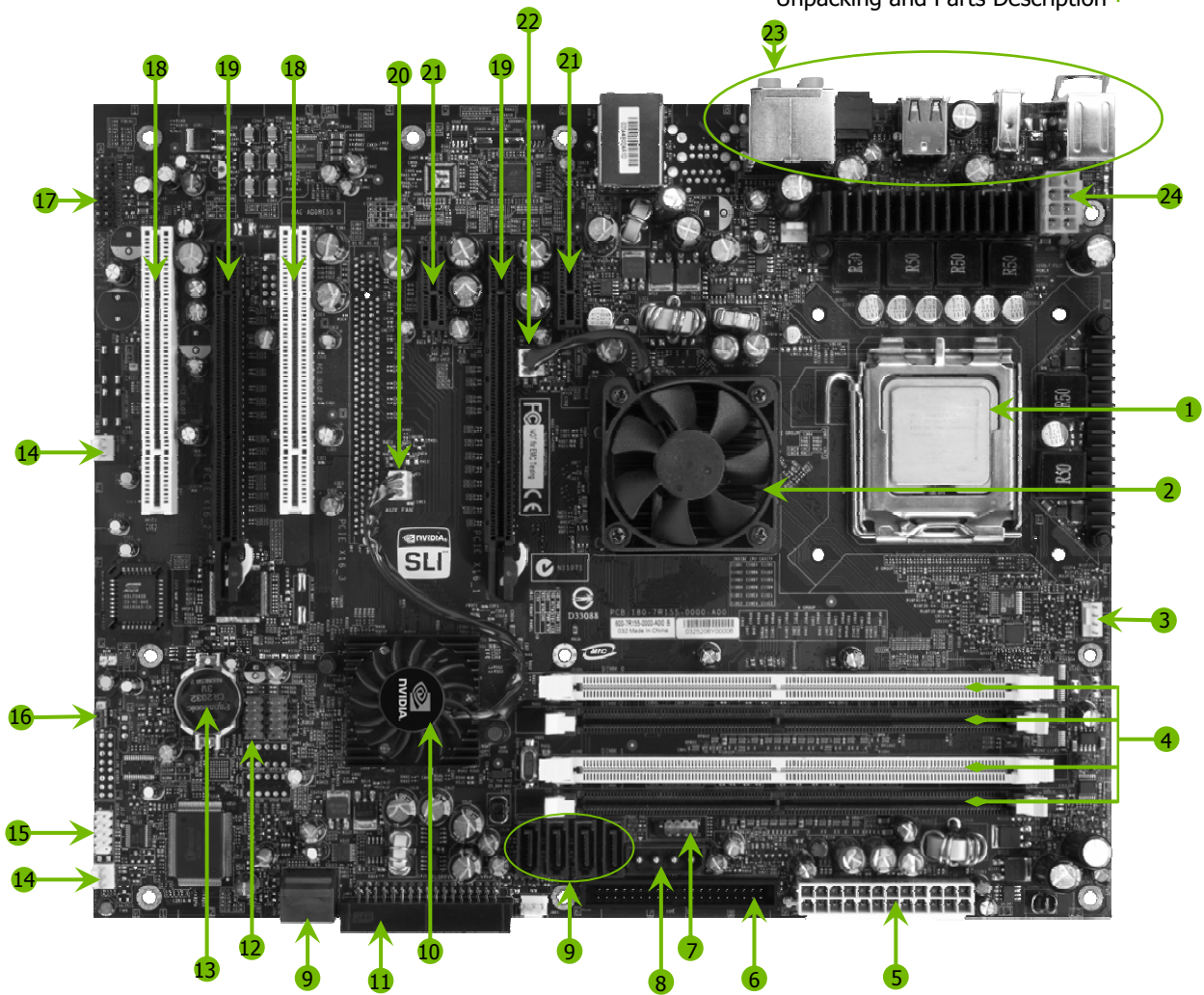

- | | | |
|-------------------------------|----------------------------|-------------------------------------|
| 1. CPU Socket | 9. Serial-ATA connectors | 17. Front Audio connector |
| 2. NVIDIA SPP with Active fan | 10. NVIDIA MCP | 18. PCI slots |
| 3. CPU fan connector | 11. Floppy drive connector | 19. PCI Express x16 slots (SLI) |
| 4. DDR DIMM Slots 0 - 3 | 12. USB headers | 20. NVIDIA MCP fan connector |
| 5. 24-pin ATX Power Connector | 13. Motherboard battery | 21. PCI Express x1 slot |
| 6. FDD Connector | 14. Fan Headers | 22. NVIDIA SPP fan connector |
| 7. Front panel connector | 15. Serial connector | 23. Backpanel connectors (Figure 2) |
| 8. AUX PEX Power connector | 16. Clear CMOS | 24. 8-pin ATX_12V power connector |

Figure 1. EVGA nForce 680i LT SLI Motherboard Layout

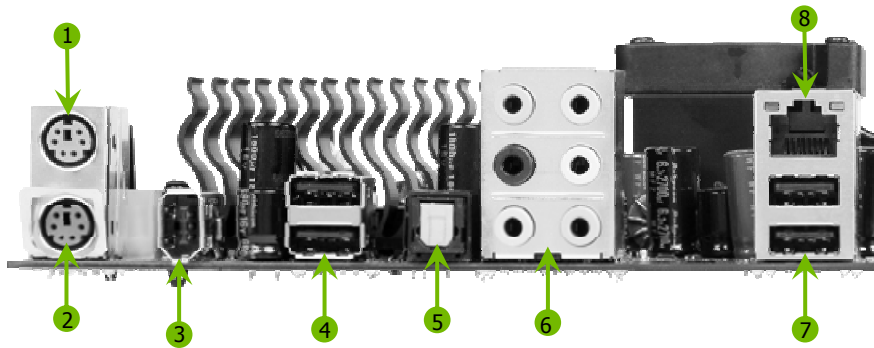

1. PS/2 Mouse Port
2. PS/2 Keyboard Port
3. 1394a (Firewire) Port
4. USB 2.0 ports (two)
5. SPDIF output
6.

Port	2-Channel	4-Channel	6-Channel/8-Channel
Blue	Line-In	Line-In	Line-In
Green	Line-Out	Front Speaker Out	Front Speaker Out
Pink	Mic In	Mic In	Mic In
Orange			Center/Subwoofer
Black		Rear Speaker Out	Rear Speaker Out
Grey			
7. USB 2.0 Ports (two)
8. Lan Port with LEDs to indicate status.
 - Yellow/Light Up/Blink = 10 Mbps/Link/Activity
 - Yellow and Green/Light Up/Blink = 100 Mbps/link/Activity
 - Green/Light Up/Blink = 1000 Mbps/Link/Activity

Figure 2. Chassis Backpanel Connectors

Hardware Installation

This section will guide you through the installation of the motherboard. The topics covered in this section are:

- ❑ Preparing the motherboard
 - Installing the CPU
 - Installing the CPU fan
 - Installing the memory
- ❑ Installing the motherboard
- ❑ Connecting cables and setting switches

Safety Instructions

To reduce the risk of fire, electric shock, and injury, always follow basic safety precautions.

Remember to remove power from your computer by disconnecting the AC main source before removing or installing any equipment from/to the computer chassis.

Preparing the Motherboard

The motherboard shipped in the box does *not* contain a CPU or memory. You need to purchase a CPU, a CPU fan assembly, and memory to complete this installation.

Installing the CPU

Be very careful when handling the CPU. Make sure not to bend or break any pins on the back. Hold the processor only by the edges and do not touch the bottom of the processor.

Use the following procedure to install the CPU onto the motherboard.

1. Unhook the socket lever by pushing *down* and *away* from the socket.
2. Lift the load plate. There is a protective socket cover on the load plate to protect the socket when there is no CPU installed.
3. Remove the protective socket cover from the load plate.
4. Remove the processor from its protective cover, making sure you hold it only by the edges. It is a good idea to save the cover so that whenever you remove the CPU, you have a safe place to store it.
5. Align the notches in the processor with the notches on the socket.
6. Lower the processor straight down into the socket with out tilting or sliding it into the socket

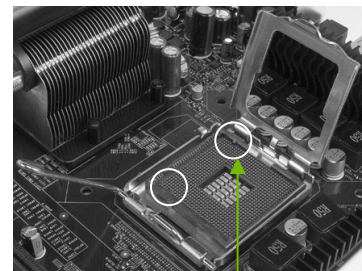
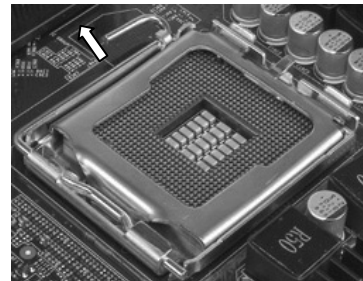

Align notches with notches on the CPU

Note: Make sure the CPU is fully seated and level in the socket.

7. Close the load plate over the CPU and press down while you close and engage the socket lever.



Installing the CPU Fan

There are many different fan types that can be used with this motherboard. Follow the instruction that came with you fan assembly. Be sure that the fan orientation is correct for your chassis type and your fan assembly.

Installing Memory DIMMs

Your new motherboard has four 1.8V 240-pin slots for DDR2 memory. These slots support 256 MB, 512 MB, 1 GB and 2 GB DDR2 technologies for x8 and x16 devices. They also support dual channel DDR2 memory technology up to 10.7GB/s. There must be at least one memory bank populated to ensure normal operation. Use the following the recommendations for installing memory. (See Figure 1 on page 9 for the location of the memory slots on the card)

- ❑ One DIMM: Install into slot 0. You can install the DIMM into any slot, however, slot 0 is preferred.
- ❑ Two DIMMs: Install into either slots 0 and 1 or 2 and 3. The idea is to not have the DIMMs in adjacent slots.
- ❑ Four DIMMS: Install into slots 0, 1, 2, and 3.

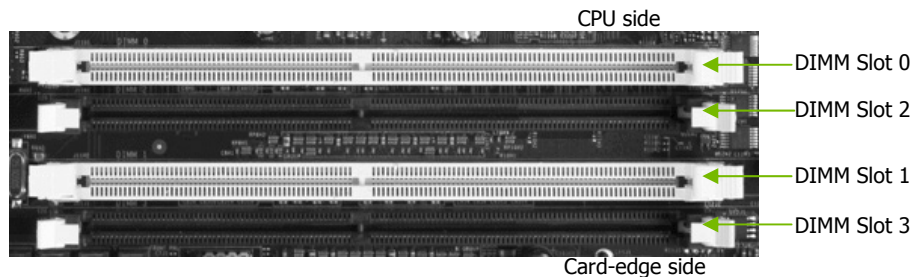

Use the following procedure to install memory DIMMs into the slots on the motherboard. Note that there is only one gap near the center of the DIMM slot. This slot matches the slot on the memory DIMM to ensure the component is installed properly.

1. Unlock a DIMM slot by pressing the module clips outward.
2. Align the memory module to the DIMM slot, and insert the module vertically into the DIMM slot. The plastic clips at both sides of the DIMM slot automatically lock the DIMM into the connector.

Installing the Motherboard

The sequence of installing the motherboard into the chassis depends on the chassis you are using and if you are replacing an existing motherboard or working with an empty chassis. Determine if it would be easier to make all the connections prior to this step or to secure the motherboard and then make all the connections. Use the following procedure to install the I/O shield and secure the motherboard into the chassis.

Note: Be sure that the CPU fan assembly has enough clearance for the chassis covers to lock into place and for the expansion cards. Also make sure the CPU Fan assembly is aligned with the vents on the covers.

Installing the I/O Shield

The motherboard kit comes with an I/O shield that is used to block radio frequency transmissions, protects internal components from dust and foreign objects, and promotes correct airflow within the chassis.

Before installing the motherboard, install the I/O shield from the *inside* of the chassis. Press the I/O shield into place and make sure it fits securely. If the I/O shield does not fit into the chassis, you would need to obtain the proper size from the chassis supplier.

Securing the Motherboard into the Chassis

Most computer chassis have a base with mounting studs or spacers to allow the mother board to be secured to the chassis and help to prevent short circuits. If there are studs that do not align with a mounting hole on the motherboard, it is recommended that you remove that stud to prevent the possibility of a short circuit.

1. Carefully place the motherboard onto the studs/spacers located inside the chassis.
2. Align the mounting holes with the studs/spacers.
3. Align the connectors to the I/O shield.
4. Ensure that the fan assembly is aligned with the chassis vents according to the fan assembly instruction.
5. Secure the motherboard with a minimum of eight-to-ten screws.

Connecting Cables and Setting Switches

This section takes you through all the connections and switch settings necessary on the motherboard. This will include:

- ❑ Power Connections
 - 24-pin ATX power (**PWR1**)
 - 8-pin ATX 12V power (**PWR2**)
 - Auxiliary power for graphics (**PWR3**)
- ❑ Internal Headers
 - Front panel
 - IEEE 1394a
 - USB Headers
 - Audio
 - COM
- ❑ FDD
- ❑ IDE
- ❑ Serial ATA II
- ❑ Chassis Fans
- ❑ Rear panel USB 2.0 Adapter
- ❑ Expansion slots
- ❑ CMOS jumper settings

See Figure 1 on page 9 to locate the connectors and jumpers referenced in the following procedure.

Power Connections

This motherboard requires an ATX power supply. To support a PCI Express motherboard with the addition of dual graphics cards using NVIDIA SLI technology, you are going to need a minimum of a 500W power supply. Make sure you have enough power to cover all the expansion cards you will be installing. To determine what your power requirements are for your specific configuration, refer to www.slizone.com.

24-pin ATX Power (PWR1)

PWR1 is the main power supply connector located along the edge of the board next to the DIMM slots. Make sure that the power supply cable and pins are properly aligned with the connector on the motherboard. Firmly plug the power supply cable into the connector and make sure it is secure.

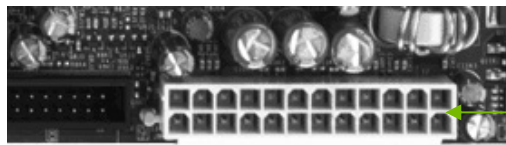

PWR1 connector
Plug power cable from system power supply to PWR1

Figure 3. PWR1 Motherboard Connector

Table 1. PWR1 Pin Assignments

Connector	Pin	Signal	Pin	Signal
	1	+3.3V	13	+3.3V
	2	+3.3V	14	-12V
	3	GND	15	GND
	4	+5V	16	PS_ON
	5	GND	17	GND
	6	+5V	18	GND
	7	GND	19	GND
	8	PWROK	20	RSVD
	9	+5V_AUX	21	+5V
	10	+12V	22	+5V
	11	+12V	23	+5V
	12	+3.3V	24	GND

8-pin ATX 12V Power (PWR2)

PWR2, the 8-pin ATX 12V power connection, is used to provide power to the CPU. Align the pins to the connector and press firmly until seated.

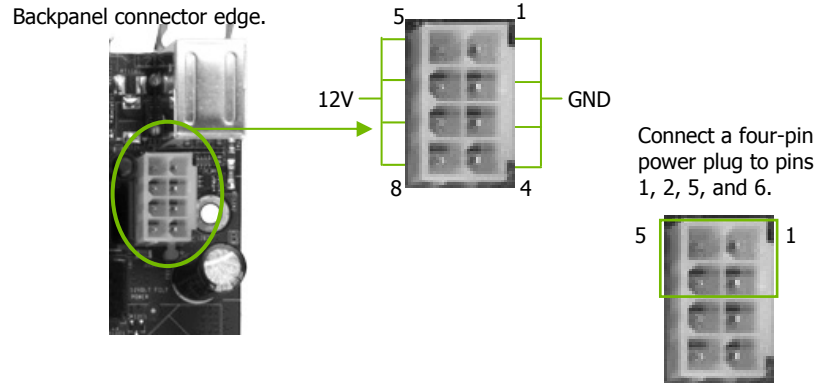

It is *strongly* recommended that you use an 8-pin ATX 12V power supply; however, if you have a four-pin power supply, plug the connector to pins 1, 2, 5, and 6 as shown.

Auxiliary Power for Graphics (PWR3)

The **PWR3** connector is an auxiliary power connection for graphics cards. Exclusive power for the graphics card provides better graphics performance.

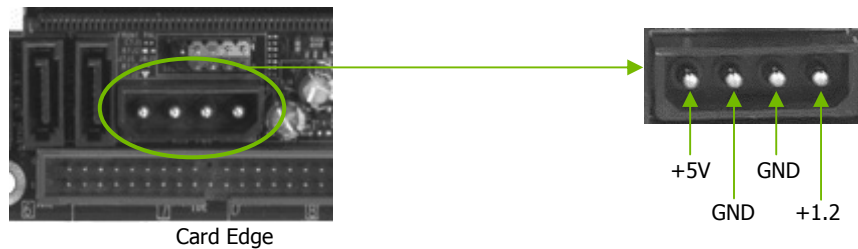

Connecting IDE Hard Disk Drives

The IDE connector supports Ultra ATA 133/100/66 IDE hard disk drives.

1. Connect the blue connector (the cable end with a single connector) to the motherboard.
2. Connect the black connector (the cable with the two closely spaced black and gray connectors) to the Ultra ATA master device.
3. Connect the gray connector to a slave device.

If you install two hard disk drives, you must configure the second drive as a slave device by setting its jumper accordingly. Refer to the hard disk documentation for the jumper settings.

Note: If an ATA-66/100 disk drive and a disk drive using any other IDE transfer protocol are attached to the same cable, the maximum transfer rate between the drives may be reduced to that of the slowest drive.

Connecting Serial ATA Cables

The Serial ATA II connector is used to connect the Serial ATA II device to the motherboard. These connectors support the thin Serial ATA II cables for primary storage devices. The current Serial ATA II interface allows up to 300MB/s data transfer rate.

There are six serial ATA connectors on the motherboard that support RAID 0, RAID 1, RAID 5, RAID 0+1 and JBOD configurations.

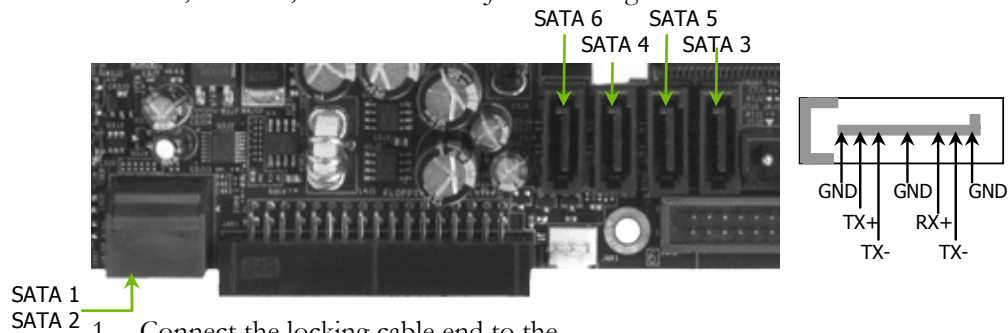

1. Connect the locking cable end to the motherboard connector.
2. Connect the end without the lock to the drive.

Connecting Internal Headers

Front Panel Header

The front panel header on this motherboard is one connector used to connect the following four cables:

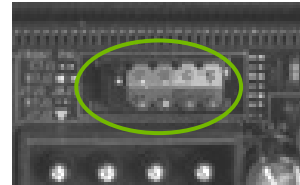

❑ **PWRLED**

Attach the front panel power LED cable to these two pins of the connector.

The Power LED indicates the system's status. When the system is in S0 status, the LED is on. When the system is in S1, S3, S4, S5 status, the LED is off.

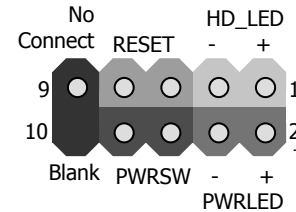

Note: The power LED cable in some chassis is a three pin connector with the pins installed in positions 1 and 3. If your chassis has a three pin connector, you will need to remove pin 3 and put it into position 2 or you can use a pair of scissors to cut out position 2. Most chassis come with a two pin connector.

❑ **PWRSW**

Attach the power button cable from the case to these two pins. Pressing the power button on the front panel turns the system on off rather than using the power supply button.

❑ **HD_LED**

Attach the hard disk drive indicator LED cable to these two pins. The HDD indicator LED indicates the activity status of the hard disks.

❑ **RESET**

Attach the Reset switch cable from the front panel of the case to these two pins. The system restarts when the **RESET** switch is pressed.

Table 2. Front Panel Header Pins

	Pin	Signal	In/Out	Description
HD_LED	1	HD_PWR	Out	Hard disk LED pull-up to +5V
	3	HDA#	Out	Hard disk active LED
PWRLED	2	HDR_BLNK_GRN	Out	Front panel green light
	4	HDR_BLNK_YEL	Out	Front panel yellow light
RESET	5	GND		Ground
	7	FP_RESET#	In	Reset switch
PWRSW	6	SWITCH_ON#	In	Power switch
	8	GND		Ground
No Connect	9	No Connect		
Empty	10	Empty		

IEEE 1394a

The IEEE 1394 expansion cable bracket is provided in the box but if you do not require the additional external connections, you do not need to install it.

1. Secure the bracket to either the front or rear panel of your chassis (not all chassis are equipped with the front panel option).
2. Connect the two ends of the cables to the IEEE 1394 connectors on the motherboard.

Table 3. IEEE 1394a Connector Pins

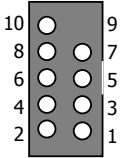
Connector	Pin	Signal
IEEE 1394a Connector 	1	TPA+
	2	TPA-
	3	GND
	4	GND
	5	TPB+
	6	TPB-
	7	+12V
	8	+12V
	9	Empty
	10	GND

USB Headers

This motherboard contains four (4) USB 2.0 ports that are exposed on the rear panel of the chassis. The motherboard also contains two 10-pin internal header connectors onboard that can be used to connect an optional external bracket containing four (4) more USB 2.0 ports.



1. Secure the bracket to either the front or rear panel of your chassis (not all chassis are equipped with the front panel option).
2. Connect the two ends of the cables to the USB 2.0 headers on the motherboard.

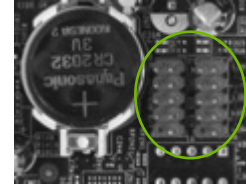
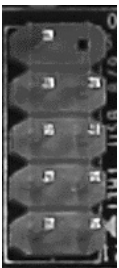

Table 4. USB 2.0 Header Pins

Connector	Pin	Signal	Pin	Signal
USB 2.0 Header Connector 	1	5V_DUAL	2	5V_DUAL
	3	D-	4	D-
	5	D+	6	D+
	7	GND	8	GND
	9	Empty	10	No Connect

Audio

The audio connector supports HD audio standard and provides two kinds of audio output choices: the Front Audio, the Rear Audio. The front Audio supports re-tasking function.

Table 5. Front Audio Connector

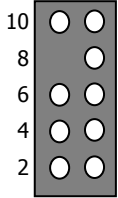
Connector	Pin	Signal
Front Audio Connector 	1	PORT1_L
	2	AUD_GND
	3	PORT1_R
	4	PRECENCE_J
	5	PORT2_R
	6	SENSE1_RETURN
	7	SENSE_SEND
	8	Empty
	9	PORT2_L
	10	SENSE2_RETURN

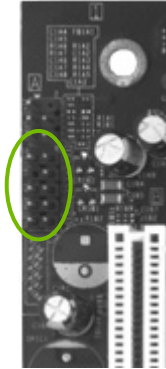

Fan Connections

There are two fan connections, the system fan and the CPU fan. The fan speed can be detected and viewed in the **PC Health Status** section of the CMOS Setup. Both fans are automatically turned off after the system enters S3, S4 and S5 mode.

The nForce 680i LT SLI SPP and MCP have active fans to help to cool the chips. The fans plug into a 3-pin connector.

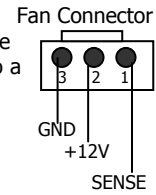

nForce 680i LT SLI MCP fan connector.

nForce 680i LT SLI SPP fan connector.



Note that the CPU fan cable can be either a 3-pin or a 4-pin connector. Connect a 3-pin connector to pins 1, 2, and 3 on the motherboard connector.

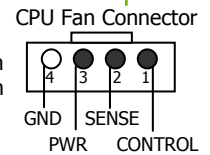

COM1

The motherboard kit provides an additional serial COM header for your machine. Connect one side of a switching cable to the header and then attach the serial COM device to the other side of the cable.

FDD Connector

The motherboard supports a standard 360K, 720K, 1.2M, 1.44m, and a 2.88M floppy disk drive (FDD).

Expansion Slots

The EVGA nForce 680i LT SLI motherboard contains six expansion slots, four PCI Express slots and two PCI slots. For a full list of PCI Express x16 graphics card supported by this motherboard, go to www.nvidia.com/products

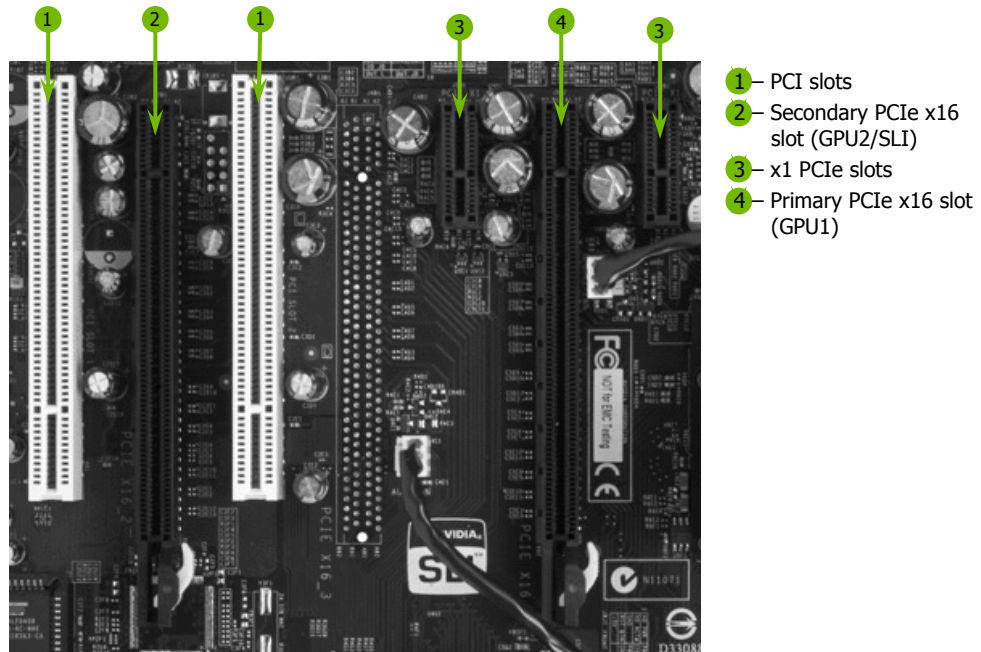

Figure 4. Expansion Slots

PCI Slots

The two PCI slots support many expansion cards such as a LAN card, USB card, SCSI card and other cards that comply with PCI specifications. When installing a card into the PCI slot, be sure that it is fully seated. Secure the card's metal bracket to the chassis back panel with the screw used to hold the blank cover.

PCI Express x1 Slot

There are two PCI Express x1 slots that are designed to accommodate less bandwidth-intensive cards, such as a modem or LAN card. The x1 slot provides 250 MB/sec bandwidth.

PCI Express x16 Slots

These two PCI Express x16 slots are reserved for graphics or video cards. The bandwidth of the x16 slot is up to 4GB/sec (8GB/sec concurrent). The design of this motherboard supports dual PCI-Express graphics cards using NVIDIA's SLI technology with multiple displays.

When installing a PCI Express x16 card, be sure the retention clip snaps and locks the card into place. If the card is not seated properly, it could cause a short across the pins. Secure the card's metal bracket to the chassis back panel with the screw used to hold the blank cover.

To configure for SLI, follow the instructions that come with the SLI kit (the kit is purchased separately from the motherboard).

Jumper Settings

The motherboard contains a 3-pin BIOS configuration jumper that enables all board configurations to be done in the BIOS Setup program.

The silk screen on the motherboard shows a Δ next to pin 1.

Clear CMOS Jumper: CLR_CMOS

The motherboard uses the CMOS RAM to store all the set parameters. The CMOS can be cleared by removing the CMOS jumper.

Use the following procedure to clear CMOS:

1. Turn off the AC power supply and connect pins 1 and 2 together using the jumper cap.
2. Return the jumper setting to normal (pins 2 and
3. Together with the jumper cap).
4. Turn the AC power supply back on.

Configuring the BIOS

This section discusses how to change the system settings through the BIOS Setup menus. Detailed descriptions of the BIOS parameters are also provided.

This section includes the following information:

- Enter BIOS Setup
- Main Menu
- Standard CMOS Features
- Advanced BIOS Features
- Advanced Chipset Features
- Integrated Peripherals
- Power Management Setup
- PnP/PCI Configurations
- System Monitor

Enter BIOS Setup

The BIOS is the communication bridge between hardware and software. Correctly setting the BIOS parameters is critical to maintain optimal system performance.

Use the following procedure to verify/change BIOS settings.

1. Power on the computer,
2. Press the **Del** key when the following message briefly displays at the bottom of the screen during the Power On Self Test (POST).

Press F1 to continue, DEL to enter Setup.

Pressing **Del** takes you to the Phoenix-Award BIOS CMOS Setup Utility.

Note: It is *strongly* recommended that you do not change the default BIOS settings. Changing some settings could damage your computer.

Main Menu

The main menu allows you to select from the list of setup functions and two exit choices. Use the **Page Up** and **Page Down** keys to scroll through the options or press **Enter** to display the associated submenu. Use the **↑↓** arrow keys to position the selector in the option you choose. To go back to the previous menu, press **Esc**.

Note: Note that on the BIOS screens all data in **white** is for information only, data in **yellow** is changeable, data in **blue** is non-changeable, and data in a **red box** is highlighted for selection.

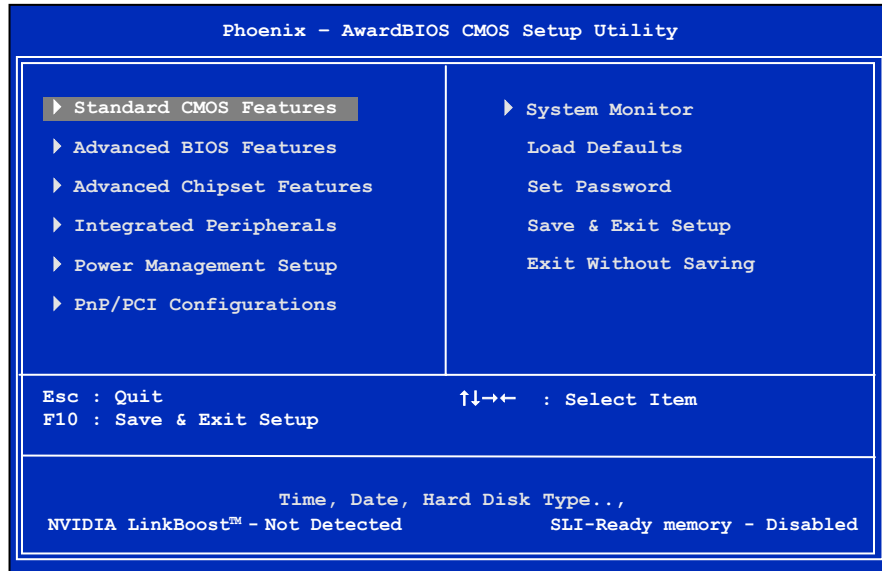

Figure 5. BIOS CMOS Setup Utility Main Menu

- ❑ **Standard CMOS Features**
Use this menu to set up the basic system configuration.
- ❑ **Advanced BIOS Features**
Use this menu to set up the advanced system features and boot sequence.
- ❑ **Advanced Chipset Features**
Use this menu to optimize system performance and configure clocks, voltages, memory timings, and more.
- ❑ **Integrated Peripherals**
Use this menu to set up onboard peripherals such as IDE, RAID, USB, LAN, and MAC control.
- ❑ **Power Management Setup**
Use this menu to configure power management, power on, and sleep features.
- ❑ **PnP/PCI Configurations**
Use this menu to modify the system's Plug-and-Play and PCI configurations.
- ❑ **System Monitor**
Use this menu to monitor the real-time system status of your PC, including temperature, voltages, and fan speed.

The following items on the CMOS Setup Utility main menu are commands rather than submenus:

- ❑ **Load Defaults**
Load default system settings.
- ❑ **Set Password**
Use this command to set, change, and disable the password used to access the BIOS menu.
- ❑ **Save & Exit Setup**
Use this command to save settings to CMOS and exit setup.
- ❑ **Exit Without Saving**
Use this command to abandon all setting changes and exit setup.

The following two items on the CMOS Setup Utility main menu are status indicators:

- ❑ **NVIDIA LinkBoost (Status indication at bottom of screen)**
This status indicator is displayed at the bottom of the BIOS screen and consists of the following remarks:
 - **Detected:** System detects LinkBoost-capable components.
 - **Not Detected:** The LinkBoost components are not detected.
- ❑ **SLI-Ready Memory (Status indication at bottom of screen)**
This status indicator is displayed at the bottom of the BIOS screen and consists of the following remarks:
 - **Enabled:** SLI-Ready memory is detected and enabled.
 - **Disabled:** SLI-Ready memory is detected but disabled.
 - **Not Detected:** SLI-Ready memory is not detected.

Standard CMOS Features Menu

The Standard CMOS Features menu is used to configure the standard CMOS information, such as the date, time, HDD model, and so on. Use the **Page Up** and **Page Down** keys to scroll through the options or press **Enter** to display the sub-menu. Use the **↑↓** arrow keys to position the selector in the option you choose. To go back to the previous menu, press **Esc**.

The information shown in **Item Help** corresponds to the option highlighted.

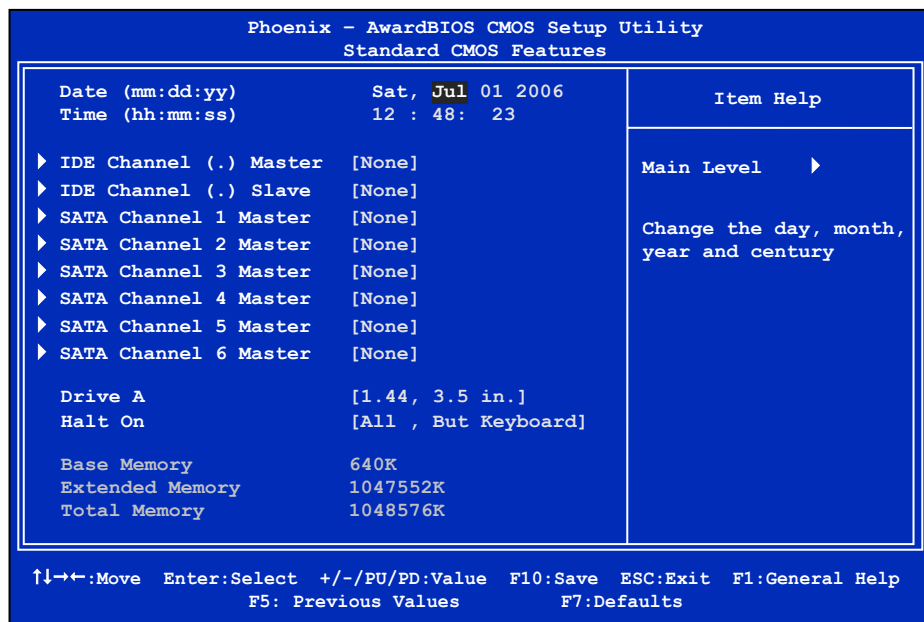

Figure 6. Standard CMOS Features Menu

Note: Note that all data in **white** is for information only, data in **yellow** is changeable, data in **blue** is non-changeable, and data in a **red box** is highlighted for selection.

Date and Time

Using the arrow keys, position the cursor over the month, day, and year. Use the **Page Up** and **Page Down** keys to scroll through dates and times. Note that the weekday (Sun through Sat) cannot be changed. This field changes to correspond to the date you enter. Note that the hour value is shown in a 24-hour clock format. Time is represented as **hour : minute : second**

```
Date (mm:dd:yy)      Sat, Jul 01 2006
Time (hh:mm:ss)     14 : 48: 43
```

IDE Channel and SATA Channel

Use these functions to detect and configure the individual IDE and SATA channels. Select a channel and press **Enter** to display the IDE/SATA sub-menu.

The diagram illustrates the navigation process through the BIOS menu. It starts with a main menu listing IDE and SATA channels. A green arrow points from the 'IDE Channel (.) Slave' option to a sub-menu titled 'IDE HDD Auto-Detect'. From there, another green arrow points to a sub-menu titled 'IDE Auto-Detect'. Text annotations indicate that pressing 'ENTER' leads to these sub-menus.

```
▶ IDE Channel (.) Master [None]
▶ IDE Channel (.) Slave [None]
▶ SATA Channel 1 Master [None]
▶ SATA Channel 2 Master [None]
▶ SATA Channel 3 Master [None]
▶ SATA Channel 4 Master [None]
▶ SATA Channel 5 Master [None]
▶ SATA Channel 6 Master [None]
```

Press ENTER to display IDE Channel sub-menu

```
IDE HDD Auto-Detect [Press Enter]

IDE Channel 0 Slave [Manual}
Access Mode [CHS]

Capacity 0 MB

Cylinder [ 0]
Head [ 0]
Precomp [ 0]
Landing Zone [ 0]
Sector [ 0]
```

Press ENTER to display SATA Channel sub-menu

```
IDE Auto-Detect [Press Enter]

Extended IDE Drive [None}
Access Mode Auto

Capacity 0 MB

Cylinder 0
Head 0
Precomp 0
Landing Zone 0
Sector 0
```

Press **Enter** to auto-detect IDE and SATA channels in the system. Once the channel is detected, the values for Capacity, Cylinder, Heads, Precomp, Landing Zone, and Sector are automatically filled in.

❑ **None**

There is no HDD installed or set.

❑ **Auto**

The system can auto-detect the hard disk when booting up.

❑ **Manual**

When you set the channel to **[Manual]** and change **Access Mode** to **[CHS]**, you can then enter the number of cylinders, heads, Precomp, landing zone, and sector. You can manually enter the values or you can press **Enter** to display a window that tells you the min and max values.

The image shows two screenshots from a BIOS configuration utility. The left screenshot displays the 'IDE HDD Auto-Detect' screen with the following settings: IDE Channel 0 Slave (Manual), Access Mode (CHS), Capacity (0 MB), Cylinder (0), Head ([0]), Precomp ([0]), Landing Zone ([0]), and Sector ([0]). A green arrow points from the 'Cylinder' field to a sub-menu window on the right. The sub-menu window is titled 'Cylinder' and shows 'Min= 0' and 'Max=65535'. It prompts the user to 'Key in a DEC number : []' and includes navigation instructions at the bottom: '↑↓:Move ENTER:Accept ESC:Abort'.

The BIOS supports the following HDD Access Modes:

- **CHS**
For HDD less than 528 MB.
- **LBA**
For HDD greater than 528 MB and supporting LBA (Logical Block Addressing).
- **Large**
For HDD greater than 528 MB but not supporting LBA.
- **Auto**
Recommended mode.

Drive A

The **Drive A** option allows you to select the kind of FDD to install. Options are:

```
Drive A      [1.44, 3.5 in.]
Halt On     [All , But Keyboard]
```

Press ENTER to display sub-menu

- None
- 360K, 5.25 in.
- 1.2M, 5.25 in.
- 720K, 3.5 in.
- 1.44M, 3.5 in.
- 2.88M, 3.5 in.

Use the **Page Up** and **Page Down** keys to scroll through the options or press **Enter** to display the sub-menu. Use the **↑↓** arrow keys to position the selector in the option you choose. Press **Enter** to accept the changes and return to the Standard CMOS Features menu.

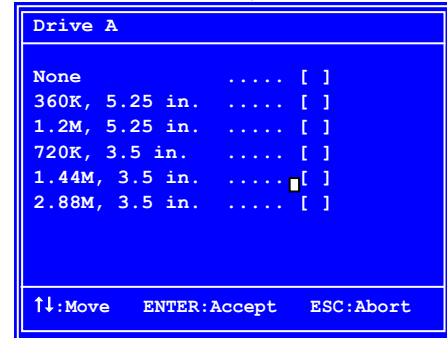

Halt On

Halt On determines whether or not the computer stops if an error is detected during power on. Use the **Page Up** and **Page Down** keys to scroll through the options or press **Enter** to display the **Halt On** sub-menu. Use the **↑↓** arrow keys to position the selector in the option you choose. Press **Enter** to accept the changes and return to the Standard CMOS Features menu.

```
Drive A      [1.44, 3.5 in.]
Halt On     [All , But Keyboard]
```

Press ENTER to display sub-menu

- All Errors**
Whenever the BIOS detects a nonfatal error, the system stops and prompts you.
- No Errors**
System boot does not stop for any detected errors.
- All, But Keyboard**
System boot does not stop for keyboard errors, but does stop for all other errors.
- All, But Diskette**
- All, But Diskette**

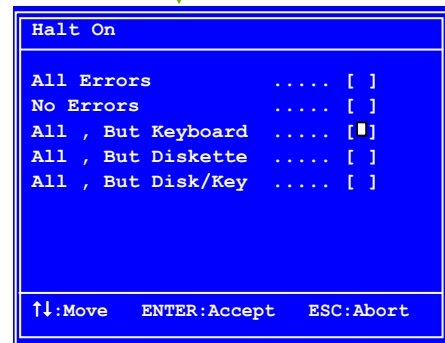

The system boot does not stop for a diskette error but will stop for all other errors.

All, But Disk/Key

The system boot does not stop for a keyboard or disk error, but will stop for all other errors.

Memory

These settings are *display-only values* that are determined by the BIOS POST (Power-On Self Test).

Base Memory	640K
Extended Memory	1047552K
Total Memory	1048576K

Base Memory

BIOS POST determines the amount of base (or conventional) memory installed in the system.

Extended Memory

BIOS determines how much extended memory is present during the POST.

Total Memory

This value represents the total memory of the system.

Advanced BIOS Features

Access the Advanced BIOS Features menu from the CMOS Utility Setup screen. Use the **Page Up** and **Page Down** keys to scroll through the options or press **Enter** to display the sub-menu. Use the **↑↓** arrow keys to position the selector in the option you choose. To go back to the previous menu, press **Esc**.

Note: The options that have associated sub-menus are designated by a ▶, which precedes the option. Press **Enter** to display the sub-menus.

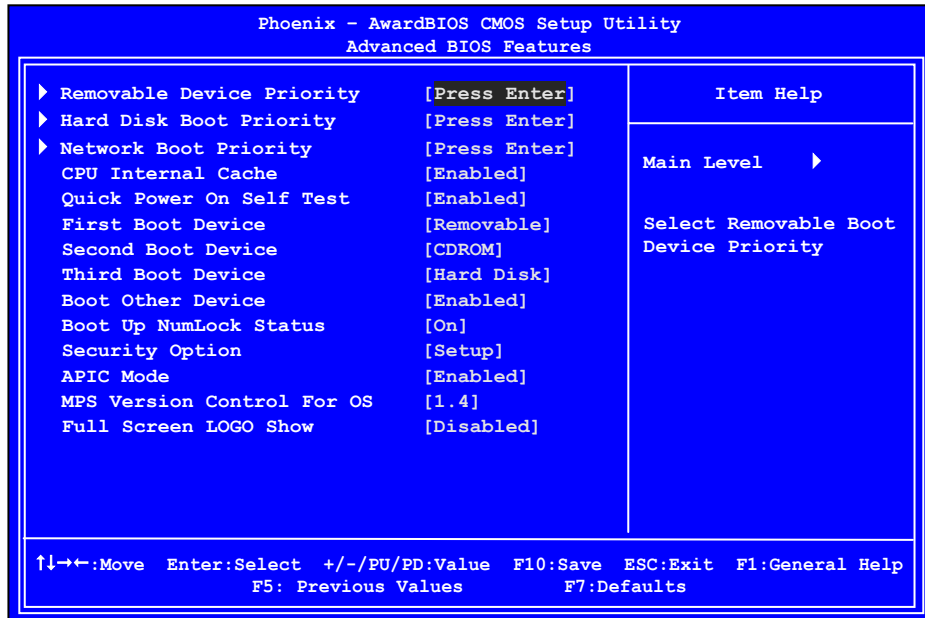

Figure 7. Advanced BIOS Features Menu

Note: Note that all data in **white** is for information only, data in **yellow** is changeable, data in **blue** is non-changeable, and data in a **red box** is highlighted for selection.

Removable Device Priority

Use this option to select the priority for removable device startup. Press **Enter** to see the list of removable devices in your system. Use the **↑↓** arrow keys to go to the various devices. Then use the **+** or **-** keys to move the device priority up or down in the list. To go back to the previous menu, press **Esc**.

```
1. Floppy Disks
```

Hard Disk Boot Priority

Use this option to select the priority for HDD startup. Press **Enter** to see the list of bootable devices in your system. Use the **↑↓** arrow keys to go to the various devices. Then use the **+** or **-** keys to move the device priority up or down in the list. To go back to the previous menu, press **Esc**.

```
1. Ch0. : ST3802110A
2. Bootable Add-in Cards
```

Use the **+** and **-** keys to move the priority of the device within the list

Network Boot Priority

Use this option to select the priority for network startup. Select **Network Boot Priority** and press **Enter** to view available networks. Use the **↑↓** arrow keys to go to the various devices. Then use the **+** or **-** keys to move the device priority up or down in the list. To go back to the previous menu, press **Esc**.

```
1. Network 0 : <description of network>
2. Network 1 : <description of network>
```

CPU Internal Cache

Use this option to enable or disable the CPU internal cache. Use the **Page Up** and **Page Down** keys to scroll through the options or press **Enter** to display the options in a sub-menu. Use the **↑↓** arrow keys to position the selector in the option you choose.

Quick Power On Self Test

Enabling this option allows the system to skip certain test while booting, which reduces the time needed to boot the system. Use the **Page Up** and **Page Down** keys to toggle between **Enable** and **Disable**.

First/Second/Third Boot Device

Use this option to set the priority sequence of the devices booted at power on. Use the **Page Up** and **Page Down** keys to scroll through the options or press **Enter** to display the sub-menu. Use the **↑↓** arrow keys to position the selector in the option you choose.

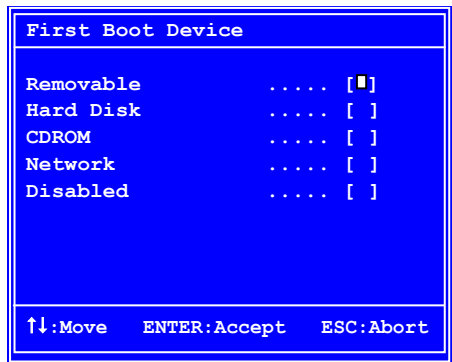

Boot Other Device

With the option set to **Enable**, the system boots from some other device if the first/second/third boot devices fail.

Boot Up NumLock Status

This option allows you to select the power-on state of **NumLock**. Select **On** to activate the keyboard **NumLock** when the system is started. Select **Off** to disable the **NumLock** key.

Security Option

The Security Options allows you to require a password every time the system boots or only when you enter setup. Select **Setup** to require a password to gain access to the CMOS Setup screen. Select **System** to require a password to access the CMOS Setup screen and when the system boots.

APIC Mode

Use this function to enable or disable the Advanced Programmable Interrupt Controller (APIC). If you disable this option, you also disable the MPS Version Control for OS option.

MPS Version Control For OS

Use this function to select the Multi-Processor Specification (MPS) version that BIOS passes to the operating system. Use the **Page Up** and **Page Down** keys to scroll through the options.

Full Screen LOGO Show

This option allows you to enable or disable the display of the full-screen logo when the system boots. Use the **Page Up** and **Page Down** keys to toggle between **Enable** and **Disable**

Advanced Chipset Features

Select **Advanced Chipset Features** from the CMOS Setup Utility menu and press **Enter** to display the functions of the Advanced Chipset Functions menu.

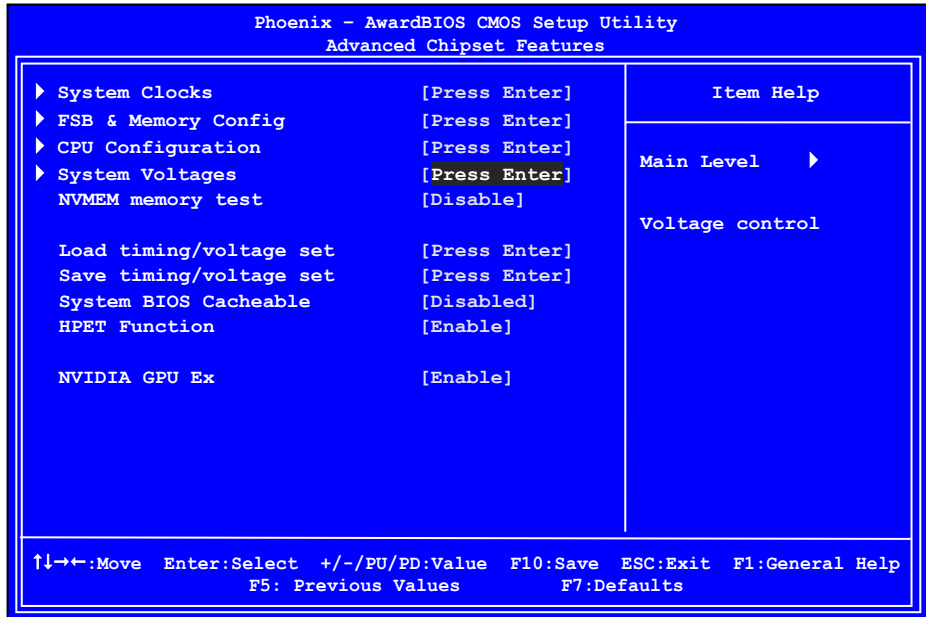

Figure 8. Advanced Chipset Features

System Clocks

Select **System Clocks** from the Advanced Chipset Features menu and press **Enter** to display the System Clocks menu. From this menu, you are able to specify frequency settings, HT multipliers, and Spread Spectrum settings. Note that in Figure 9, all of the options are listed. On the actual BIOS screen, you will need to scroll down to see all the options.

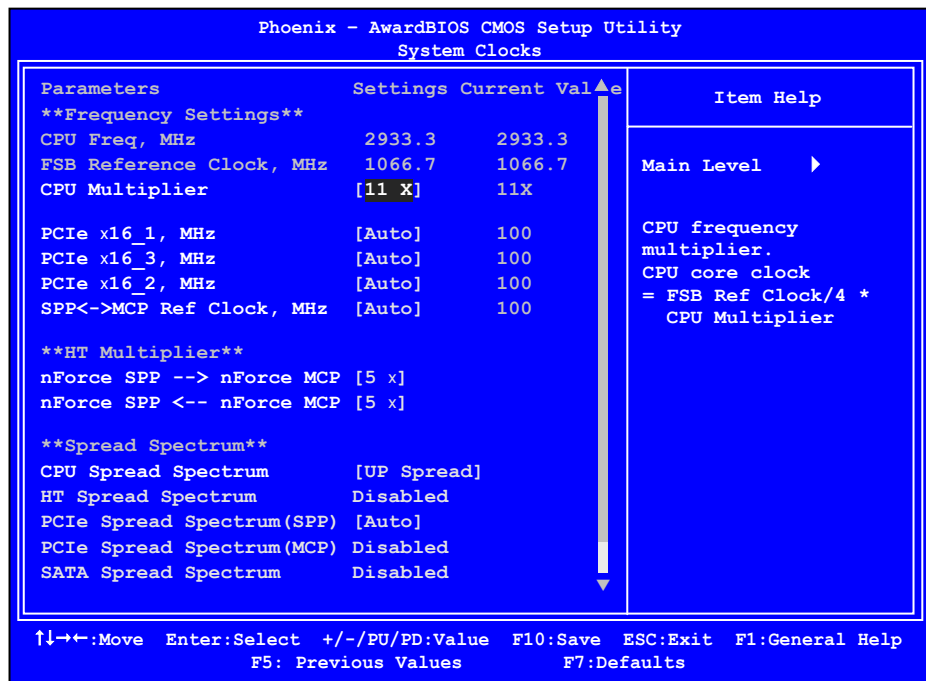

Figure 9. System Clocks Menu

Note: Note that all data in **white** is for information only, data in **yellow** is changeable, data in **blue** is non-changeable, and data in a **red box** is highlighted for selection.

Frequency Settings

- ❑ **CPU Freq, MHz**
This value is set by the CPU Multiplier (value cannot be changed by the user).
- ❑ **FSB Reference Clock, MHz**
This value is set by the system (value cannot be changed by the user). To change the SLI-Ready memory, FSB memory, and memory timing, go to the FSB & Memory screen.
- ❑ **CPU Multiplier**
This value changes the CPU Frequency value depending on the value you choose. Use the **Page Up** and **Page Down** keys to scroll through the options. The options are from 6 X through 60 X.
- ❑ **PCIe x16_1, MHz**
Use the **Page Up** and **Page Down** keys to scroll through the frequency options for the PCI Express Bus, Slot 1 (the black slot closest to the CPU). Note that as you go higher in value, **PCIe Spread Spectrum(SPP)** is disabled and cannot be changed from this status.
- ❑ **PCIe x16_3, MHz**
Use the **Page Up** and **Page Down** keys to scroll through the frequency options for the PCI Express Bus, Slot 3 (the blue slot in the middle).
- ❑ **PCIe x16_2, MHz**
Use the **Page Up** and **Page Down** keys to scroll through the frequency options for the PCI Express Bus, Slot 3 (the black slot farthest from the CPU).
- ❑ **SPP<->MCP Ref Clock, MHz**
Use the **Page Up** and **Page Down** keys to scroll through the frequency options for the reference clock between the SPP chip and the MCP chip.

HT Multiplier

- ❑ **nForce SPP → nForce MCP**
Use the **Page Up** and **Page Down** keys to scroll through the HT multiplier options and set the link speed from the SPP chip to the MCP chip. Values are [1 x] through [5 x].
- ❑ **nForce MCP ← nForce SPP**
Use the **Page Up** and **Page Down** keys to scroll through the HT multiplier options and set the link speed from the MCP chip to the SPP chip. Values are [1 x] through [5 x].

Spread Spectrum

- ❑ **CPU Spread Spectrum**
Use the **Page Up** and **Page Down** keys to scroll through the Spread Spectrum options for the CPU. Option values are [Disabled], [UP Spread], and [Center Spread].
- ❑ **HT Spread Spectrum**
Disabled
- ❑ **PCIe Spread Spectrum (SPP)**
Use the **Page Up** and **Page Down** keys to scroll through the Spread Spectrum options for the SPP PCIe. Option values are [Disabled], [UP Spread], and [Center Spread]. This option reverts to Disabled and cannot be changed when the value for PCIe x16_1 exceeds 100MHz.
- ❑ **PCIe Spread Spectrum(MCP)**
Disabled
- ❑ **SATA Spread Spectrum**
Disabled

FSB & Memory Config

Select **FSB & Memory Config** from the Advanced Chipset Features menu and press **Enter** to display the FSB & Memory Config menu. This menu provides the means to set SLI-Ready memory, FSB memory, and memory timing.

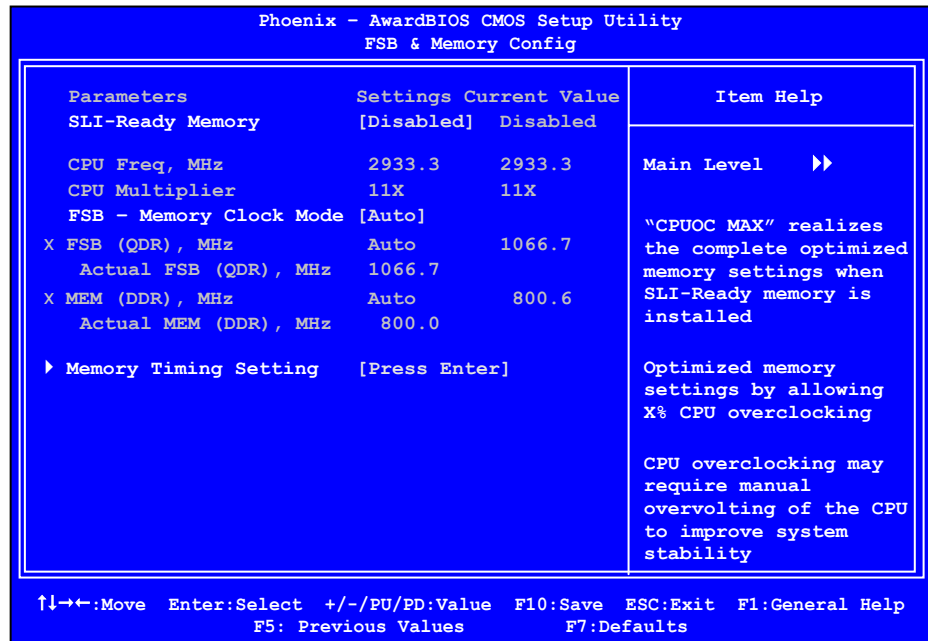

Figure 10. FSB & Memory Config Menu

❑ SLI-Ready Memory

Use the **Page Up** and **Page Down** keys to scroll through the SLI-Ready Memory options. The options are:

- Disabled
- CPUOC 0%
- CPUOC 1%
- CPUOC 2%
- CPUOC 3%
- CPUOC 4%
- CPUOC 5%
- CPUOC MAX

When you select one of the **CPUOC x%** options, the **FSB - Memory Clock Mode** is set to **Unlinked** and cannot be changed until **SLI-Ready Memory** is set to **Disable**.

❑ FSB and Memory Clock Mode

Use the **Page Up** and **Page Down** keys to scroll through the FSB and Memory Clock Mode options. The options are:

➤ Auto

This is the optimal setting since it sets the FSB and memory speeds automatically.

➤ Linked

When **Link** is selected, **FSB (QDR), MHz** is changed to editable and the FSB speed can be entered manually. As the FSB speed is changed, **CPU Freq, MHz** changes proportionally.

CPU Freq, MHz	2933.3	2933.3
CPU Multiplier	11X	11X
FSB - Memory Clock Mode	[Linked]	
FSB (QDR), MHz	[1067]	1066.7
Actual FSB (QDR), MHz	1066.7	
X MEM (DDR), MHz	Auto	800.6
Actual MEM (DDR), MHz	800.0	

➤ Unlinked

When **Unlink** is selected, **FSB (QDR), MHz** and **MEM (DDR), MHz** are changed to editable and the FSB and memory speeds can be entered manually. As the FSB speed is changed, **CPU Freq, MHz** changes proportionally.

FSB - Memory Clock Mode	[Linked]	
FSB (QDR), MHz	[1067]	1066.7
Actual FSB (QDR), MHz	1066.7	
MEM (DDR), MHz	[1067]	800.6
Actual MEM (DDR), MHz	800.0	

❑ FSB (QDR), MHz

Use the **+** or **-** keys to scroll through new values for the CPU FSB frequency or type in a new value. Note that the **Actual FSB (QDR)** reflects the actual frequency that takes effect on a reboot.

❑ MEM (DDR), MHz

Use the **+** or **-** keys to scroll through new values for the memory frequency

or type in a new value. Note that the **Actual MEM (DDR)** reflects the actual frequency that takes effect when the system reboots.

❑ **Memory Timing Setting**

Press **Enter** to display the Memory Timing Setting menu. Use this menu to set optimal timings or to manually enter timings.

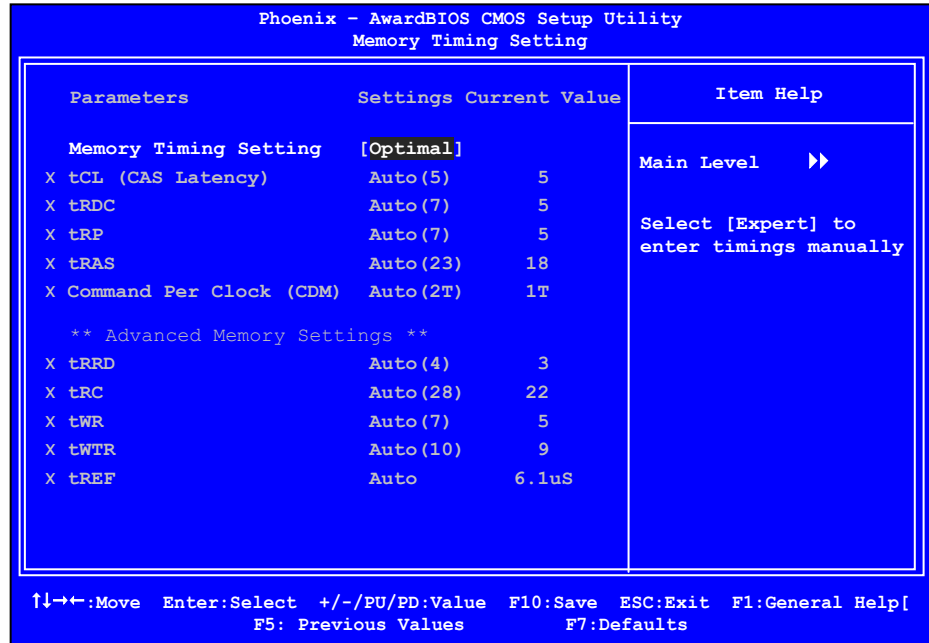

➤ **Optimal**

Use the **Page Up** and **Page Down** keys to select **Optimal**. Optimal prohibits you from manually setting any timing. All timing is set for optimal performance.

➤ Expert

Use the **Page Up** and **Page Down** keys to select **Expert**. When Expert is selected, all timing categories are enabled for manual input. Note that you should set the value to Optimal to use the manufacturers' recommended values.

Parameters	Settings	Current Value
Memory Timing Setting	[Expert]	
tCL (CAS Latency)	[Auto (5)]	5
tRDC	[Auto (7)]	5
tRP	[Auto (7)]	5
tRAS	[Auto (23)]	18
Command Per Clock (CDM)	[Auto (2T)]	1T
** Advanced Memory Settings **		
tRRD	[Auto (4)]	3
tRC	[Auto (28)]	22
tWR	[Auto (7)]	5
tWTR	[Auto (10)]	9
tREF	[Auto]	6.1uS

- ☞ **tCL**: CAS# latency (options are 1 through 6).
- ☞ **tRDC**: RAS#-to-CAS# Delay for Read/Write commands to the same bank (options are 1 through 7).
- ☞ **tRP**: Row Precharge time. This is the Precharge-to-Active or Auto-to-Refresh of the same bank (options are 1 through 7).
- ☞ **tRAS**: This is the minimum RAS# active time (options are 1 through 31).
- ☞ **Command Per Clock**: This is the command timing setting on a per clock unit basis (options are 1T and 2T).
- ☞ **tRRD**: RAS#-to-RAS# delay of different banks (options are 1 through 15).
- ☞ **tRC**: RAS#-to-RAS# or auto refresh time of the same bank (options are 1 through 31).
- ☞ **tWR**: The Write recovery time (options are 2 through 7).
- ☞ **tWTR**: This is the minimum write-to-read delay with the same chip selected (options are 1 through 10).
- ☞ **tREF**: This is the DRAM refresh rate (options are **Auto**, **7.8uS**, and **3.9uS**).

CPU Configuration

Select **CPU Configuration** from the Advanced Chipset Features menu and press **Enter** to display the CPU Configuration menu.

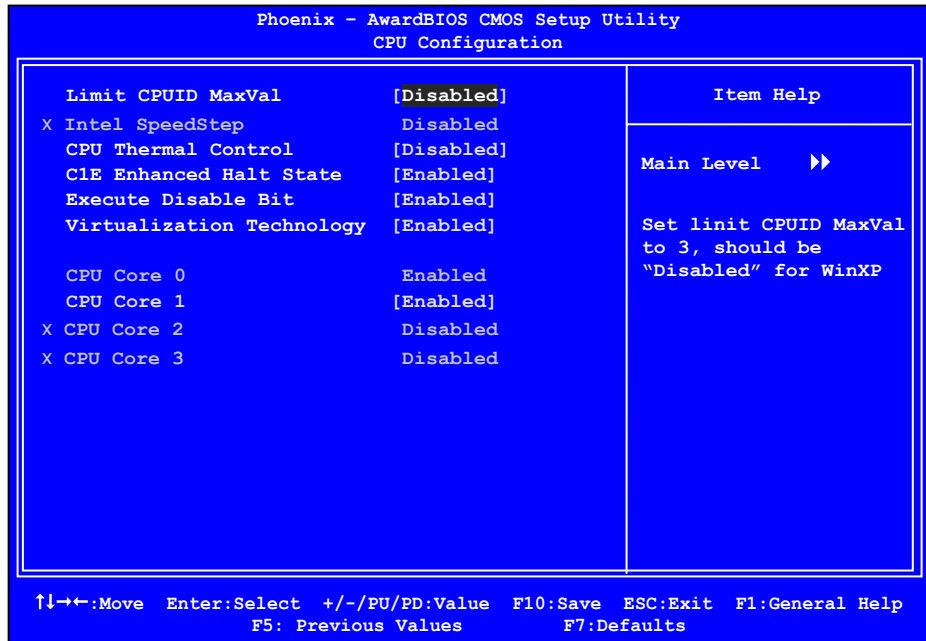

Figure 11. CPU Configuration Menu

- ❑ **Limit CPUID MaxVal**
Use this function to enable the set limit of the CPUID MaxVal to 3. Set to Disable for Win XP.
- ❑ **CPU Thermal Control**
Use this function to enable or disable TM1 and TM2 support. The options are:
 - Disable
Disable support for TM1 and TM2.
 - TM1 Only
The CPU is thermally throttled by cutting active processor clock cycles.
 - TM2 Only
Thermal throttling is achieved by reducing the CPU multiplier and CPU core voltage.

- **TM1 & TM2**
Enables support for both TM1 and TM2.
- ❑ **C1E Enhanced Halt State**
Enabled, this function reduces the CPU power consumption when the CPU is idle. Idle occurs when the operating system issues a halt instruction.
- ❑ **Execute Disable Bit**
When this function is disabled, it forces the XD feature flag to always return to zero (0).
- ❑ **Virtualization Technology**
When this function is enabled, it allows a VMM to utilize the additional hardware capabilities provided by Intel Virtualization Technology.
- ❑ **CPU Core 1**
This function allows you to enable or disable CPU Core.

System Voltages

Select **System Voltages** from the Advanced Chipset Features menu and press **Enter** to display the System Voltages menu.

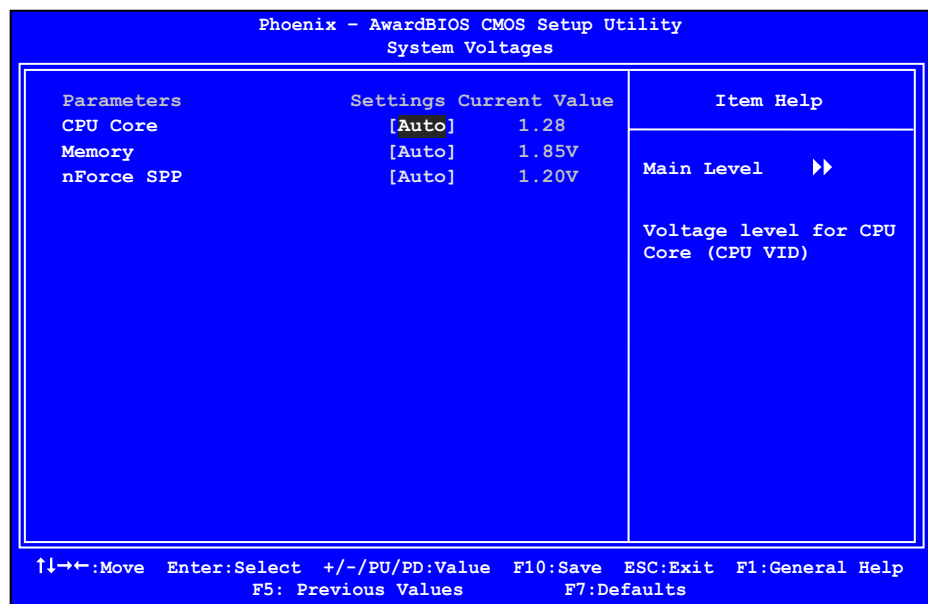

Figure 12. System Voltages Menu

- ❑ **CPU Core**
Use the **Page Up** and **Page Down** keys to scroll through the voltages or select **[Auto]** to automatically set the voltage level for the CPU Core.
- ❑ **Memory**
This function defines the voltage level for the DRAM. Use the **Page Up** and **Page Down** keys to select a voltage or select **[Auto]** to automatically set the voltage.
- ❑ **nForce SPP**
This function defines the core voltage level for the NVIDIA nForce SPP chip. Use the **Page Up** and **Page Down** keys to select a voltage (1.20V, 1.30V, 1.40V, 1.50V) or select **[Auto]** to automatically set the voltage.

NVMEM Memory Test

This function defines whether you run the NVIDIA memory testing module during POST. The options are Fast, Medium, Slow, and Disable.

Load Timing/Voltage Set

This function loads the system voltages and timing settings that were defined in the System Voltages menu. You can set up to four profile settings using the **Save timing/voltage set** function.

There are four profile options that can be loaded. The default setting is **Auto** for all settings. Press **Enter** to see the options.

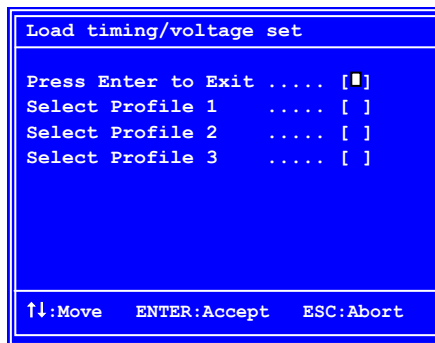

Save Timing/Voltage Set

This function saves the system voltages and timing settings that were defined in the System Voltages menu. There are four profile options that can be loaded. The default setting is **Auto** for all settings. Press **Enter** to see the options.

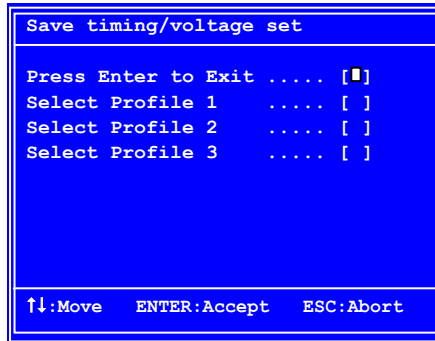

System BIOS Cacheable

This function allows you to enable or disable caching the system BIOS.

HPET Function

This function allows you to enable or disable the High Precision Even Timer (HPET). When **Enabled**, HPET is used as the timing hardware for multimedia and other time-sensitive application. When HPET is **Disabled**, the APIC timer is used.

NVIDIA GPU Ex

To enable or disable this function you need to have the NVIDIA® ForceWare® graphics driver with NVIDIA EX support. When enabled, the system uses the optimized NVIDIA EX graphics driver.

Integrated Peripherals Menu

Select **Integrated Peripherals** from the CMOS Setup Utility menu and press **Enter** to display the Integrated Peripherals menu.

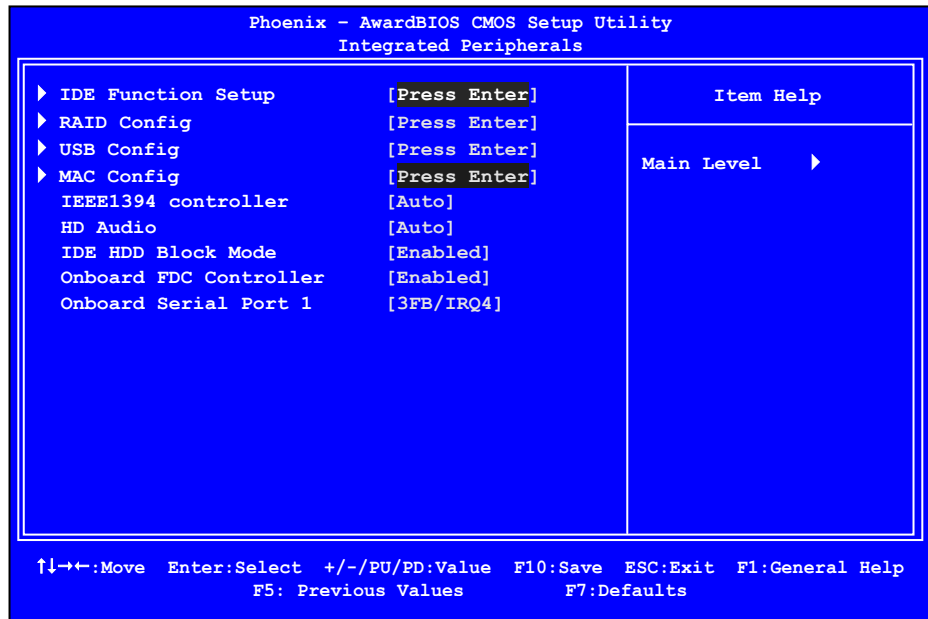

Figure 13. Integrated Peripherals Menu

IDE Function Setup

Press **Enter** to display the IDE Function Setup menu.

OnChip IDE Channel0	[Enabled]
Primary Master PIO	[Auto]
Primary Slave PIO	[Auto]
Primary Master UDMA	[Auto]
Primary Slave UDMA	[Auto]
IDE DMA transfer access	[Enabled]
Serial-ATA Controller	[All Enabled]
IDE Prefetch Mode	[Enabled]

❑ OnChip IDE Channel0

Use this function to enable or disable the onchip IDE Channel0. When disabled, the Primary Master/Slave functions are changed to **Auto** and cannot be changed.

OnChip IDE Channel0	[Disabled]
x Primary Master PIO	Auto
x Primary Slave PIO	Auto
x Primary Master UDMA	Auto
x Primary Slave UDMA	Auto
IDE DMA transfer access	[Enabled]
Serial-ATA Controller	[All Enabled]
IDE Prefetch Mode	[Enabled]

❑ Primary Master/Slave PIO

When **OnChip IDE Channel0** is set to **[Enabled]**, you can select a mode for the primary Master and Slave PIO. Select from **Auto**, or **Mode 1** through **Mode 4**.

❑ Primary Master/Slave UDMA

When **OnChip IDE Channel0** is set to **[Enabled]**, you can disable the primary Master and Slave UDMA or set it to **[Auto]**.

❑ IDE DMA transfer access

Use this function to enable or disable IDE DMA transfer access.

❑ Serial-ATA Controller

This function allows you to enable specific SATA controllers, enable all controllers, or disable all controllers. The options available are **[SATA-0]**, **[SATA-0+1]**, **[Enable All]**, and **[Disabled]**.

❑ IDE Prefetch Mode

Use this function to enable or disable the IDE Prefetch mode.

RAID Config

Press **Enter** to display the RAID Config menu.

RAID Enable		[Enabled]
SATA 0 Primary	RAID	[Disabled]
SATA 0 Secondary	RAID	[Disabled]
SATA 1 Primary	RAID	[Disabled]
SATA 1 Secondary	RAID	[Disabled]
SATA 2 Primary	RAID	[Disabled]
SATA 2 Secondary	RAID	[Disabled]

RAID Enable

Use this function to enable or disable RAID. When RAID is set to **[Disabled]**, all SATA functions are changed to **Disabled** and cannot be changed.

RAID Enable		[Disabled]
x SATA 0 Primary	RAID	Disabled
x SATA 0 Secondary	RAID	Disabled
x SATA 1 Primary	RAID	Disabled
x SATA 1 Secondary	RAID	Disabled
x SATA 2 Primary	RAID	Disabled
x SATA 2 Secondary	RAID	Disabled

SATA x Primary/Secondary

When **RAID Enable** is set to **[Enabled]**, you can enable or disable the various SATA functions.

USB Config

Press **Enter** to display the USB Config menu.

OnChip USB		[Enabled]
USB Keyboard Support		[Disabled]
USB Mouse Support		[Disabled]

OnChip USB

Use this function to enable specific versions of the USB or disable the onchip USB.

When the onchip USB is set to **[Disabled]**, the keyboard and mouse support functions are set to **Enabled** and cannot be changed. Versions that can be selected are **[V1.1+V2.0]** or **[V1.1]**.

OnChip USB		[Disabled]
x USB Keyboard Support		Enabled
x USB Mouse Support		Enabled

USB Keyboard/Mouse Support

Use these function to enable or disable the onchip WSB support of the keyboard and/or mouse.

MAC Config

Press **Enter** to display the MAC Config menu.

MAC0 LAN	[Enabled]
MAC1 LAN	[Disabled]

MACx LAN

Use these functions to set the MAC0 and/or MAC1 LANs to **Auto** or disable their functions.

IEEE1394 controller

This function on the Integrated Peripherals menu allows you to enable or disable the IEEE1394 (Firewire) interface.

HD Audio

This function on the Integrated Peripherals menu allows you to enable or disable the audio function.

IDE HDD Block Mode

Using this function on the Integrated Peripherals menu allows your IDE hard drive needs to support block mode. Select **[Enabled]** to automatically detect the optimal number of block read/writes per sector the drive can support. Select **[Disabled]** if your drive does not support block mode.

Onboard FDC Controller

This function on the Integrated Peripherals menu allows you to enable or disable the onboard FDC controller function.

Onboard Serial Port 1

This function on the Integrated Peripherals menu allows you to select the onboard serial port 1 function. Options are **[3F8/IRQ4]**, **[2E8/IRQ3]**, **[3E8/IRQ4]**, **[Auto]**, and **[Disabled]**.

Power Management Setup Menu

Select **Power Management Setup** from the CMOS Setup Utility menu and press **Enter** to display the Power Management Setup menu.

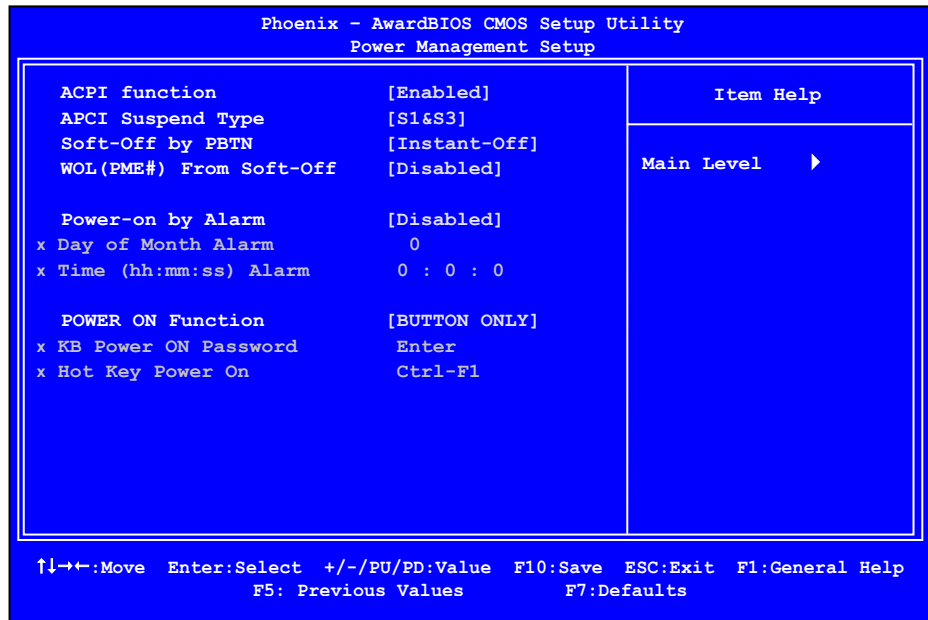

Figure 14. Power Management Setup Menu

ACPI Function

This function on the Power Management Setup menu allows you to enable or disable the ACPI function.

ACPI Suspend Type

This function on the Power Management Setup menu allows you to select an ACPI Suspend Type. Types to select from are **[S1&S3]**, **[S1 (POS)]**, and **[S3 (STR)]**.

Soft-Off by PBNT

This function on the Power Management Setup menu allows you to set Soft-Off by PBNT to **[Instant-Off]** or **[Delay 4 Sec]**.

WOL(PME#) From Soft-Off

This function on the Power Management Setup menu allows you to enable or disable WOL(PME#) from soft-off.

Power On by Alarm

This function on the Power Management Setup menu allows you to enable or disable the Power-on by alarm function. Set to **[Disable]** to prevent power-on by alarm. When set to **[Enable]**, you can manually put in the day of the month and the time of the alarm.

```
Power-on by Alarm      [Disabled]
Day of Month Alarm     [ 0]
Time (hh:mm:ss) Alarm [0 : 0 : 0]
```

To enter a day or time, use the **Page Up** and **Page Down** keys to scroll through numbers or enter the number using the keyboard number or the **+** and **-** keys.

POWER ON Function

This function on the Power Management Setup menu allows you to define the power-on function. Options for this function are:

- BUTTON ONLY
- Keyboard 98
- Password**

When **[Password]** is selected, the **KB Power ON Password** function is enabled so that you must enter a password.

```
POWER ON Function      [Password]
KB Power ON Password   [Enter]
x Hot Key Power On     Ctrl-F1
```

Hot Key Power On

When **[Hot Key]** is selected, the **Hot key Power On** function is enabled so that you must select a keyboard key as the hot key. To select a hot key use **Ctrl+F1** though **Ctrl+F12**.

POWER ON Function	[Hot key]
x KB Power ON Password	Enter
Hot Key Power On	[Ctrl-F1]

Mouse Left

Mouse Right

Any Key

PnP/PCI Configuration Menu

Select **PnP/PCI Configuration** from the CMOS Setup Utility menu and press **Enter** to display the PnP/PCI Configuration menu.

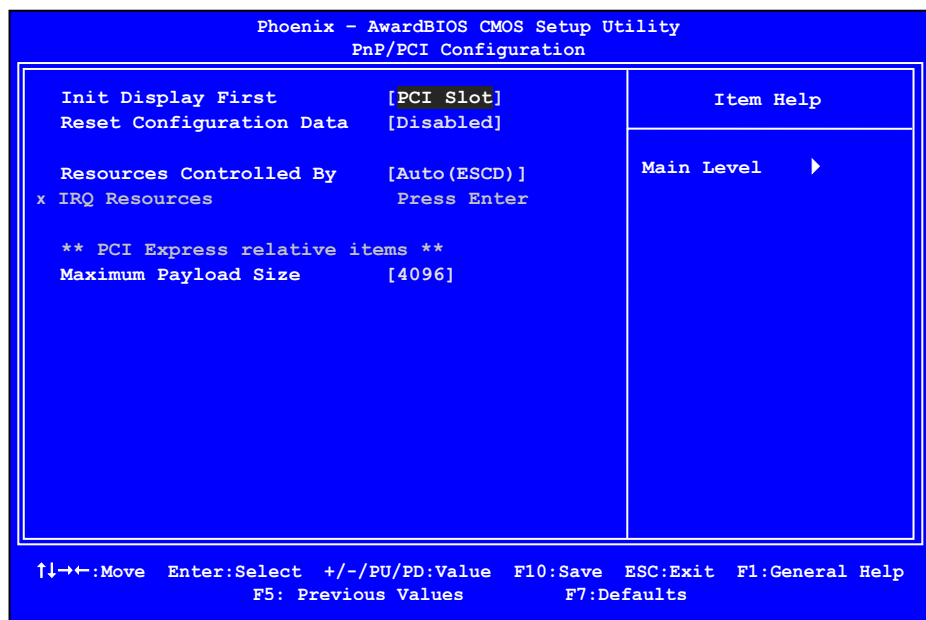

Figure 15. PnP/PCI Configuration Menu

Init Display First

This function on the PnP/PCI Configuration menu allows you to define if the initial display is in the PCI slot or in the PCI Express slot. Options are **[PCI Slot]** and **[PCIEx]**.

Reset Configuration Data

This function on the PnP/PCI Configuration menu allows you to enable or disable the resetting of Extended System Configuration Data (ESCD) when you exit Setup. Set this to **[Enabled]** if you have installed a new add-on and the system reconfiguration has caused a serious conflict that prevents the OS from booting. The default setting is **[Disabled]**.

Resources Controlled By

This function on the PnP/PCI Configuration menu allows you to define if the BIOS can automatically configure all the boot and plug-and-play compatible devices or if you can manually select IRQ, DMA, and memory base address fields. Select **[Auto (ESCD)]** if you want the BIOS to automatically populate these fields. If you select **[Manual]** so you can assign the resources, **IRQ Resources** is enabled for input.

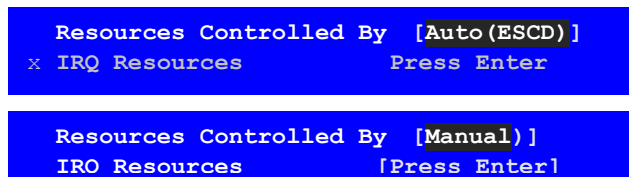

IRQ Resources

To enable this field for input, set **Resources Controlled By** to **[Manual]**. With this field enabled, press **Enter** to see options.

```
IRQ-5 assigned to [PCI Device]
IRQ-9 assigned to [Reserved]
IRQ-10 assigned to [PCI Device]
IRQ-11 assigned to [PCI Device]
IRQ-14 assigned to [PCI Device]
IRQ-15 assigned to [PCI Device]
```

Use Legacy ISA for devices compliant with the original PC AT Bus specification. Use PCI/ISA PnP for devices compliant with the plug-and-play standard, whether designed for PCI or ISA Bus architecture.

PCI/VGA Palette Snoop

This function on the PnP/PCI Configuration menu allows you to enable or disable the Palette Snoop function.

Maximum Payload Size

This function on the PnP/PCI Configuration menu allows you to set the maximum TLP payload size (in bytes) for the PCI Express devices. Use the **Page Up** and **Page Down** keys to scroll through sizes or enter the number using the keyboard numbers or use the **+** and **-** keys to go up and down the list of sizes.

System Monitor Menu

Select **System Monitor** from the CMOS Setup Utility menu and press **Enter** to display the System Monitor menu.

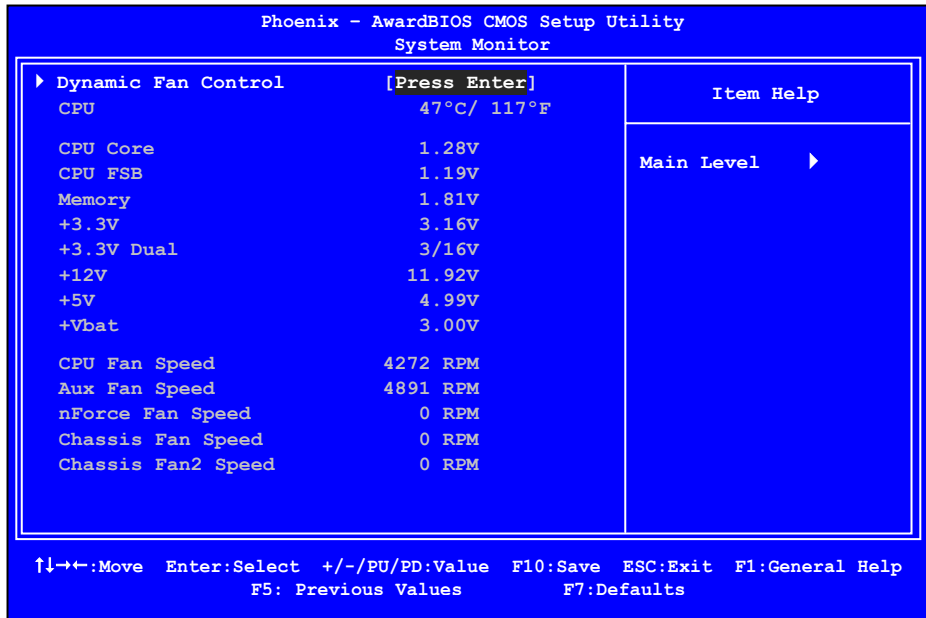

Figure 16. System Monitor Menu

All of the values shown in **Blue** are dynamic and change as the speed and voltages of the various components change with system usage.

Dynamic Fan Control

Press **Enter** to display the Dynamic Fan Control menu.

```
CPU Fan Speed Control      [SmartFan]
If temp > 70°C, Set Fan Speed 100%
If temp < 30°C, Set Fan Speed  0%
x Manual Fan Speed, %      100

AUX Fan Speed Control, %  [100]
nForce Fan Speed Control, % [100]
Chassis Fan Speed Control, % [100]
```

Use this menu to control the speed of the various fans on the motherboard. Set CPU fan speed to **[SmartFan]** when you want the speed of the fans automatically controlled based on temperature. To set the fan speed to a constant rate, select **[Manual]** and then enter the speed from 0% to 100%.

Set the desired speed for the Aux, nForce, and Chassis fans from 0% to 100%. The system defaults to 100%.

Installing Graphics Cards in an SLI Configuration

NVIDIA SLI (Scalable Link Interface) is a revolutionary technology that allows two NVIDIA SLI graphics cards to work together to deliver incredible 3D graphics performance.

Your new motherboard can support up to two PCI Express graphics cards linked using SLI.

Building an SLI System

Determine Component and Operating System Needs

To build an NVIDIA SLI system, you are going to need the following components:

- ❑ AN NVIDIA SLI-ready nForce motherboard
- ❑ Two NVIDIA SLI-Ready certified PCI Express graphics cards (with matching GPUs)
- ❑ An NVIDIA SLI-Ready power supply

For a complete list of certified components and a matrix to determine the power supply required for your particular graphic cards, go to:
<http://www.slizone.com/content/slizone/build.html>.

While NVIDIA recommends an SLI-Ready power supply, the following table provides some general power supply recommendations based on testing performed in the NVIDIA SLI validation lab.

Table 6. Recommended Power Supplies

NVIDIA SLI System Type	Minimum Recommended PCI Express Power Supply
Extreme SLI PC	NVIDIA has tested the majority of power supplies in this high power category and therefore only recommends an SLI-ready power supply.
Ultra High-end SLI PC	You must have a power supply that can provide a minimum of +12V @ 22A of dedicated power for the two graphics cards. Of this 22A requirement, +12V @ 5.5A must be available to each of the two PCI Express 6-pin auxiliary power supply connectors. The remaining 11A must be supplied to the motherboard for dedicated graphics card use.
High-end SLI PC	Minimum of 500-600W Power Supply with a minimum of +12V @ 30A for all PC components.
Mid-range SLI PC	Minimum of 450-500W Power Supply with a minimum of +12V @ 26A for all PC components.
Entry-level SLI PC	Minimum of 400-450W Power Supply with a minimum of +12V @ 22A for all PC components.

If the power supply specifies two 12V windings (i.e. 12V1 and 12V2), add these numbers together to check against the specifications described above.

For systems with the 8800 GTX or 8800 GTS, please make sure the power supply also contains PCI Express auxiliary power supply connectors. If your power supply does not have a PCI Express auxiliary connector (6-pin connector), please contact your graphics board partner for an HDD-to-PCI Express power adaptor.

The NVIDIA SLI power supply recommendations are based on the following test configurations:

- Extreme SLI PC Configuration:
 - Dual GeForce 8800 GTX or 8800 GTS Graphics cards
 - Intel Core 2 Quad Extreme
 - EVGA nForce 680 SLI
 - 2GB system memory
 - Two HDDs in Raid 0 configuration

- Two optical drives
- PCI Sound Card
- LCD at 2560x1600 resolution
- ❑ Ultra High-End SLI PC Configuration:
 - Dual GeForce 7900 GTX or Dual GeForce 7800 GTX 512MB
 - AMD Athlon 64 FX-60 2.6 GHz or Intel Pentium EE 955 3.46 GHz
 - NVIDIA nForce4 SLI X16 motherboard with 2GB system memory
 - Two HDDs in Raid 0 configuration
 - Two optical drives
 - PCI Sound Card
 - LCD at 1600x1200 resolution
- ❑ High-End SLI PC Configuration:
 - Dual GeForce 7800 GTX 256MB or Dual GeForce 6800 Ultra
 - AMD Athlon 64 FX-57 2.8 GHz or Intel Pentium EE 840 3.2 GHz
 - NVIDIA nForce4 SLI X16 motherboard with 2GB system memory
 - Two HDDs in Raid 0 configuration
 - Two optical drives
 - PCI sound card
 - LCD at 1600x1200 resolution
- ❑ Mid-Range SLI PC Configuration:
 - Dual GeForce 7900 GT or Dual GeForce 6800 GT or Dual GeForce 6800
 - AMD Athlon 64 4000+
 - NVIDIA nForce4 SLI motherboard with 1GB system memory
 - Single HDD
 - Two optical drives
 - PCI sound card
- ❑ Entry-Level SLI PC Configuration:
 - Dual GeForce 7600GT or Dual GeForce 6600 GT or Dual GeForce 6600
 - AMD Athlon 64 4000+
 - NVIDIA nForce4 SLI motherboard with 1GB system memory
 - Single HDD
 - One optical drive

For a list of certified power supplies, go to <http://www.slizone.com/content/slizone/build.html>.

Install Your NVIDIA SLI-Ready Parts

Now that you have obtained the necessary NVIDIA SLI-Ready parts, and confirmed your power supply requirements, it is time to configure the system.

This procedure assumes you have already installed the motherboard. The EVGA nForce 680i LT SLI motherboard has two PCI Express slots used for the SLI configuration.

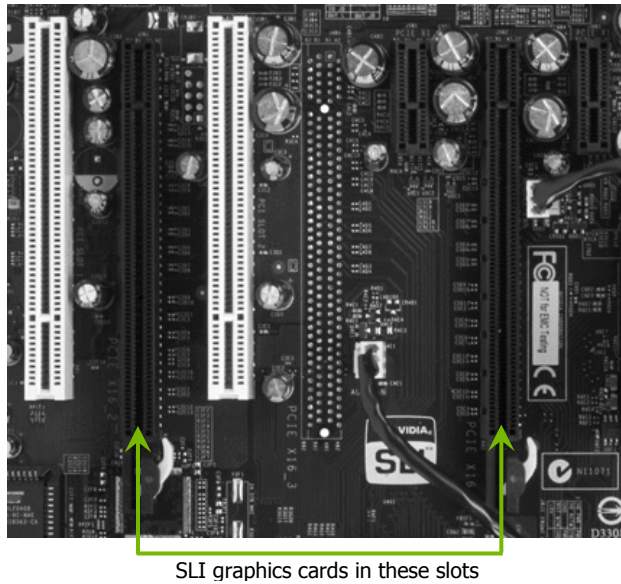
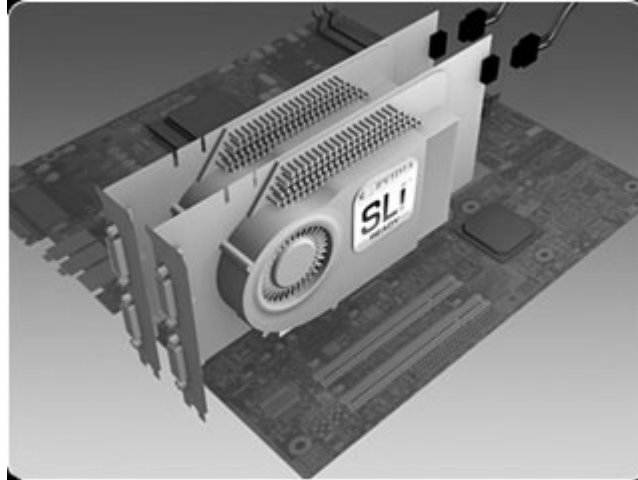

Figure 17. SLI Slots on the Motherboard

Use the following procedure to build your NVIDIA SLI-Ready PC system:

1. Install two SLI-Ready graphic cards into the two black PCI Express x16 slots on the motherboard (see Figure 29). Be sure to seat the graphic cards into the connectors.



Two SLI graphics cards installed in the two (black) PCI Express slots on the motherboard.

2. Connect the PCI Express supplementary power connectors from the system power supply to each of the graphic cards:

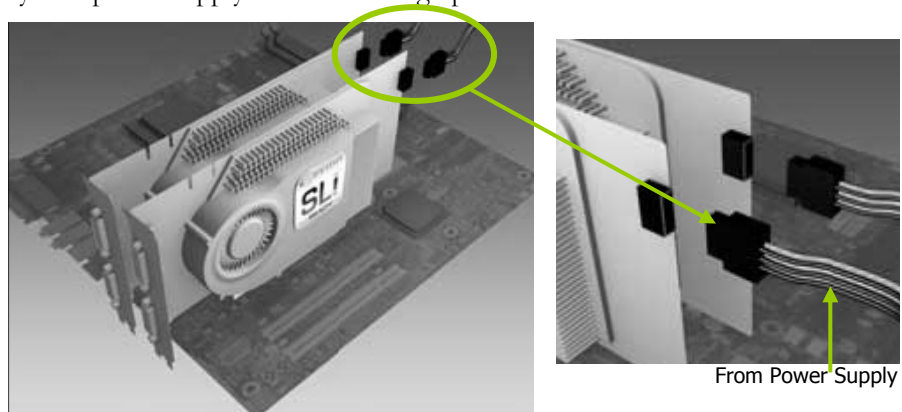

3. Install the NVIDIA SLI connector across the two outer graphics cards as shown below. Each SLI-Ready graphics card has an SLI *finger* on the upper side of the card.

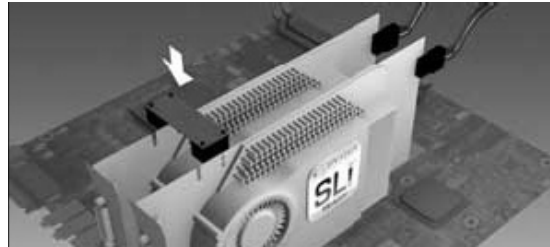

Install the SLI connector onto the two outer cards.

Install NVIDIA SLI Software

Upon power up, the operating system recognizes the new NVIDIA SLI-Ready components and displays the **Found New Hardware** message.

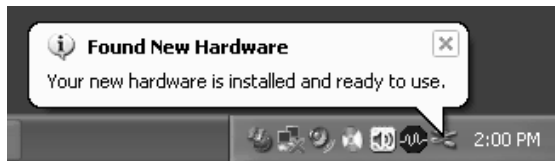

Your motherboard shipped with a set of drivers that you must install. To check for the latest drivers, go to <http://www.slizone.com/content/slizone/drivers.html> and download the latest SLI graphics drivers.

Once you have installed the NVIDIA SLI components and booted up your system, do the following:

1. Install the nForce drivers (provided with the motherboard)
2. Reboot the system
3. Uninstall any old NVIDIA graphics drivers from the system and reboot the computer. If there are no NVIDIA drivers installed, go to Step 4
4. Install the latest NVIDIA graphics drivers (provided with the add-in cards or from the SLIZone Downloads Page)
5. Reboot the system.

After reboot of the system to the Windows desktop, you will see an SLI Capable System message.

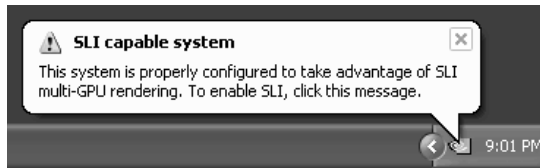

Click on this message to enable your NVIDIA SLI.

Enable NVIDIA SLI

At this point, you need to enable NVIDIA SLI. You can do this either by clicking on the **SLI capable system** balloon or by going to the NVIDIA Control Panel.

To launch the NVIDIA Control Panel, select **Start > All Programs > NVIDIA Corporation > NVIDIA Control Panel**. Click on the **3D Settings** icon.



Select **Set SLI configuration** from under **Performance**.

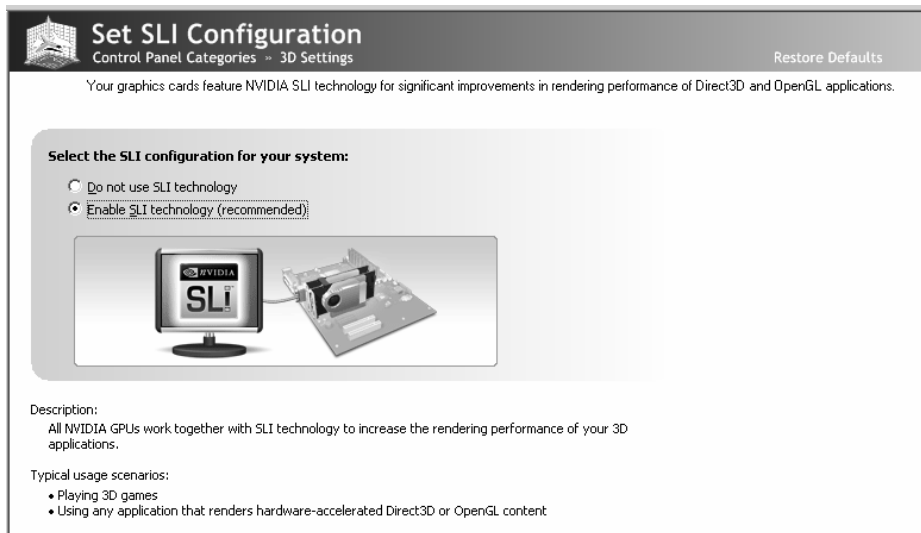

Click **Enable SLI technology (recommended)** and click **Apply**.

You now have an NVIDIA SLI-enabled PC!

The system reboots to apply the setting and display the following message upon reboot:

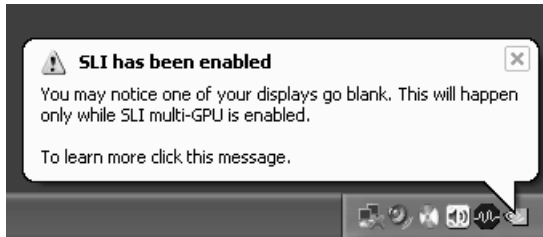

Congratulations on your new NVIDIA SLI-Ready PC system.